

FERRIMAX

luxury edition

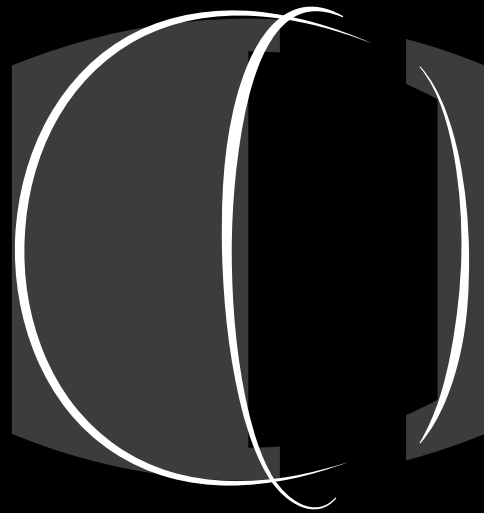



index

Introduction	5
Traveler by Colección Alexandra	11
Zendo	23
Lira	31
Argia	39
Interior finishes	49
Extrerior finishes	53
Locks	71



introduction

introduction

Introduction

Our range of Luxury Edition safes is the result of our passion for what we do and our more than forty years of experience manufacturing security elements for companies and individuals.

Every day, we improve our safes to meet the highest standards of security and always offering the highest quality. Our motivation has always been to protect what have an incalculable value, those objects whose sentimental value makes them irreplaceable, regardless of what it is: jewellery, fountain pens, watches, etc...

In this exclusive range of safes, we have selected the most exquisite interiors and finishes, making them unique luxury pieces.

Their carefully chosen designs and materials, worked down to the last detail, elevate Ferrimax Luxury Edition safes to the level of what they hold inside.

*Luxury and safety united in
an exclusive product range*

A unique space in the heart of Barcelona

Our showroom located in Barcelona offers us an exclusive environment in which the customer can choose all the details of their safe.

A unique space with architectural elements characteristics of the area, with great visual and cultural value, which gives to it a lot of character.

On the main floor of the local there is an exhibition area where you can know each pieces that make up the collection. We have also created a Customer Experience area, where you can configure them according to your personal needs, style or preferences, and see samples of all the customisation options available.

Finally, we have a more versatile space in the basement, where you can hold meetings or even relax in the lounge area.



luxury edition





products



Traveler

Traveler

Traveler by Colección Alexandra

The Traveler high security safe is unquestionably a luxury piece of jewellery made with handcrafted methods and using the highest quality materials.

A collaboration with our partner *Colección Alexandra*, which makes Traveler a masterpiece of design and elegance.

A masterpiece in terms of design and elegance



Traveler

The perfect fusion between security and elegance



EXCLUSIVITY AND CUSTOMISED DESIGN

The Traveler safe allows you to personalise the interior configuration and the exterior plating, adapting perfectly to any of our customer's needs.

The interior drawers can be configured with different storage compositions to accommodate all types of contents, such as jewellery, watches, money, weapons, documents and other precious objects.

SECURITY

The Traveler safe has been developed according with the security standard for safes EN 1143-1, obtaining the security Grade IV. Incorporates an electronic locking system and a Class B EN-1300 key lock. Also available with delay locking function.







Traveler

DIMENSIONS

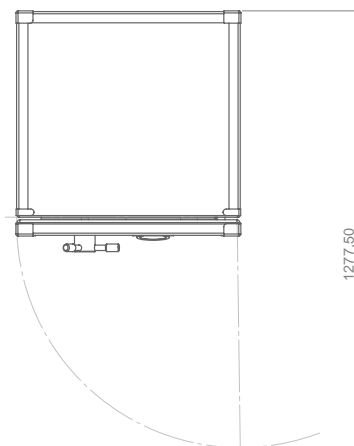
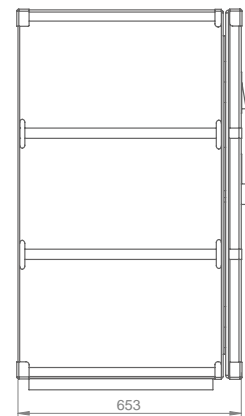
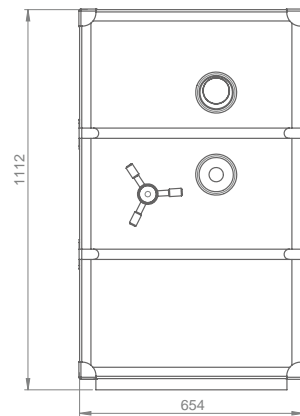

Traveler

DETAILS AND FINISHES



This line allows customisation of all these components:

1. Main exterior finish
2. Main interior finish
3. Secondary interior finish
4. Corner pieces and joints
5. Corner pieces
6. Metal details
7. Rivets

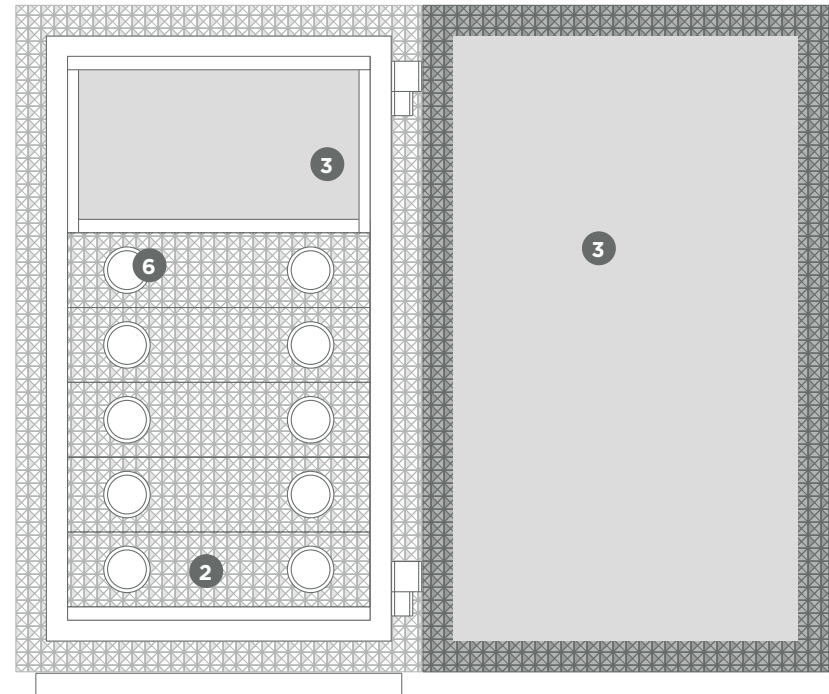
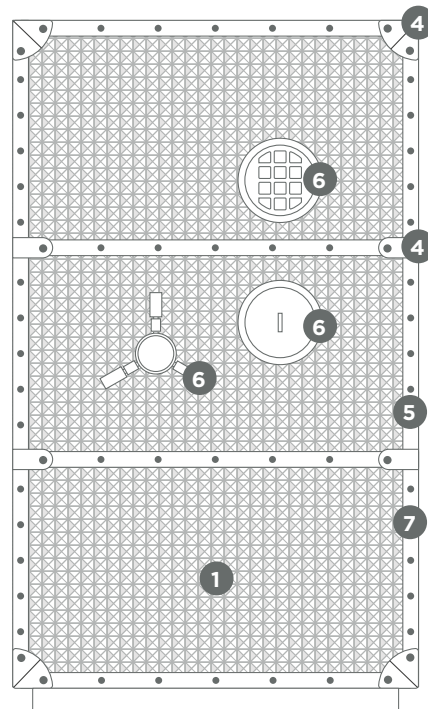

Traveler

DETAILS AND FINISHES

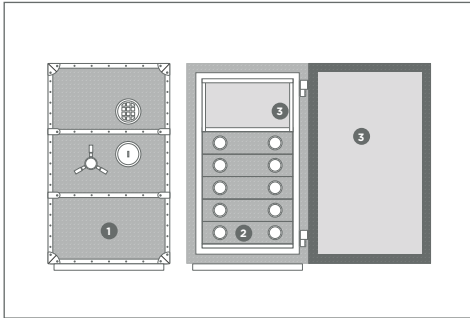

1 MAIN EXTERIOR FINISHES

2 MAIN INTERIOR FINISHES

SELECTION OF NATURAL LEATHERS



1.01T
WHITE

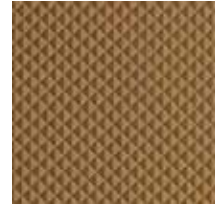

1.02T
LIGHT BROWN



1.03T
MEDIUM BROWN



1.04T
DARK BROWN



1.05T
BEIGE

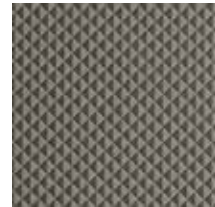

1.06T
STONE GREY

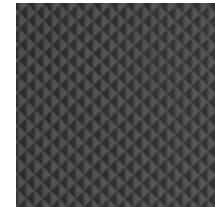

1.07T
MEDIUM GREY

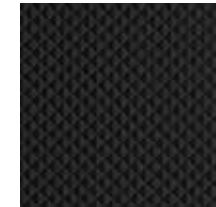

1.08T
BLACK



1.09T
DEEP BLUE

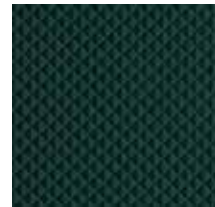

1.10T
DARK GREEN

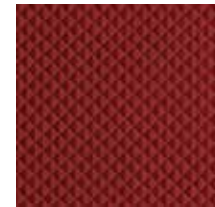

1.11T
RED

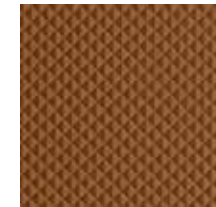

1.12T
CAMEL

3 SECONDARY INTERIOR FINISHES

VELVET SELECTION



2.01T
WARM WHITE



2.02T
OLD GOLD



2.03T
ANTHRACITE



2.04T
THEATER RED

WOOD SELECTION



3.01T
ALBINE OAK



3.02T
MEDIUM WALNUT

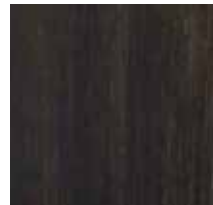

3.03T
DARK EBONY



3.04T
EXOTIC EBONY





DETAILS AND FINISHES

4 CORNERS AND JOINTS

5 CORNER PIECES

NATURAL LEATHERS SELECTION



4.05T
PEARL

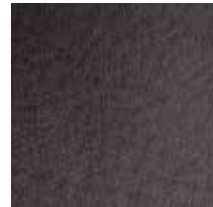

4.04T
CHARCOAL

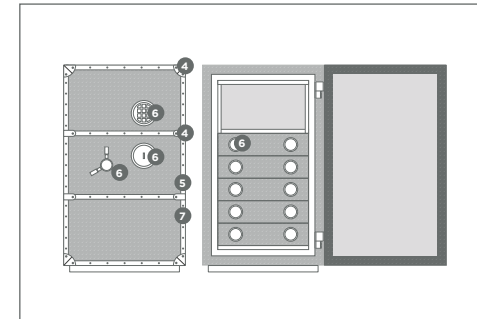

6 METAL DETAILS

7 RIVETS

METAL SELECTION

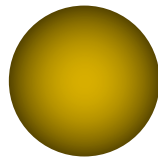

5.01T
GOLD

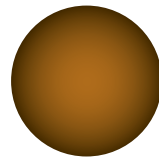

5.02T
COOPER

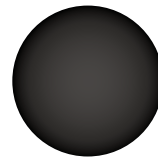

5.03T
BLACK

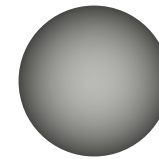

5.04T
MATT SILVER

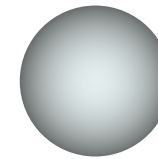

5.05T
CHROME

Traveler



Its endless possibilities make itself the perfect complement to any environment.



rendo

zendo

Zendo

The Zendo certified safe is characterised by its high level of resistance and security against burglary.

With its elegant and modern design, each safe is a unique and essential element to protect your most special objects.

Protect your most
precious values



Safety and luxury united in one exquisite piece

The Zendo safe is certified in accordance with current security standards, making it a practically impenetrable safe.

All models are certified according with the EN 1143-1 standard, which classifies the degree of burglary resistance of safes, meeting the requirements for grades III or IV and being certifying by external certified bodies.

They also include in their design other security elements that further increase their resistance, such as anti-drilling protection in the mechanisms, bolts, relockers and certified high security locks. Finally, their hinges are anti-picking and, in case of direct attack, they block the door and prevent it from being opened.





Zendo

MODELS

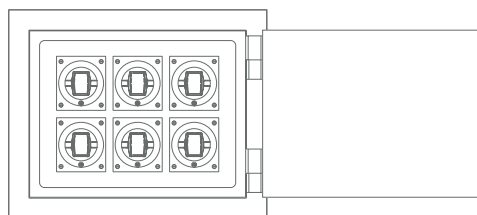

Zendo S

6 modules

525 x 425 x 415 mm (width, height, depth)

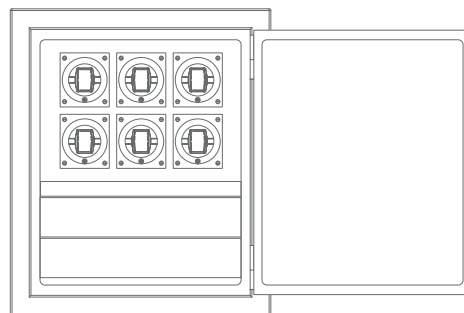

Zendo M

6 modules
1 shelf and 2 drawers

535 x 625 x 470 mm (width, height, depth)

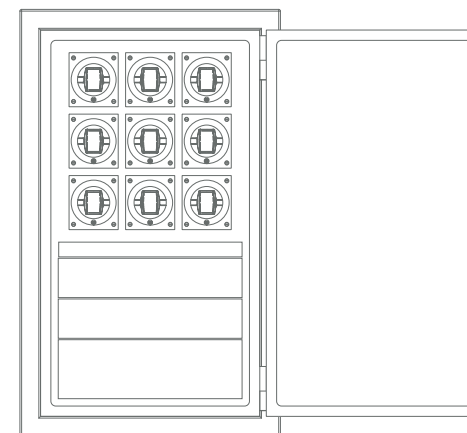

Zendo L

9 modules
1 shelf and 3 drawers

530 x 870 x 500 mm (width, height, depth)

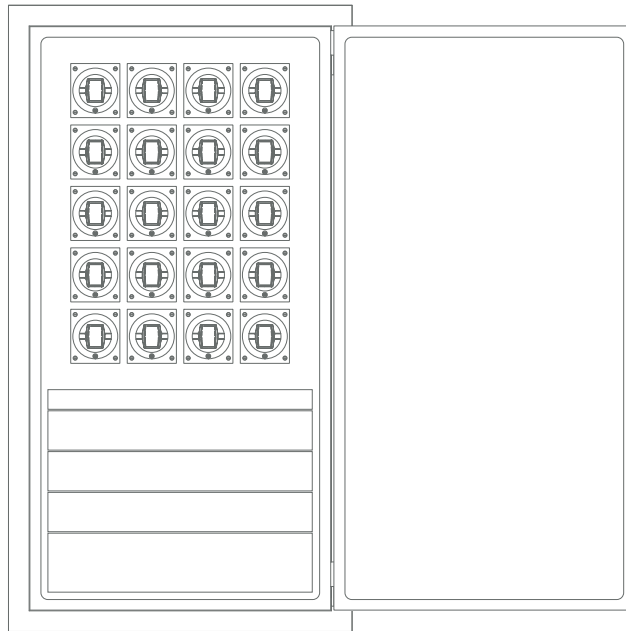

Zendo XL

20 modules
1 shelves and 5 drawers

695 x 1.270 x 590 mm (width, height, depth)





CONFIGURATION AND CUSTOMISATION

The Zendo serie is very versatile and can be adapted until the last detail. In terms of exterior finishes, it is possible to apply leather, paint or wood (see page 53).

As for the interior configuration of the space, it is fully customisable in all the models, allowing the insertion of automatic rotor modules for watches, modules for displaying jewellery, drawers with a personalised interior layouts (see page 49) and with standard or double capacity, as well as practical trays in which to deposit the pieces while the case remains open.

The safe allows customisation of all these components and also exterior and interior finishes.

1. Hinges
2. Metal details
3. Exterior door
4. Exterior safe
5. Interior door
6. Interior secondary
7. Interior modules
8. Interior trim

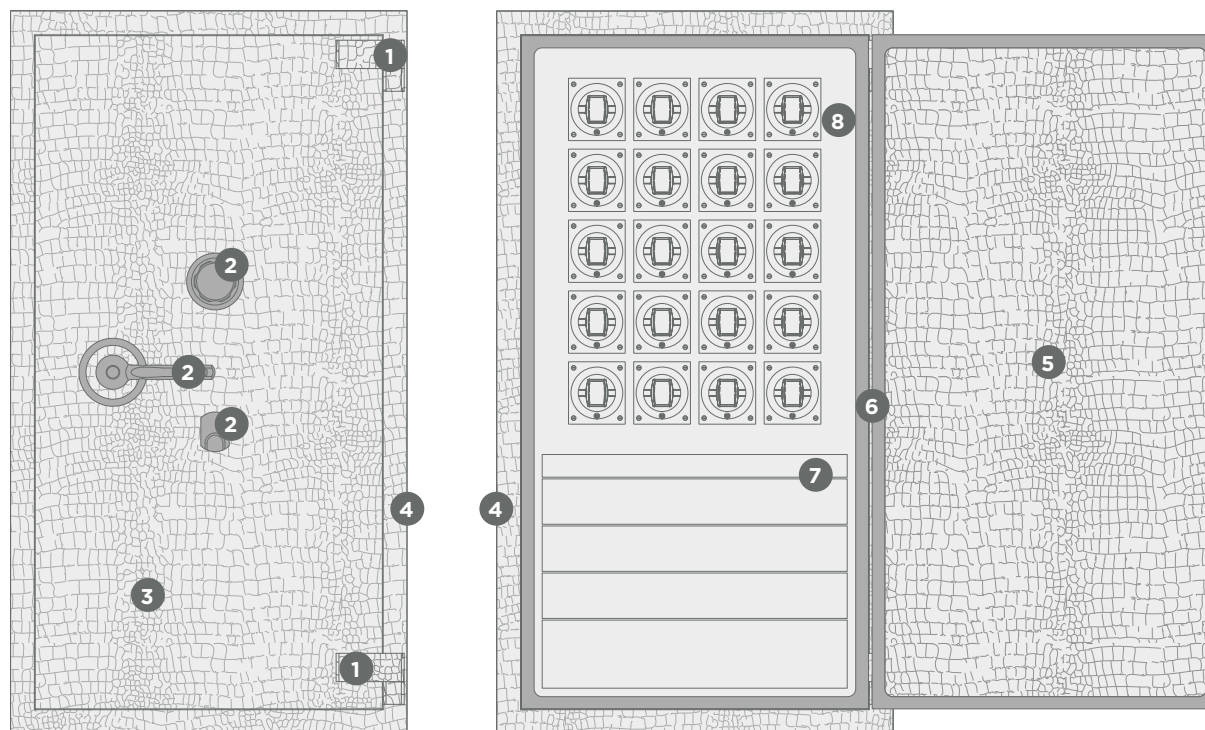



Lira

Lira

Lira is a practical, lightweight watch and jewellery safe, designed in vertical format, ideal for displaying your most precious goods.

Its exclusive and timeless style joint to its slim shape, turn itself into a decorative element perfect for any environment.



Can't hide the passion and enthusiasm
for jewellery and watches

Lira

An exclusive piece that will be part of the decoration

The Lira range has been designed with a slight tilt for easy viewing and handling its interior.

The different models have a specific number of modules that can be fully customised, with a choice of drawers, static supports or motorised rotors for watches.

The version with a glass door (optional) allows to display the contents as if they were a piece of art.





DETAILS THAT MATTER

Unique pieces have a higher value. That's why Lira allows you to personalise the lock trim and engrave your initials on it.



ALWAYS IN MOTION

Its modular configuration allows the installation of automatic winding chargers for wristwatches to ensure that your mechanisms are never interrupted.



OWN SHINE

Make your pieces stand out with the interior lighting included in all our Lira safes. It also allows you to adjust the level of warmth and activate the light by remote control.

Lira

MODELS

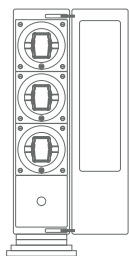

Lira 4

4 modules
1 column

116 x 504 mm

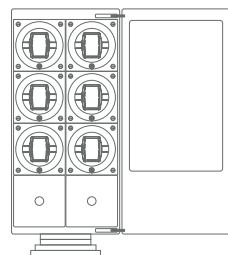

Lira 4DUO

4 modules
1 column

230 x 540 mm

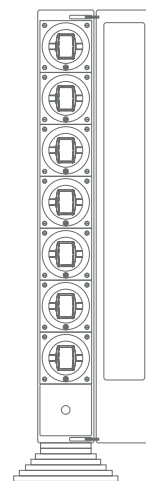

Lira 8

8 modules
1 column

116 x 952 mm

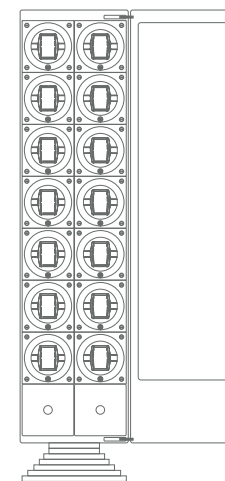

Lira 8DUO

8 modules
2 columns

230 x 980 mm

Lira 16
8 modules - 1 column
116 x 1.849 mm

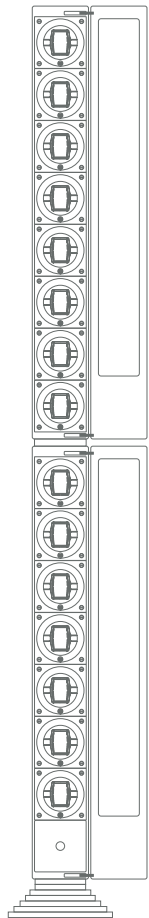

Lira 16DUO
2 modules - 2 columns
230 x 1.889 mm

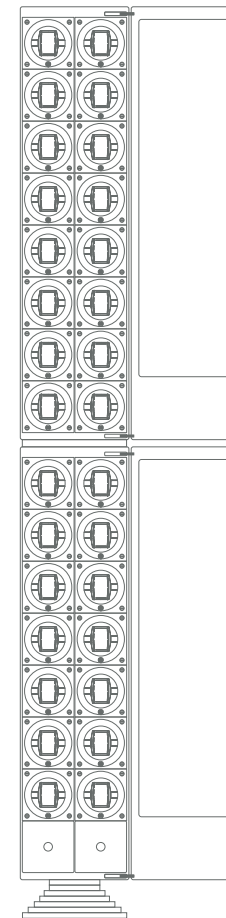



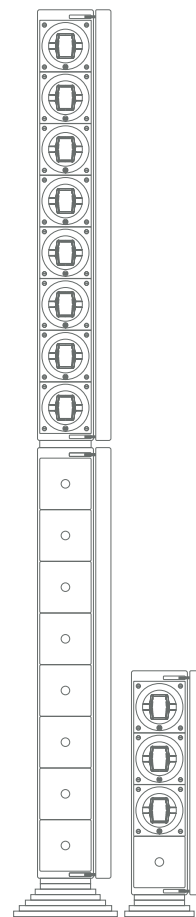

CONFIGURATION

Configurable structure, composed by modules of four and with one or two columns wide. Infinite combinations turning it into a perfect complement for your room.



argia

argia

Argia

The Argia safe is all about light.

Its distinctive glass door, it allows to display the jewellery and watches inside.

It has a LED system that lights up when the door opens and an interior dehumidification system working with a controlled heat emission.

It is available in three sizes, all of them with a flexible composition inside, which configures the interior as desired. The exterior finish is made to order according to the customer's requirements, either in leather, wood or painted (see page 53).



A safe with character

Argia

A combination of beauty, aesthetics, exclusivity, comfort and luxury



SECURITY

The Argia security safe is exclusive and handcrafted. As well as being very comfortable and practical, it has all the necessary features to store and display your values with security, confidence and total calm.

It incorporates an automatic relocking system as additional protection in case of direct attack, and an automatic locking system for the locking bolts, so as not to damage the door in case of accidental closure (when they are open).

It is provided by a key lock in addition to the standard electronic combination lock, and there is also the option of equipping it with a fingerprint scanner.



Argia

MODELS

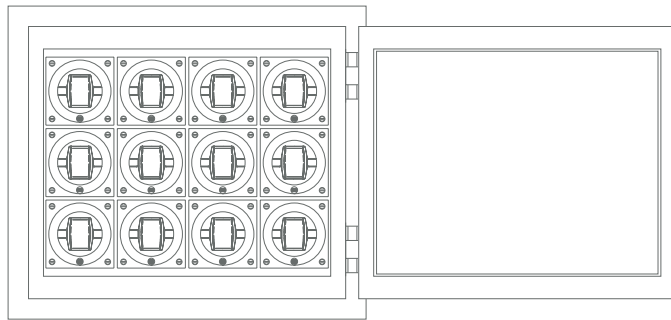

Argia S

12 modules
4 columns and 4 rows

526 x 456 x 340 mm (width, high, depth)

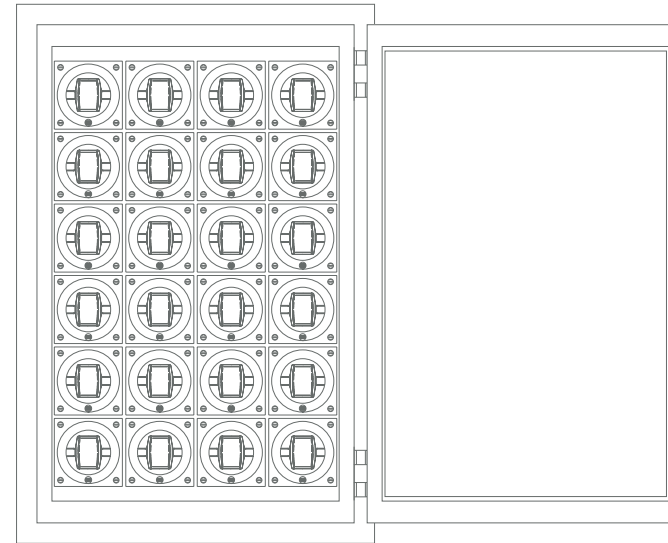

Argia M

24 modules
4 columns and 6 rows

526 x 792 x 340 mm (width, high, depth)

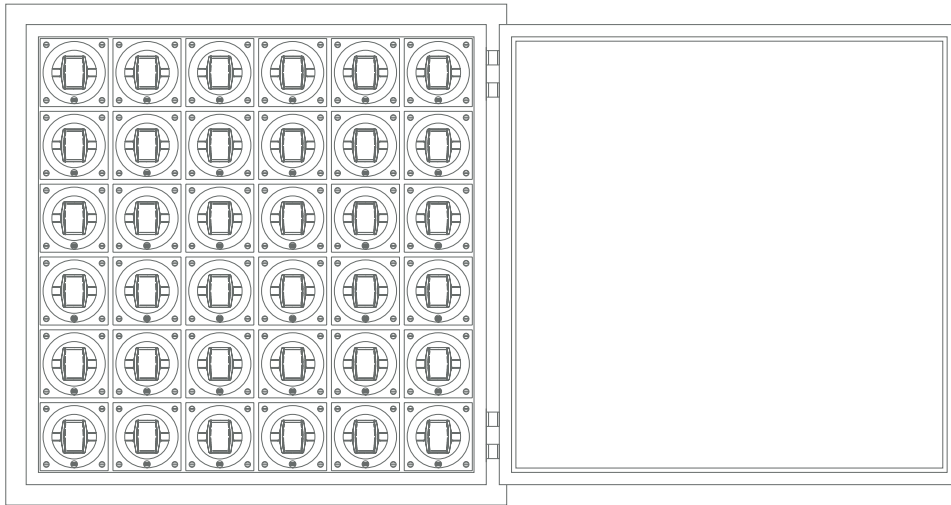

Argia L

36 modules
6 columns and 6 rows

736 x 792 x 340 mm (width, high, depth)





CONFIGURATION

The modular design of Argia series allows the interior to be adapted with multiple possibilities.

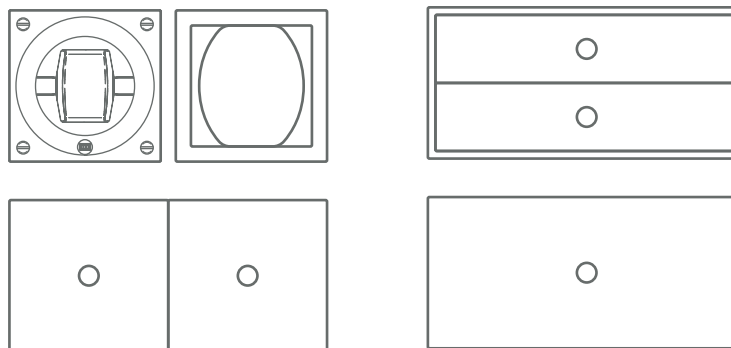



Endless possibilities for the interior of the Argia security safes.



finishes



interiors

interiors

Interior finishes

We create safes so that their use is a unique and incomparable experience for each of our customers.

That's why, for us, the fact that you can choose the interior of your safe is an essential requirement for our entire *Luxury Edition* range.

Safes designed and manufactured for you





INFINITE POSSIBILITIES

The interior of the safes can be configured with different modules depending on the model.

The Lira and Argia ranges start with a 10 x 11 cm cubic unit, in which a fixed display (either for watches or jewellery), a motorised automatic watch winder or a drawer can be placed. The combination of two widths of the base module allows trays for writing, jewellery or watches, or a double drawer (figure A).

For the Zendo range, the freedom is even bigger, adapting the width of the modules according to the model of case and allowing the drawers to be completely removed, for example, or mixing different heights, incorporating glass trays, mirrors, rotors...

In all our models, the interiors of drawers and trays are fully customisable (figure B).

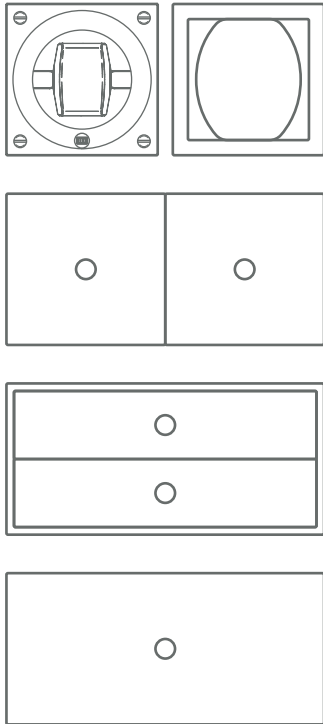

FIGURE A

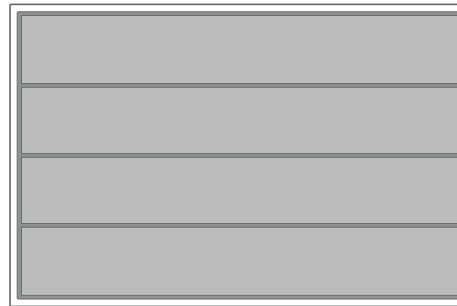
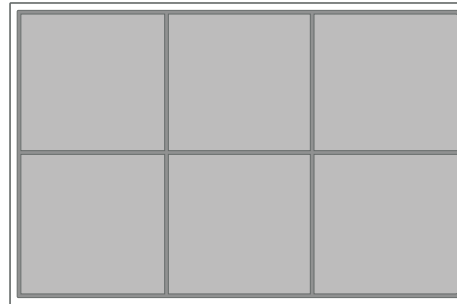
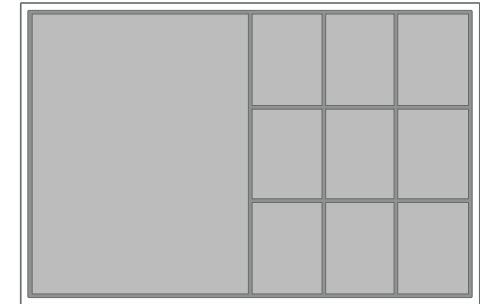

FIGURE B





exteriors

exteriors

Exterior finishes

LACQUER FINISH

We have designed an exclusive range of lacquers and special finishes to turn safes into unique pieces.

Our paint finish is made with liquid paint of synthetic origin applied with a high-precision airbrush. Once applied, the paint is stabilised on the surface of the piece which, when dry, gives it an exceptionally smooth and resistant finish.

The final polishing and waxing of each safe is carried out by hand with extreme care and attention to detail to ensure a luxurious image.



Exterior finishes

COLOUR SELECTION



LM-1.01
METALLIC SILVER



LM-1.02
METALLIC PEARL



LM-1.03
METALLIC GOLD



LM-1.04
METALLIC COOPER



LC-2.01
WARM WHITE



LC-2.02
CREAME

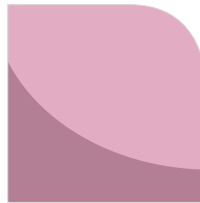

LC-2.03
LOVE PINK



LC-2.04
HOT RED



LC-2.05
DARK WINE



LC-2.06
CHOCOLATE BROWN



LC-2.07
MOSS GREEN



LC-2.08
NAVY BLUE



LC-2.09
DARK GRAY



LC-2.10
MEDIUM GRAY



LC-2.11
LIGHT GRAY



LC-2.12
DEEP BLACK

SPECIAL COATINGS



(COD. COATED)-PL
SILVER

Special varnish to give a luminous detail to the piece.

Ideal to combine with dark and cold colours (greys, blues, blacks).



(COD. COATED)-DR
GOLDEN

Special varnish to give a luminous detail to the piece.

Ideal to combine with clear and warm colours (whites, browns, bordeaux).



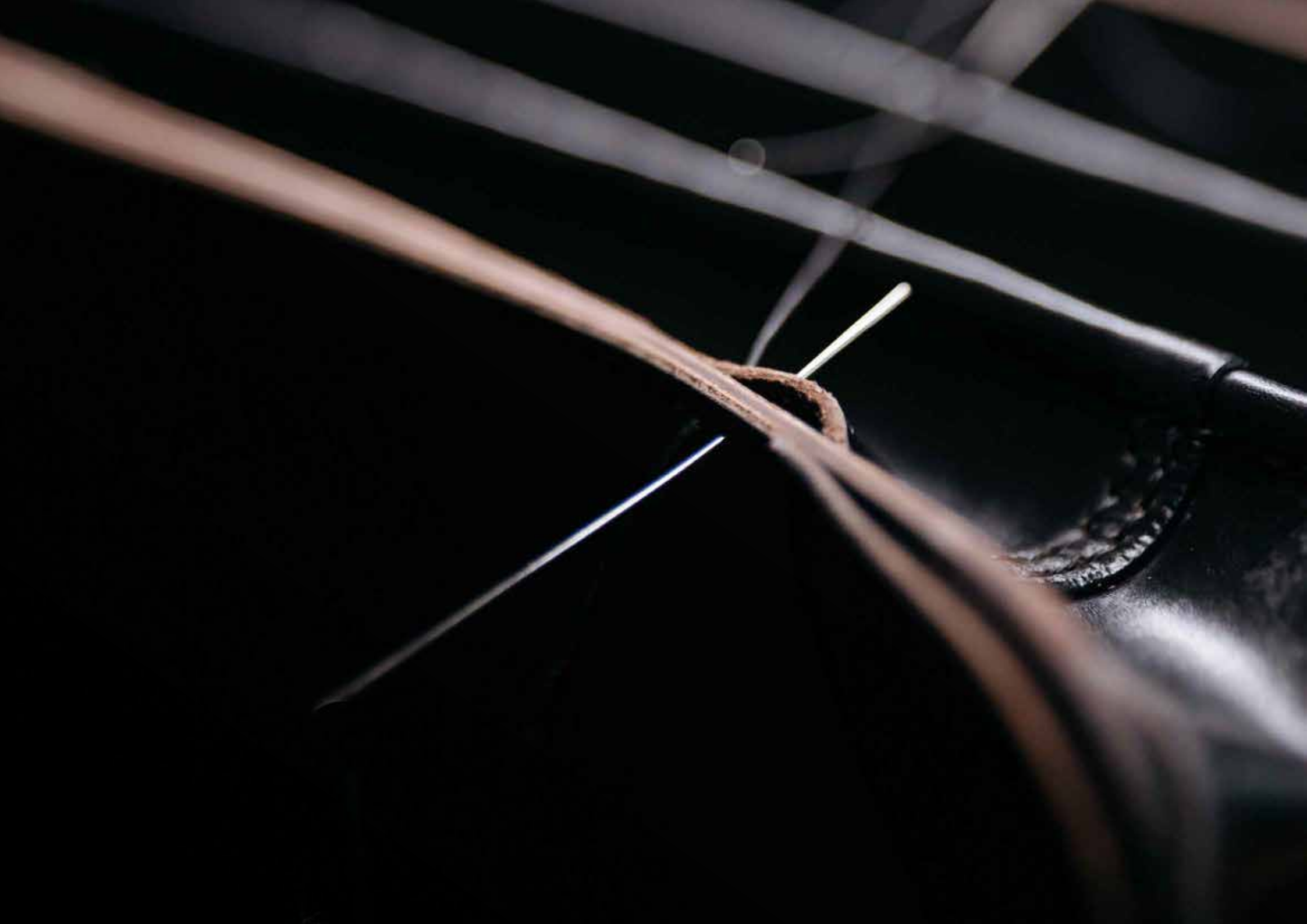



LEATHER FINISH

Leather is very present in watches and fashion accessories (for men and women).

Working with leather is an age-old, meticulous and totally hand-crafted practice that, in addition to giving the piece an exclusive, high-quality finish, gives it an unequalled feel and warmth, which transforms it into a very special piece.

All our products can be leather-lined, with 30 different finishes and their respective combinations between them and with other materials.



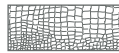

EXOTIC LEATHERS

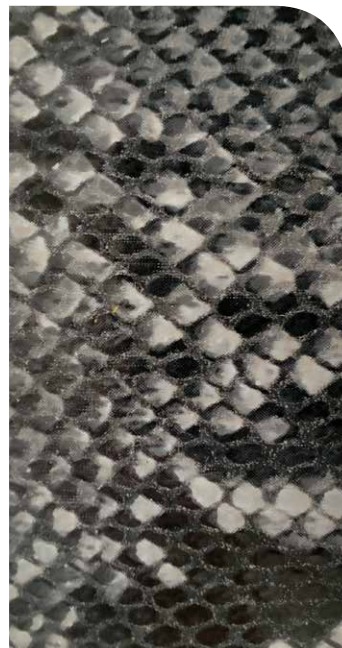

PE-1.01
GREY SNAKE

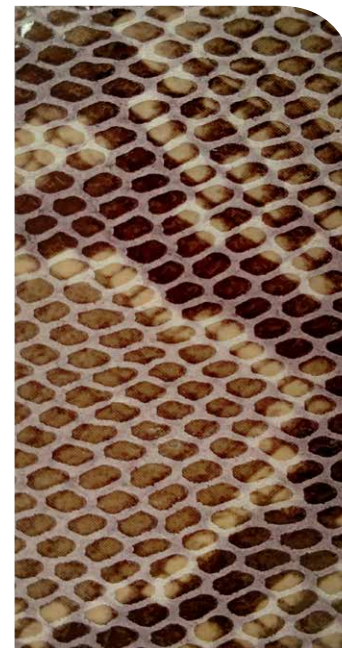

PE-1.02
BROWN SNAKE

Exterior finishes



PE-1.03
PEARL CROCODILE



PE-1.04
SCARLET CROCODILE



PE-1.05
CARAMEL CROCODILE



PE-1.06
BLACK CROCODILE

Exterior finishes

 NATURAL LEATHERS
WITH SOFT TEXTURE

					
					
<hr/> <p>PS-2.01 ELEGANT BLACK</p>	<hr/> <p>PS-2.02 NEUTRAL GREY</p>	<hr/> <p>PS-2.03 FRESH DEEP BLUE</p>	<hr/> <p>PS-2.04 JUNGLE DEEP GREEN</p>	<hr/> <p>PS-2.05 LOVE DEEP RED</p>	<hr/> <p>PS-2.06 ENERGY RED</p>



PS-2.07
CHOCOLATE BROWN



PS-2.08
WALNUT BROWN



PS-2.09
PEANUT BROWN



PS-2.10
LIQUEUR CREAM



PS-2.11
PEARL BEIGE

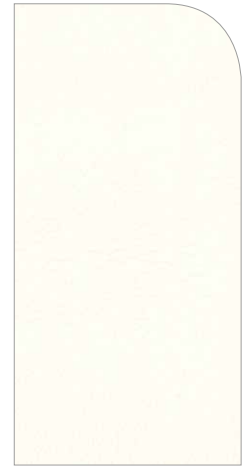

PS-2.12
WARM WHITE

Exterior finishes

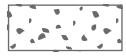

NATURAL LEATHERS
WITH MEDIUM TEXTURE



PM-3.01
GRUNGE BLACK

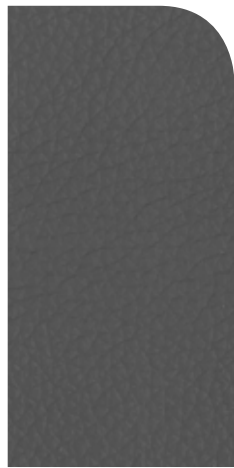

PM-3.02
DEEP GREY



PM-3.03
NAVY BLUE



PM-3.04
MILITAR GREEN



PM-3.05
VIVID ORANGE



PM-3.06
VINE RED



PM-3.07
PASSION RED



PM-3.08
CONTRAST BROWN



PM-3.09
WOOD BROWN



PM-3.10
DUNE SIENNE



PM-3.11
STONE BEIGE



PM-3.12
NATURAL WHITE





WOOD FINISH

Thanks to the tone and shape of the wood grain, this finish brings warmth to the safes and gives them a completely new look, leaving behind the coldness of the steel from which they are made.

The lining process is complex, as every last detail is taken into account to ensure an excellent result.

The application of the wood can be done at exterior and interior of the safes, allowing the combination with other materials.



Exterior finishes

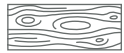

NATURAL LIGHT WOODS



MC-1.01
WHITE OAK



MC-1.02
WHITE ELM



MC-1.03
SAND OAK



MC-1.04
GREY TEAK

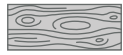

NATURAL MEDIUM WOODS



MM-2.01
NATURAL OAK



MM-2.02
CLASSIC CHERRY-TREE



MM-2.03
VIVID WALNUT



MM-2.04
WILD OAK

Exterior finishes



NATURAL DARK WOODS



MO-3.01
COFFEE STRIPED



MO-3.02
LAVA SPLINTED OAK



MO-3.03
ANTRACITA STRIPED



MO-3.04
BLACK OAK





locks

locks

Locks

There are different locking systems available, which can also be combined with others,

From conventional mechanical key systems or electronic systems (such as code combinations) to sophisticated biometric systems.

All of them are certified according to the current standards and guarantee maximum security.



MECHANICAL AND ELECTRONIC SYSTEMS

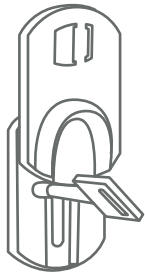

KEY LOCK

The most extended and reliable system.

Available with different types of keys (interchangeable, single blade, double blade...), according to EN 1300 standard.

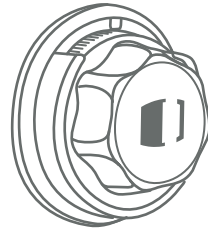

COMBINATION DISC MECHANICS

Along with the key, it is the mechanical system by excellence.

It can have 3 or 4 discs, which increases the length of the combination, also increasing the degree of security.

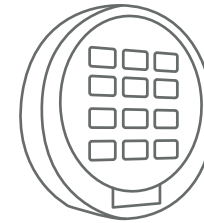

ELECTRONIC COMBINATION

A reliable and convenient system, which works with a numerical pin.

The code is unique and can be reset if necessary. Various models and finishes are available.

BIOMETRIC SYSTEMS



Biometric systems allow opening by scanning a biological element. These are usually eye iris, fingerprint, facial or palm venous system scanners.

Such advanced electronic systems offer additional protection as they are a non-transferable methods of access (although they allow multiple user registration).

In addition, many of these systems minimise physical contact and also are very useful, fast and comfortable.

The most advanced and secure technology for your safe

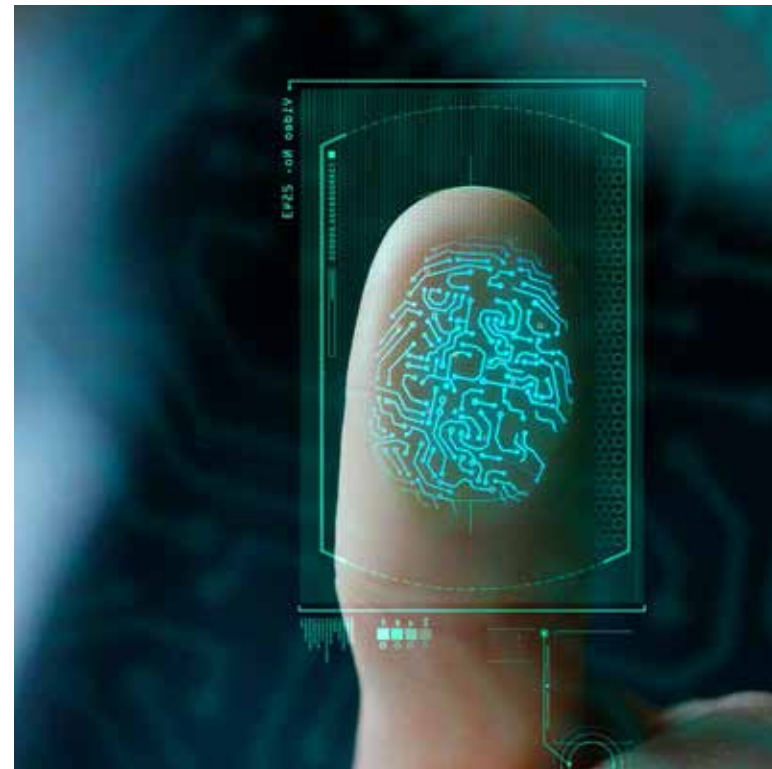

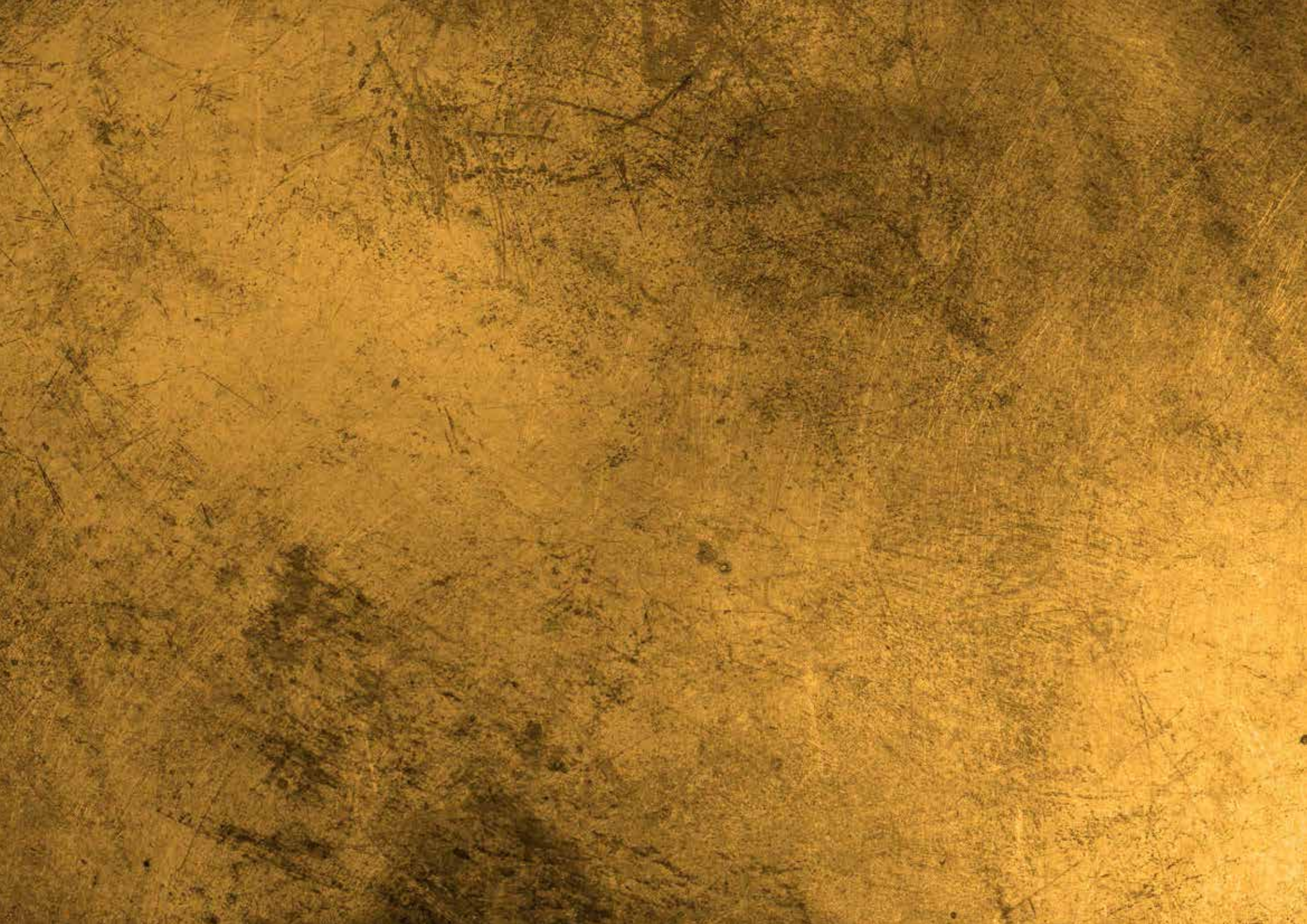

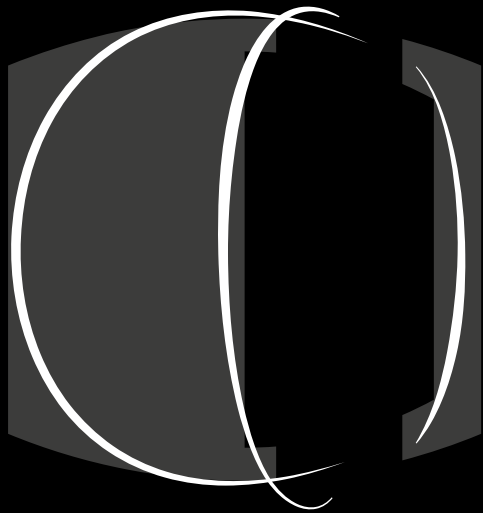

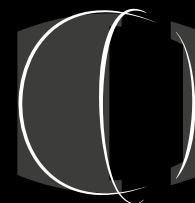

FERRIMAX
luxury edition

Gran via, 623, Barcelona (SPAIN)
www.ferrimax.com/luxury · luxury@ferrimax.com
[@ferrimax_luxury](https://www.instagram.com/ferrimax_luxury)