

**3M** Science.  
Applied to Life.™



# Personal Safety Division

Product Catalogue 2022

#3MScienceOfSafety

## Introduction

3M™ is a global science-based innovation company, developing products that improve people's daily lives in a multitude of ways.

3M Science can be found in your home, in your office, at the hospital, at the dentist, in your phone, in your PC, in your car. You'll find it on roads, trains and airplanes, and it's helping to connect you with your energy and with the outside world. Improving your life in hundreds of ways every day.

We do this through a unique culture of innovation. One where people are given the freedom to create, the responsibility to deliver and the opportunity to connect ideas and technologies in unexpected ways.

From concept to creation we manufacture our products to exacting quality standards, whilst working hard to look after our people, our communities and our planet.

Founded in 1902, we have a proud history as one of the world's most innovative and ethical companies.

From the hidden science we all take for granted to the tangible products we use every day, 3M solutions can be found in every corner of life.

**3M Science. Applied to life.**

**PELTOR™**



**PROTECTA**

**SCOTT™**  
Fire & Safety

**E·A·R™**  
Hearing Protection

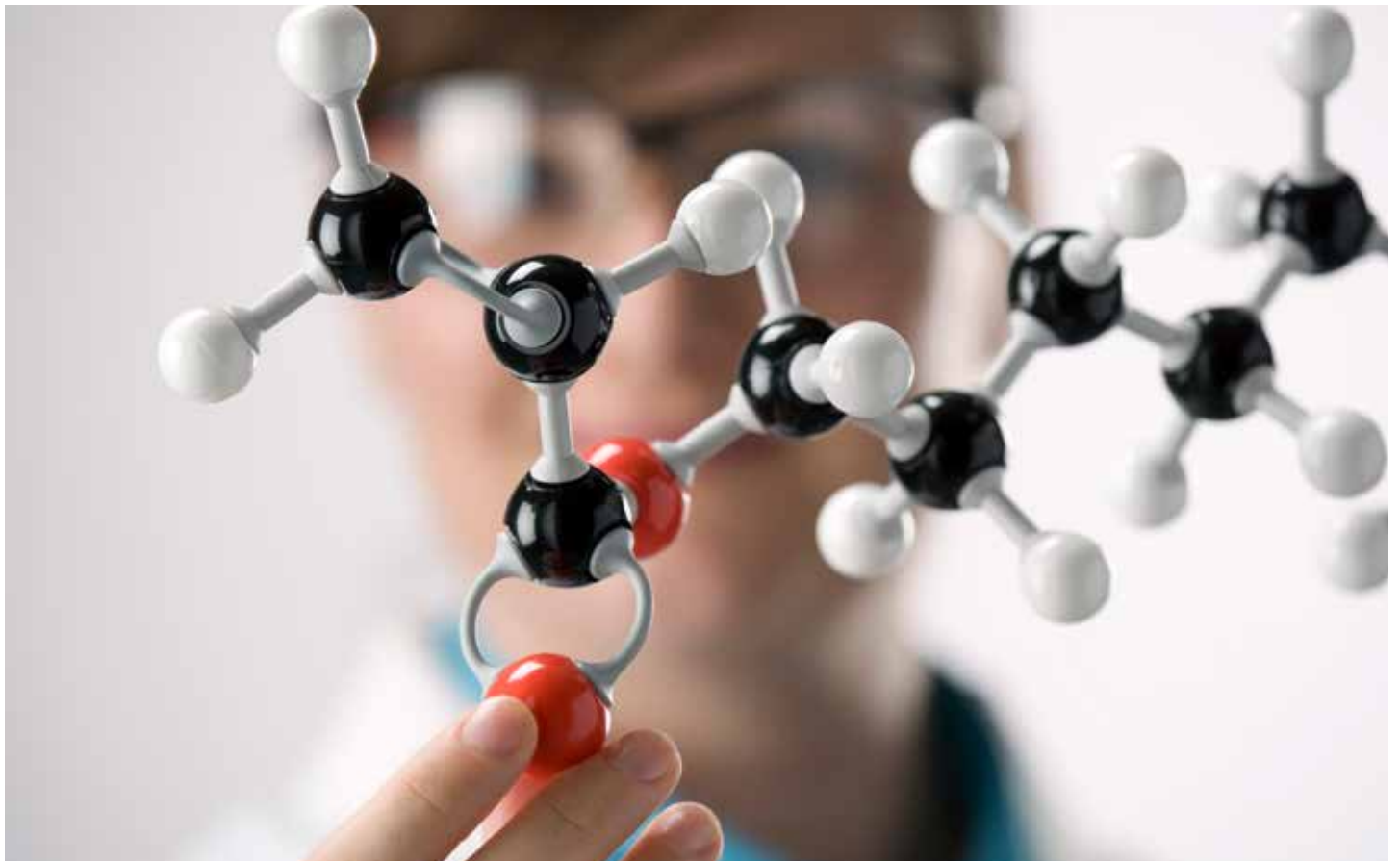

# Contents

<b>About 3M</b>	<b>04-08</b>	<b>Communications</b>	<b>101-109</b>
Personal Safety Division	05	The safe way to be heard, and get things done	102
Science of Safety	06	Functions	103
Service	08	3M™ Peltor™ Smart Hearing Solutions	104
<b>Respiratory Protection</b>	<b>09-10</b>	<b>E-A-Rfit™ Validation</b>	<b>110-112</b>
Types of respiratory protection equipment (RPE) from 3M	10	3M™ E-A-Rfit™ Dual-Ear validation system	111
<b>Disposable Respirators</b>	<b>11-24</b>	<b>Head Protection</b>	<b>112-123</b>
Airborne hazards	12	About the range	114
Our technology	13	<b>Face Protection</b>	<b>124-129</b>
Cool flow valve	14	<b>Eye Protection</b>	<b>130-143</b>
The importance of comfort	15	About the range	131
Selecting the right product	16	Human eye	132
The importance of fit	21	Protection all the way	133
Selection flowchart	24	How to pick the right tinted safety glasses for your job	134
<b>Reusable Respirators</b>	<b>25-48</b>	Protective eyewear	135
How an organic vapour respirator cartridge works	27	Lens Markings	136
How do particle filters work	28	Features selection guide	137
A respiratory solution for every task	29	<b>Body Protection</b>	<b>144-151</b>
Guide to identify and assess hazards	30	Materials	145
Hazard identification and protection recommendations	31	Product selector diagram	150
Filter selection guide	31	Product selector table	151
Select the right respirator and cartridge/filter	32	<b>Fall Protection</b>	<b>152-218</b>
Select the right respirator	34	Safety as basic as the ABCs!	154
The importance of monitoring 3M™ gas diffusion monitors	47	<b>Anchorage</b>	<b>156-159</b>
<b>Fit Testing</b>	<b>49-51</b>	<b>Body Harnesses</b>	<b>160-177</b>
Why is fit testing so important?	50	<b>Connectors</b>	<b>178-192</b>
<b>Powered Air Purifying Respirators</b>	<b>52-68</b>	<b>Descent &amp; Rescue</b>	<b>193-205</b>
Experience maximum flexibility as you move from one job to the next	54	<b>Speciality Systems</b>	<b>206-208</b>
Which air system should I choose?	55	3M™ DBI-SALA® FlexiGuard™ Solutions	206
Modular respirator systems	57	3M™ DBI-SALA® Engineered Systems	208
Facepiece selection guide	67	<b>Fall Protection Accessories</b>	<b>209</b>
<b>Airline &amp; Escape</b>	<b>69-74</b>	<b>Fall Protection for Tools</b>	<b>210-215</b>
<b>Self Contained Breathing Apparatus</b>	<b>75-84</b>	<b>Fall Protection Services</b>	<b>216-218</b>
<b>Hearing Protection</b>	<b>85-89</b>	<b>Thermal Imaging</b>	<b>219-221</b>
The solution, protection and validation	87	Ultimate combination of situational awareness	220
Understanding sound level conversion (SLC80)	87	<b>Spare Parts</b>	<b>222-235</b>
When it comes to protecting workers' hearing there is no one-size fits all solution	88		
What types of sounds require hearing protection?	89		
It starts with PAR	90		
<b>Earplugs</b>	<b>90-97</b>		
<b>Earmuffs</b>	<b>98-100</b>		



# About 3M

3M provides safety solutions that improve comfort while helping employers increase compliance, with personal protective equipment for everything from your eyes and head to hearing, respiratory system, fall protection and fall protection equipment.

# Personal Safety Division

3M helps keep everyone safer in a changing world. Across diverse industries and applications our technology, expertise and energy drive innovative solutions to help you control your environment so you can focus on the job at hand.

The Personal Safety Division provide safety solutions that improve comfort while helping employers increase compliance, with personal protective equipment for everything from your eyes and head to hearing and respiratory system.

On any given shift, workers may potentially put themselves in harm's way. The risks are endless, ranging from head and eye injuries, hearing and respiratory protection hazards, and falls from height. Our personal safety products deliver high standards of protection for workers in the deepest of mines through to the top of the tallest towers.

3M is passionate about protecting the health and safety of workers in all types of industries and workforce environments enabling them to return home to their families safely at the end of each work day. With decades of research and technological advances behind us, 3M Personal Safety Division delivers innovative Personal Protective Equipment (PPE) and integrated safety solutions designed to help keep workers safe, comfortable and productive on the job.

Our Personal Safety Portfolio delivers comfortable, well-designed personal protective equipment that offers workers the most effective protection available and includes:

- Respiratory Protection
- Hearing Protection
- Communication Solutions
- Fall Protection
- Eye Protection
- Head & Face Protection
- Welding Protection
- Body Protection



# Science of Safety

Protecting people. Improving lives. Enhancing productivity.

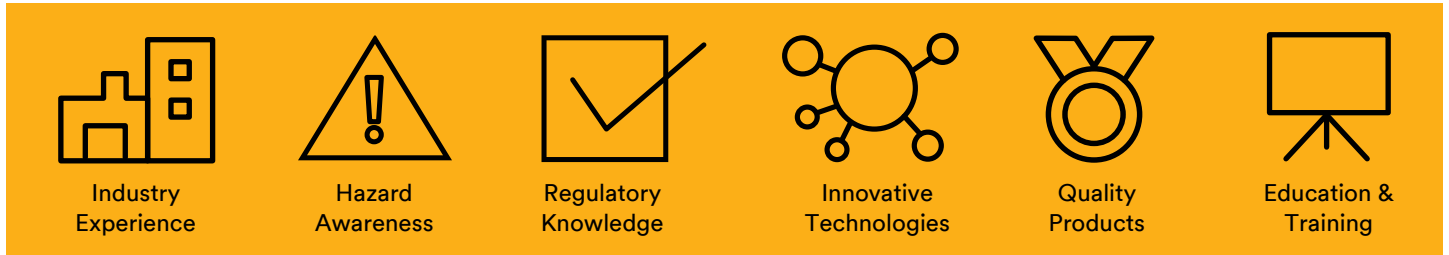

At 3M, we innovate with purpose and use science every day to shape the future of personal protection and the wellbeing of workers. Our commitment to safety drives us to continue to innovate across technologies, disciplines, and industries to help keep workers safe and protected to deliver our mission of: “Helping workers return home safely and live healthier lives”.

3M Science of Safety is about the way safety managers and business owners can work together with 3M to solve complex health and safety challenges every day. The Science of Safety

formulates how we approach worker health and safety from a proactive, customer-focused perspective and how we are equipped to respond with a comprehensive offering of solutions driven by customer insights.

Using this approach, we continue to find unexpected ways to apply our broad range of technology platforms to help solve complex worker health and safety challenges.

**3M's Science of Safety approach can support you with guidance on:**

<h3>Selection</h3>  <p><b>After identifying and assessing the hazards within the working environment,</b> narrowing down the most suitable product options for the situation enables the selection process to begin. Selecting comfortable and appropriate PPE enhances user acceptance and ongoing protection within the workplace.</p>	<h3>Training</h3>  <p><b>Training provides the user confidence in the knowledge</b> that they know how to use their chosen and required PPE. Whether that be understanding the need for protection, when to change filters on a respirator or what are the maintenance procedures for the equipment. Training empowers users to consistently wear PPE.</p>	<h3>Fit Validation</h3>  <p><b>Every wearer is different. In order to be fully protected, it is essential that PPE fits correctly.</b> We provide fit testing for respirators (and fit testing guidelines online) as well as E-A-Rfit Validation testing for earplugs and earmuffs. Fit Validation is a short simple process that provides timely information around the quality of product fit whilst indicating what type of product is suitable for the individual and situation. In order to get the best protection, it is crucial that they know how to correctly fit and wear their personal protective equipment.</p>
---	---	--

3M delivers consistent quality around the world helping you select the correct PPE for your workers, helping to ensure your workers are educated on the correct use of PPE and raising awareness of how important fit & comfort are to the health and wellbeing of your workforce.



# 3M™ SafeTea Toolbox

Do you struggle to talk to your workforce about health and safety?

3M™ has created a free 10 module 3M™ SafeTea Toolbox Kit. It provides you with the toolkit and platform you need to engage your workforce in a discussion about health, safety and long latency occupational diseases.

Download your free kit, on our 3M™ Worker Health & Safety website,  
[https://engage.3m.com/SafeTeaToolbox\\_NZ](https://engage.3m.com/SafeTeaToolbox_NZ)

**Start the conversation.**

# Service

We believe that with a quality product, it is important that the customer also receives quality services. Not only do we provide different varieties of training and education, but we also have many other services available to our customers.

### 3M™ Respiratory Fit Testing System

3M Respiratory Protection offers a wide range of disposable and reusable respirators, as well as Powered and Supplied Air Respiratory Systems. However, even high quality products need a secure fit in order to protect the wearer. One model of respirator may not fit everyone.

When choosing a close fitting respirator, users should be fit tested in accordance with national requirements. For information on fit testing procedures, contact your safety officer or 3M.

Even after a user has had a fit test, a fit check should be carried out before each use.

### 3M™ E-A-Rfit Dual-Ear Validation System

As the leader in hearing protection, 3M offers a complete solution, with ear plug and earmuff testing capabilities plus a user-friendly interface. The 3M™ E-A-Rfit Dual-Ear Validation System is the fast and easy way to find your employees' Personal Attenuation Rating (PAR), because we know how important it is to make your hearing conservation program fit seamlessly into your operation.

Get results you can trust. The 3M™ E-A-Rfit Dual-Ear Validation System measures the effectiveness of the earplug or earmuff in the employee's ear providing accurate, quantitative results. Because you can simultaneously test both ears, you have more time to focus on education including the importance of fit and protection.

### Self Contained Breathing Apparatus

Our factory trained and certified 3M Scott Service team specialise in testing, maintaining and repairing Scott's full range of products and systems. Including;

- Self Contained Breathing Apparatus
- Supplied Air Equipment
- Powered Air Respiratory Equipment
- Thermal Imaging Equipment

So, whether it's responding to an urgent service request, providing scheduled annual servicing or simply providing user technical support, we put customers first and serve them as if their lives depended on it. Because sometimes, they do.



**3M** Science.  
Applied to Life.™



# Respiratory Protection

3M offers you a wide range of disposable, reusable, powered and supplied air respirators for protection against gases, vapours and particulates. Allowing you to choose the level and type of protection, comfort, style and maintenance requirements you need to work safely, comfortably and effectively.

**#3MScienceOfSafety**

# Types of respiratory protection equipment (RPE) from 3M.

There are three main types of RPE available from 3M:



### Disposable Respirators

- Ideal for most industries and applications where wearers require particulate protection e.g. dusts and mists
- A choice of cup-shape or flat-fold, valved or unvalved and also the option to protect against ozone and nuisance\* levels of organic vapours and acid gases
- Lightweight and maintenance free
- Comfortable, convenient and easy to use



### Reusable Half and Full Facepiece Respirators

- Offer protection against particulates, gases and vapours and combinations of the two
- These respirators have integrated or replaceable filters and parts. They may be cleaned, stored and reused provided they are in good condition
- Full Facepiece respirators also offer integrated eye and face protection
- Many models are fully maintainable



### Powered Air & Supplied Air Systems

- Offer protection against dusts, mists, fumes, gases, vapours and combination hazards e.g. paint spray
- Can offer integrated eye, face, head, neck and hearing protection in one system avoiding incompatibility issues between items of PPE
- Modular system allows you to mix and match parts as your environment or application changes, giving you the ultimate in flexibility and ease of use
- No increase in breathing resistance means more comfortable and longer wear time
- Usable by a wide range of users regardless of facial characteristics; shape, size etc.

\* Nuisance levels are those levels below the WorkSafe New Zealand Exposure Standards.



# Disposable Respirators

Comfortably breathing clean, safe air is important for workers' health and workplace morale. With this in mind we have designed a range of 3M™ Disposable Respirators using science to increase comfort, breathability and protection. In combination with ergonomic design, a wide range of technologies including the 3M™ Cool Flow™ Comfort Valve help to deliver comfortable protection with easier breathing and reduced heat build-up.

# Airborne hazards.

Finding the right protection...



3M™ Aura™ 9322A+  
Particulate Respirator



3M™ 8322  
Particulate Respirator



3M™ Aura™ 9312A+  
Particulate Respirator



3M™ 8312  
Particulate Respirator



3M™ 9422+  
Particulate Respirator



3M™ 8710  
Particulate Respirator



3M™ 8822  
Particulate Respirator



3M™ 8514  
Particulate Respirator



### Brick Dust

Brick dust and ash contains very fine particles of silica which can be breathed deep into the lungs and scar the delicate tissue (silicosis); exposure may also increase the risk of lung cancer.



### Cement Dust

Some cement processes can also release very small particles of silica which can be breathed deep into the lungs and scar the delicate tissue (silicosis); exposure may also increase the risk of lung cancer.



### Wood Dust

Exposure can cause occupational asthma in some individuals as inhalation of wood dust particles may initiate an allergic reaction causing them to become more sensitive in the future. Dusts from hardwoods may also cause cancers of the nose.



### Lead

Dust and fumes inhaled from industrial processes involving lead or lead compounds may be absorbed and circulate in your blood. Lead can be excreted but it can also be stored by the body. If the amount of lead in your body is too high, it can cause symptoms such as headaches and nausea. If uncontrolled, long term exposure can damage vital organs.



### Silica

Very small particles of silica dust, called respirable crystalline silica, can be breathed in and may reach deep into the lungs where it can scar the delicate tissue (silicosis) resulting in difficulties breathing. Long-term exposure to crystalline silica may also increase the risk of lung cancer.



### Flour Dust

Inhalation of dust particles from flour can cause bronchitis and irritation to the nose and airways. In some people, exposure may cause occupational asthma, wheezing or serious breathing difficulties.



### Welding

Inhalation of some metal oxides found in welding fumes can lead to metal fume fever - the symptoms are short term but include coughing, headaches and fever. Exposure to certain nickel and chromium compounds found in some welding fumes may increase the risk of lung cancer.

# Our technology.



In 1969 3M invented the disposable respirator. We were also involved in the development, trial and authentication of qualitative fit testing protocols for respirators.

Since then, we have developed numerous proprietary technologies that have been incorporated throughout our comprehensive range of disposable respirators.

Workers need respirators that fit well, are comfortable and provide the best protection. Employers want quality products from a supplier they can trust. Our wide range of respirators helps to deliver easier breathing and comfortable protection against particles and certain gases and vapours. All our disposable respirators are compatible with eyewear and hearing protection products from 3M.

All 3M respirators meet the performance requirements of Australian/New Zealand Standard AS/NZS 1716:2012 'Respiratory protective devices'.

## Advantages of 3M™ Disposable Respirators



### 3M™ Cool Flow Valve

An efficient exhalation valve minimises heat and moisture build up, particularly in hot and humid work conditions.



### 3M™ High Performance Filter Media

High Performance Filter Media combines the benefits of traditional mechanical filtration with advanced technology filtration to capture particles.



### 3M™ Foldable Three-Panel Design

This design offers improved comfort, fit and communication – plus the convenience of a foldable respirator. (9300A+ series)

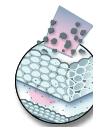

### 3M™ Clog-Resistant Welding Respirators

Particles are trapped throughout the lofty outer layer and then by the inner filter. This prolongs respirator life while maintaining ease of breathing.

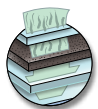

### Activated Carbon

Layers of carbon in 3M™ Welding and 3M™ Specialty Respirators are designed to offer relief from the irritation of low levels of specific gases and vapours.

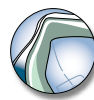

### Importance of Fit

3M provides a variety of respirators for customers to select one that fits best on their own face. Fit testing is used to confirm adequate fit and level of protection in the work place.

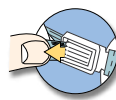

### Adjustment Buckle Straps

Simply pull on the 3M™ Universal Buckle to achieve the optimal comfort and security.



### Confidence in Numbers

3M has a rich 100-plus-year history of research and innovation, over 40 in respiratory protection alone, and a passion for designing safe, comfortable respirators. The first Saccharin and Bitrex™ qualitative fit test methods were invented by 3M.

# Cool flow valve.

## Cool comfort starts with cool breathing

The proprietary 3M™ Cool Flow™ valve is designed to release your hot, humid exhaled breath quickly, helping to prevent an unpleasant build up of heat inside the facepiece - a significant cause of discomfort to respirator wearers.

This makes Cool Flow valved respirators ideal for long periods of wear, especially where conditions are hot, humid or physically demanding.

### Expel heat as you exhale it

#### Unique proprietary design

- Seals during inhalation
- Easily opens during exhalation

#### Aerodynamically designed valve cover

- Directs airflow away from your eyes and face to help reduce eyewear fogging

#### In combination with 3M proprietary filter media

- The Cool Flow valve helps minimise breathing effort required by respirator wearer

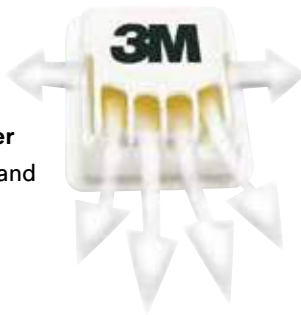

### Inside the respirator: Stay cooler with 3M™ Cool Flow™ Valve

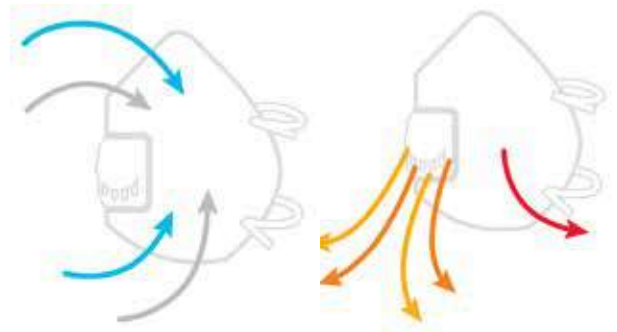

# The importance of comfort.

To make sure that the respirator protects you, it must be worn during periods of exposure. Make sure that you choose a respirator that you can wear comfortably for your entire shift.



### Face and head comfort

The respirator's edge should be flexible and the shape and size should cover the nose, mouth and chin without causing excessive pressure. A headband material which provides a good, even tension across the head can ensure a comfortable, secure fit for a range of head sizes.



### Coolness

An efficient exhalation valve minimises heat build up, particularly in hot and humid work conditions.



### Breathing ease

An efficient exhalation valve and high-efficiency, low breathing resistance filter material will help you to breathe comfortably.



### Skin comfort

Skin comfort will be affected by the smoothness and softness of the inner material in contact with the skin - especially over a long period of time. A soft inner face seal and sweat absorbent nose foam will provide greater comfort. Rough or hard materials, coupled with a high temperature inside the respirator may be itchy and unpleasant.



### Lightweight

Take advantage of technological innovation and choose a lightweight respirator for optimal comfort.



### Compatibility with other PPE

Make sure that the respirator you select fits well with the other PPE required for your work, such as eyewear and hearing protection to ensure maximum comfort.

# Selecting the right product.

Selecting and specifying the appropriate respiratory protective equipment can seem daunting with so many factors to consider. Use our simple four step selection system to ensure the respirator you choose offers the correct levels of protection and comfort required.

## 1. Identify the hazards

Industry	Application	Hazard	Filter Rating
General	Sanding, cutting, drilling	Rust, metal particles, filler, concrete, stone, wood	P1
	Sanding, cutting, drilling	Crystalline silica, cement, wood, steel, paints, varnish, anti-rust coating, steel, stainless steel, anti-fouling varnish	P1 P2
	Low temperature oil spraying, lubricating	Mineral oil, agricultural mineral oil, horticultural mineral oil, oil foam spray, metal working fluid	
Construction	Sanding, cutting, drilling	Crystalline silica	P1
	Plastering, tunnelling, sawing, earthmoving, carpentry	Dust, sawdust	
	Painting, spraying, varnishing, coating, mixing	Water based paints, roller/brush applied spray coatings, adhesives, cleaning solvents (nuisance* levels)	GP1
Metal Fabrication	Oxy-acetylene cutting, metal pouring, soldering, smelting, welding, work with glass and mineral fibres	Metal fume	P2
Welding	MIG, TIG, mild steel, zinc (autogen, MIG/MIK) Stainless steel (electrodes), soldering	Welding fume and ozone	P2
Agricultural & Forestry	Sawing, cropping, cotton ginning, feeding livestock, allergies	Wood dust, grain dust, Cotton dust, animal dander	P1
	Handling infected animals, cleaning animal sheds, composting, waste sorting	Bioaerosols, bacteria, fungus, animal dander	P2
	Spraying pesticide, herbicide, fungicide: *low vapour pressure organic compounds	Paint spray, mist, dust, pesticide (water based)	GP1
Mining & Quarrying	Drilling, blasting, plant operators	Dust	P1
	Drilling, blasting, plant operations	Diesel exhaust/smoke	P2
Healthcare	Infection control	Infectious aerosols, TB, other bacteria/virus, allergies, pollen, mould/fungus	P2 N95
Aluminium Smelting & Cleaning	Chlorine based cleaning, smelting	Acid gases	P2
	Chlorine based cleaners	Acid gases	P1
Agricultural & Forestry	Pesticide spraying, solvent cleaning, welding	Organic vapour	GP2
	Pesticide spraying, solvent cleaning	Organic vapour	GP1
Food & Beverage, Manufacturing, Pharmaceutical	Food handling, fruit & vegetable processing, manufacturing pharmaceutical - shaping, tablet formation, cleaning & maintenance	Dusts, mists and fumes generated during handling of cereal & non-cereal flours, nuts, additives, spices, condiments, coffee, sugar, egg and fish proteins, confectionery, animal & bird feed	P1
	Shaping/tablet formation, medicinal and pharmaceutical product manufacturing, cleaning & maintenance	Pharmaceuticals during the production of prescription drugs	

\* Nuisance levels are those levels below the WorkSafe New Zealand Exposure Standards.



# Disposable Respirators

## 2. Assess the risk

- P1** is the rating given to a respirator which meets AS/NZS1716:2012 for filtering mechanically generated particles, e.g., particles formed by crushing, grinding, drilling, sanding and cutting.
- P2** is the rating given to a respirator that meets AS/NZS1716:2012 for filtering mechanically and thermally generated particles, e.g., those from welding fume. Respirators with a P2 rating are also recommended for use in certain applications against some bioaerosols such as H1N1 and H5N1 Influenza. *N95 is a particulate respirator rating per the US National Institute for Occupational Safety and Health (NIOSH) 42 CFR 84.*
- Type 'G' class rating is suitable for low vapour pressure (below 1.3Pa @ 25°C) organic compounds e.g. many agricultural chemicals like herbicide and pesticide.

## 3. Select the right respirator

### Choose a valved/ unvalved respirator

Once you have selected the protection factor you require, you can then consider whether you need a cup-shaped respirator, or a foldable respirator and whether it is valved or not.

#### Benefits of a Valved Respirator





- Reduces exhalation effort
- Cooler to wear
- Stays comfortable for longer
- Less likely to mist up eyewear

#### Benefits of a Unvalved Respirator

- Lower unit cost
- Reduces potential for wearer contamination of their environment

### Choose a style

You can choose from: Comfort, Classic and Basic Series. Specialty respirators that provide comfortable protection against particles and certain nuisance\* level gases and vapours are also part of our range as are lightweight and effective welding respirators. This wide selection enables you to select the respirator to suit your environment.

			
<b>3M™ Comfort Series</b> <ul style="list-style-type: none"><li>• Exceptional comfort</li><li>• Excellent compatibility with eyewear</li><li>• Unique designs</li></ul>	<b>3M™ Classic Series</b> <ul style="list-style-type: none"><li>• Traditional cup shape</li><li>• Lightweight, comfortable and effective</li><li>• Durable collapse resistant shell</li></ul>	<b>3M™ Welding &amp; Specialty Respirators</b> <ul style="list-style-type: none"><li>• Activated carbon layer</li><li>• Comfort with technology</li><li>• High quality performance</li></ul>	<b>3M™ Basic Series</b> <ul style="list-style-type: none"><li>• Reliable and convenient</li><li>• Lightweight and economical</li><li>• Protection you can afford</li></ul>

## 4. Fit Test

**A respirator cannot protect you fully if it does not fit your face.**

Best practice for any Personal Protective Equipment is to ensure the right fit. Proper fitting of a respirator requires the application of an accepted method of fit testing. It is recommended that wearers be fit tested in accordance with Standards Australia/New Zealand's document AS/NZS 1715:2009.

### Training Offered by 3M

Correct use and appropriate maintenance of personal protective equipment (PPE) from 3M makes a major contribution towards ensuring that it provides effective protection. Our experienced sales and technical teams will help you make the most of your products. In compact training modules, they will show you and your employees how to recognize potential hazards, suggest what measures to take and help explain how to choose the appropriate protective equipment for each particular situation.

\* Nuisance levels are those levels below the WorkSafe New Zealand Exposure Standards.

# Comfort Series 9300A+ Aura™ Particulate Respirators

The 3M™ Aura™ Disposable Respirators 9300+ are the result of 3M's continuous drive to improve comfort. They are packed with ground-breaking ideas, technologies and materials and have also retained many of the features that helped make the original 9300 series hugely popular. Features include low breathing resistance filter technology for easier breathing throughout your shift, an embossed top panel to reduce fogging of eyewear, a sculpted edge for improved compatibility with eyewear and a chin tab to improve ease of fitting.

### Features and Benefits:

#### Low breathing resistance

- Combines the benefits of 3M's electret particulate filter material with advanced low breathing resistance filter technology
- Gives effective filter performance whilst lowering resistance to breathing
- Improved breathing ease and comfort

#### 3M™ Cool Flow™ valve

- Effectively removes heat build up
- Provides a cooler and more comfortable wear
- Removes exhaled air and minimises the risk of fogging eyewear

#### Convenience

- Flat-folded: easy to store when not in use
- Hygienic individual packaging helps protect the respirator from contamination before use
- Innovative chin tab improves ease of donning and adjustment to help achieve a comfortable fit

#### Clear vision

- Embossed top panel helps reduce fogging of eyewear

#### Sculpted nose panel

- Adjustable noseclip helps provide a custom secure seal
- Curved low profile design conforms well to nose and eye contours, allowing more room for eyewear
- Helps provide a good field of vision
- Improves compatibility with eyewear

#### Face and head comfort

- Ingenious 3-panel design fits a wide range of face shapes and sizes
- Accommodates your facial movements
- Collapse resistant; ideal for work in hot, humid environments
- Stays securely in place, helping to provide a good, comfortable seal
- Large water/sweat absorbent nose foam material is soft on the skin
- Smooth inner cover web helps to create a comfortable environment for the face



9322A+



9320A+



9312A+



9310A+

3M Order Code	Model #	Description
XA010017854	9322A+	3M™ Aura™ Particulate Respirator, P2
XA010017847	9320A+	3M™ Aura™ Particulate Respirator, P2
XA010017870	9312A+	3M™ Aura™ Particulate Respirator, P1
XA010017839	9310A+	3M™ Aura™ Particulate Respirator, P1
DE272955704	9322+	3M™ Aura™ Particulate Respirator, P2, Small Pack

# Disposable Respirators

## Comfort Series 8300 Series Particulate Respirators

The 8300 Series is designed with your comfort in mind. The super soft, cushioned lining provides instant yet lasting comfort; whilst the robust design makes these respirators tough and durable.

It also features an M shaped nose clip to make it easier to fit and be more comfortable around your nose.



8322



8320



8312



8310

3M Order Code	Model #	Description
70071623162	8322	3M™ Cupped Particulate Respirator, P2, valved
70071623147	8320	3M™ Cupped Particulate Respirator, P2
70071623154	8312	3M™ Cupped Particulate Respirator, P1, valved
70071623139	8310	3M™ Cupped Particulate Respirator, P1

## Classic Series 8000 Series Particulate Respirators

The cupped shape, twin strap design, nose foam and nose clip help to provide comfort and fit over a range of face sizes. The 3M 8710 respirator was the first disposable respirator to be certified in AS/NZS 1716. Still widely used today, this respirator is trusted by millions of workers all over the world.



8822



8210



8110S



8812



8710

3M Order Code	Model #	Description
WX700900359	8822	3M™ Cupped Particulate Respirator, P2, valved
WX700900011	8210	3M™ Cupped Particulate Respirator, P2
XA010000512	8110S	3M™ Cupped Particulate Respirator, P2 - small size
WX700900243	8812	3M™ Cupped Particulate Respirator, P1, valved
WX700900029	8710	3M™ Cupped Particulate Respirator, P1

## Comfort Series 9422+ Aura™ Particulate Respirators

3M™ Aura™ Disposable Respirators 9422+ are specifically designed for the food industry, coloured bright blue for easy identification and constructed without staples or small detachable parts.



3M Order Code	Model #	Description
GT500079519	9422+	3M™ Aura™ Flat Fold Particulate Respirator, P2, valved

## Welding Respirator

The 3M Welding Respirator provides lightweight, effective, and comfortable respiratory protection. This durable respirator is designed specifically for welding applications to provide protection against ozone and welding fumes, plus relief from nuisance\* odours. It resists clogging and does not require costly and time-consuming maintenance. Like our other disposable respirators, the welding respirator is compatible with 3M eyewear and hearing products. It is also compatible with 3M™ Speedglas™ Welding Shields.



3M Order Code	Model #	Description
70070845089	8514	3M™ Cupped Particulate Welding Respirator, P2, with Nuisance* Level Organic Vapour Relief, valved

## Basic Series VFlex™ Particulate Respirator

The VFlex is a unique addition to 3M's range of disposable particulate respirators. Its V-shaped pleats expand to provide a comfortable seal while giving you a spacious feel. The pleats flex with mouth movement for comfort and to maintain face seal performance.



3M Order Code	Model #	Description
70071676954	1804	3M™ VFlex Particulate Respirator N95 (equivalent to P2 in Australia and New Zealand)
70071676962	1804S	3M™ VFlex Particulate Respirator Small N95 (equivalent to P2 in Australia and New Zealand)

\* Nuisance levels are those levels below the WorkSafe New Zealand Exposure Standards.

# Disposable Respirators

## Specialty Respirators Organic Vapour

The Organic Vapour Specialty Respirators by 3M are developed for particular working environments. These respirators feature an integrated activated carbon layer that offers relief from levels of nuisance\* odours at concentrations below WorkSafe New Zealand exposure standards.

They can be used for a wide variety of applications ranging from mining to weed spraying to waste sorting. The Specialty range provides lightweight, effective, comfortable and hygienic respiratory protection against particles and organic vapours.

### Activated Carbon Layer

- All of these specialty products offer an additional activated carbon layer to filter out ozone and nuisance\* levels of organic vapour



9913



9923V



9542V



9913V

3M Order Code	Model #	Description
WX700900037	9913V	3M™ Cupped Particulate Respirator, GP1 with Nuisance* Level Organic Vapour Relief, valved
WX700900284	9913	3M™ Cupped Particulate Respirator, GP1 with Nuisance* Level Organic Vapour Relief
WX700901902	9923V	3M™ Cupped Particulate Respirator, P2, with Nuisance* Level Organic Vapour Relief, valved
XY003892821	9542V	3M™ Flat Fold Particulate Respirator, P2, with Nuisance* Level Organic Vapour Relief, valved

## Specialty Respirators Acid Gas

The Acid Gas Specialty Respirators by 3M provide lightweight, effective, comfortable and hygienic respiratory protection against particles, with additional relief from nuisance\* levels of acid gases such as sulfur dioxide and hydrogen fluoride.

The cupped shape, twin strap design, foam nose seal and nose clip ensure comfortable wear over a wide range of face sizes.



9916



9926

3M Order Code	Model #	Description
WX700900318	9926	3M™ Cupped Particulate Respirator, P2 with Nuisance* Level Acid Gas Relief, valved
WX700900276	9916	3M™ Cupped Particulate Respirator, P1 with Nuisance* Level Acid Gas Relief, valved

\* Nuisance levels are those levels below the WorkSafe New Zealand Exposure Standards.

## The importance of fit.

Disposable respirators are most effective when there is a good seal between the edges of the respirator and your face. The instant this seal is broken, protection is compromised as contaminated air can leak in through any gaps.

These fitting instructions must be followed each time a 3M™ Aura™ Particulate Respirator 9300A+ Series is worn.



Make sure that your face is clean shaven. Respirators should not be worn with stubble, beards or other facial hair under the area of the face seal as these can prevent a good seal to the face.



Make sure that long hair is tied back and jewellery is removed so that it does not interfere with the seal to the face.



1. With the reverse side up and using the tab, separate the top and bottom panels of the respirator to form a cup shape. Bend slightly at the centre of the noseclip.
2. Ensure that both panels are fully unfolded.



- 3a. Cup the respirator in one hand with the open side towards your face.



- 3b. Take both straps in your other hand. Hold the respirator under your chin, with the nosepiece facing upwards and pull the straps over your head.



4. Locate the upper strap across the crown of the head and the lower strap below your ears. The straps must not be twisted. Adjust the top and bottom panels for a comfortable fit, ensuring that the panels and tab are not folded in.



5. Using both hands, mould the noseclip to the shape of the nose to ensure a close fit and a good seal.

**⚠** The respirator may not fit as well if you pinch the noseclip using one hand. Use two hands.



6. Perform a fit-check by covering the front of the respirator with both hands taking care not to disturb its fit.
  - If you're using an unvalved respirator, exhale sharply.
  - If you're using a valved respirator, inhale sharply.
  - If air leaks around the nose, readjust the noseclip to eliminate leakage then repeat the fit check. If air leaks at the respirator edges, work the straps back along the sides of the head to eliminate leakage then repeat the fit check.
  - If you cannot achieve a proper fit, DO NOT enter the hazardous area. Consult your supervisor.

Noseclip should be moulded around nose and cheeks to give a good seal.

Make sure the panels are fully unfolded.

Respirator should be correctly positioned on your face and head.

Upper strap should be positioned on the crown of the head. Strap should not be twisted.

Lower strap should be positioned below the ears. Strap should not be twisted.

# Healthcare Respirators and Surgical Masks

The 1870+, 1860, 1860S, 1804 and 1804S healthcare respirators are designed to help provide respiratory protection for the wearer by reducing exposure to harmful airborne particles which are small enough to be inhaled – typically particles less than 100 microns in size. These include airborne particles that may contain biological material e.g. Bacillus anthracis, Mycobacterium tuberculosis, mould and the virus that causes Severe Acute Respiratory Syndrome (SARS) and Influenza.

As a disposable particulate respirator, it is intended to reduce wearer exposure to certain airborne particles including those generated by electrocautery, laser surgery, and other powered medical instruments.

As these products are also a surgical mask, it is designed to be fluid resistant to splash and spatter of blood and other infectious materials.

### Features and Benefits:

- NIOSH approved N95
- Meets CDC guidelines for Mycobacterium tuberculosis exposure control
- 3M™ Advanced Electrostatic Media (AEM) - Highly charged microfibres enhance the capture of airborne particles while allowing you to breathe easier
- FDA cleared for use as a surgical mask
- BFE (Bacterial Filtration Efficiency) > 99% and PFE (Particle Filtration Efficiency) > 95% (at 0.3µm particle size) according to ASTM F2101
- Fluid resistant according to ASTM F1862



1860



1860S



1804



1804S

3M Order Code	Model #	Description	Fluid Resistance Level
GT500073009	1870+	3M™ Flat Fold Particulate Respirator & Surgical Mask, N95/P2 with Fluid Resistance	Level 3
AT010607219	1860	3M™ Cupped Particulate Respirator & Surgical Mask (standard size), N95/P2 with Fluid Resistance - standard size	Level 2
XA010000546	1860S	3M™ Cupped Particulate Respirator & Surgical Mask (small size), N95 with Fluid Resistance	Level 1
70071676954	1804	3M™ VFlex™ Healthcare Particulate Respirator and Surgical Mask, N95	Level 1
70071676962	1804S	3M™ VFlex™ Healthcare Particulate Respirator and Surgical Mask, N95 Small	Level 1

# Disposable Respirators



## 3M™ Aura™ Health Care Particulate Respirator and Surgical Mask 1870+

- Individually wrapped to ensure cleanliness of respirator each time
- Flat-fold design allows for convenient storage prior to use
- Embossed top panel helps reduce eyewear fogging
- Sculpted top panel allows more room for eyewear
- Innovative chin tab for ease of positioning, donning, adjustment
- Highest level of fluid resistance according to ASTM F1862 at 160 mm Hg



## 3M™ Health Care Particulate Respirator and Surgical Mask 1860 and 1860S

- Collapse resistant cup shape design
- Braided headbands, cushioning nose foam, and light weight construction for comfortable wear
- Available in 2 sizes to fit a broad range of faces (1860 and 1860S)
- Fluid resistant according to ASTM F1862 at 120 mm Hg (1860) and 80 mm Hg (1860S)



## 3M™ VFlex™ Health Care Particulate Respirator and Surgical Mask 1804 and 1804S

- Uniquely designed tabs for respirator positioning on the face
- Flatfold design allows for convenient storage prior to use
- Pleats help increase surface area for ease of breathing and flex with mouth movement while talking
- Available in 2 sizes to fit a broad range of faces (1804 and 1804S)
- Fluid resistant according to ASTM F1862 at 80 mm Hg



### Potential settings and applications

Operating Rooms, Clinics, TB Wards, Patient Care, Labor and Delivery, Infection Control Practices, Laboratory, emergency or pandemic preparedness planning, stockpiling, etc.

## Selection flowchart.

Use the selector below to identify which respirator may be preferred for increased worker comfort.

### What type of particles are in your environment?

#### Mechanically Generated (P1)

#### Thermally Generated (P2)

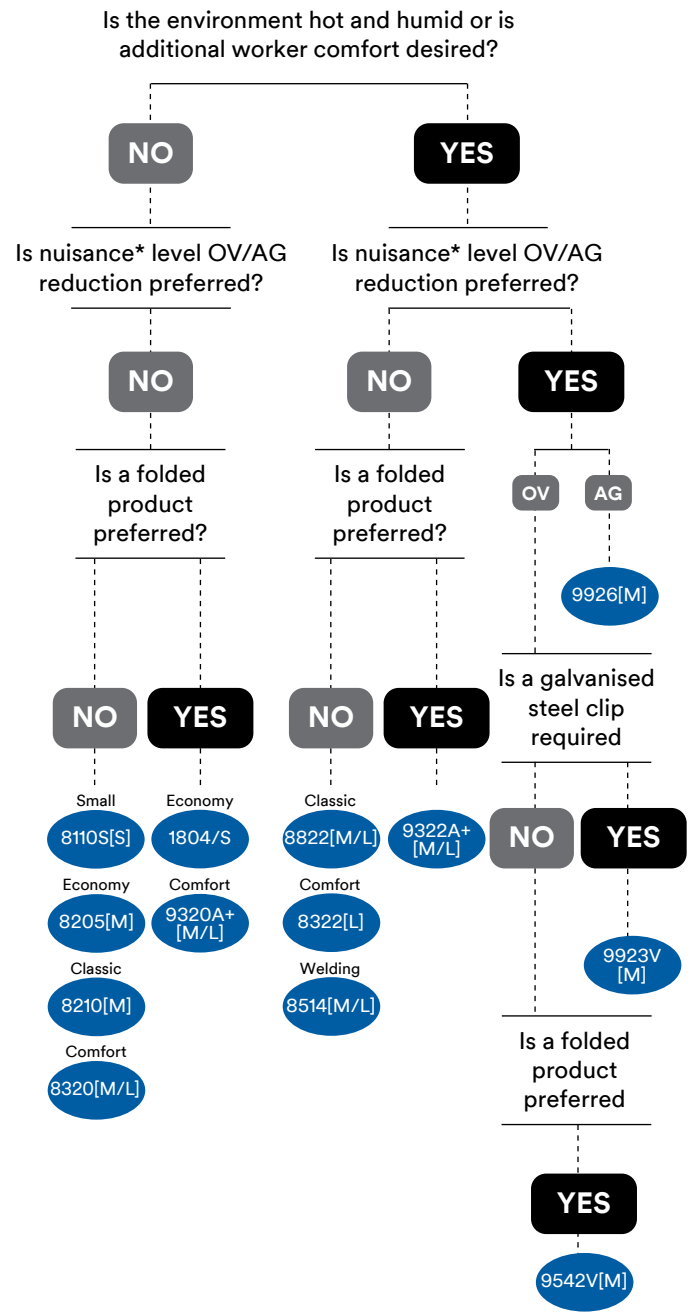
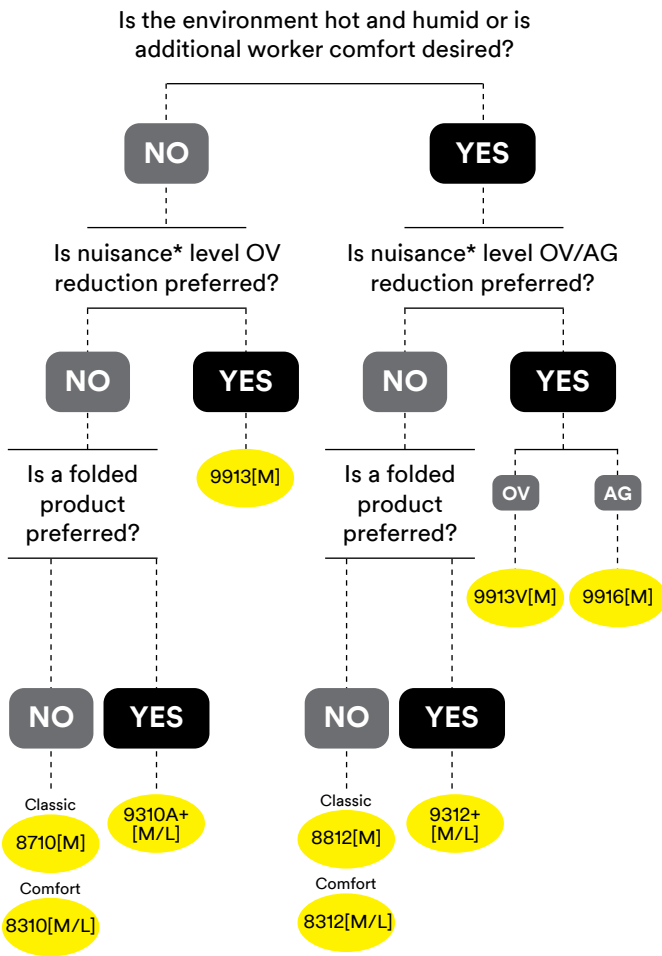

**Key:**

S	Small Size
M	Fits most face shapes and sizes
L	Fits large face sizes
OV	Organic Vapor
AG	Acid Gas

\* Nuisance levels are those levels below the WorkSafe New Zealand Exposure Standards.





# Reusable Respirators

For prolonged periods of use, Half and Full Facepiece respirators by 3M offer exceptional value and quality, all combine comfort with ease of use. 3M™ Respirators have to pass strict quality control tests and provide a consistently high level of safety. The choice of the right facepiece and filter type depends on your particular working environment and individual requirements. 3M can assist you to choose the protection that helps you achieve optimum results.

# 3M™ Reusable Respirators.

## 3M™ Reusable Respirators – Technology Innovations Over the Years:



1977

3M offers the first reusable “Maintenance-Free” Half Facepiece Respirator



1987

3M manufactures a “sweptback” designed cartridge for its 5000 Series Facepiece for better peripheral vision and weight distribution



1989

3M designs and develops the “bayonet-style” cartridge connection



1991

3M develops and incorporates a new integral filter technology in its 4000 Series Facepiece, creating a lighter weight respirator



1992

3M develops first disc filters with loaded web filter media—the first non-woven, non-fiberglass filters



2019

3M introduces next-generation Secure Click™ HF-800SD series respirator providing comfort, breathability and simplicity.



2013

3M introduces the 6500QL Half Facepiece Respirator, our lightest silicone half facepiece



2010

3M develops first Full Facepiece Respirator with Scotchgard™ coating, overmolded gaskets, and comfort head cradle



2002

3M introduces Cool Flow™ Valve for reduced heat and moisture in the 7500 Half Facepiece Respirator



1996

3M launches its 6000 Series Full Facepiece Respirator offering best-in-class field of view and lightweight characteristics



# How a gas and vapour respirator cartridge works.



3M makes gas and vapour respirator cartridges to help reduce user exposure to many different organic vapours. To achieve this objective, respirator cartridges are filled with a material called activated carbon. Activated carbon is typically made from coal or renewable resources like wood or coconut shells. It is “activated” by heating the material in nitrogen or steam at approximate temperatures of 800 – 900°C. The resulting material has a significant number of micropores ideal for removal of organic vapours by adsorption. Adsorption is the adherence of gas or vapour molecules to the surface of the activated carbon. The attractive force between the activated carbon and the chemical molecule is a relative small, weak physical force. These micropores can be measured and optimized for specific product needs and performance.

The activated carbon sorbent bed can be impregnated with chemicals reagents to remove specific gas and vapours by chemisorption. Chemisorption is the formation of bonds between molecules of the impregnate and the chemical contaminant. These bonds are much stronger than the attractive forces of physical adsorption. The binding is usually irreversible.



Coal or renewable resources, such as coconut shells



Coal or renewable resources are heated without oxygen



High-temperature steam or nitrogen activation

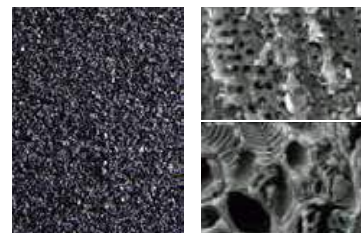

High-grade activated carbon

Electron micrographs of activated carbon pores

Organic vapours are predominantly removed by adsorption. When organic vapours are drawn through a gases and vapour cartridge, the air is filtered as vapours condense into the carbon pores. Vapours move through the cartridge from one pore to the next. This occurs more quickly for small volatile vapours with lower boiling points (e.g., acetone). Some migration of organic vapours can even occur during storage, so care must be taken before reusing the cartridge. The effective service life is the time until vapours begin to exit the cartridge.

Unlike particle filters, service life is not indicated by change in breathing resistance. Instead, cartridges must be changed according to local regulations; or the established filter change schedule. If after establishing the change schedule; the contaminant can be detected sooner inside the respirator by irritation, taste or smell; the change schedule must be adjusted to a shorter change frequency.

Activated carbon by itself cannot adsorb other types of gases or vapours such as acid gases, ammonia, formaldehyde, etc. In some cases, additional metals and salts are added to the carbon to selectively remove these compounds. For this reason, 3M offers a variety of cartridges and facepieces to help protect workers in different environments and satisfy personal preferences.

AS/NZS 1716 uses a classification system to identify the different types of contaminants these filter cartridges capture. 3M Australian and New Zealand rated Filter cartridges follow this marking and colour coding system.

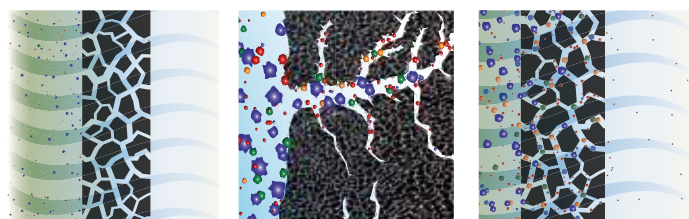

Unfiltered organic vapours are drawn into the cartridge.

Activated carbon absorbs organic vapours on molecular level.

Service life continues until vapours begin to escape the cartridge.

### Factors that influence service life:

- Exposure concentration
- Ambient Temperature
- Humidity Level (water vapour takes up space in carbon pores)
- Class of cartridge e.g. A1, A2

3M is committed to develop quality safety products to help protect workers. For more information about 3M gases and vapour cartridges, please visit [3M.co.nz/ppesafety](https://3m.co.nz/ppesafety).

To establish a cartridge change schedule using the 3M Australia and Select and Service life software please visit <https://sls.3m.com/> and select Australia & New Zealand

# How do particle filters work?

A bed of randomly oriented fibres is used to create the filter. Treated fibres can be used to attract and trap particles as they flow into and through the filter material. Increasing the thickness and capture effectiveness of the filter material increases the filter efficiency at capturing particles. Particle filters are tested according to AS/NZS1716 Section 4.3.5 and Appendix I and L. The physics of particle capture indicates that the particle size range 0.02-0.2 micron equivalent diameter and a mass median particle diameter of approximately 0.3 to 0.6  $\mu\text{m}$  is the most difficult size range to capture. The filter is tested with a sodium chloride challenge aerosol consisting of particles mainly of this size. There are four common mechanisms of filtration being interception capture, inertial impaction and diffusion capture and electrostatic attraction. In practice, particle filters designed for respiratory protection will capture particles of all sizes – the major difference is the relative performance in the range between  $\sim 0.1$  and  $1 \mu\text{m}$ . Each class of filter must perform above a certain level against the test aerosol to be then classified under AS/NZS1716 as explained below.

## What's a P1, P2, P3 rating filter?

A P1 is an AS/NZS1716 rated particle filter for use with Mechanically generated particles e.g. particles generated by crushing, grinding, drilling, sanding, cutting etc including silica, wood dust, mists from spraying.

A P2 is an AS/NZS1716 rated particle filter for use with Mechanically and Thermally generated particles e.g. welding fume. These are also the recommended type for use with airborne particles that may contain biological hazards.

A P3 filter is the highest efficiency particle filter class and is used for particulates that are of high toxicity or at high concentrations. The benefit of this high efficiency filter can only be achieved on a full facepiece respirator system.

## How long do particle filters last?

As particle filters load up with the contaminant, they actually become more restrictive to the passage of particles and can be a better filter. However, they also become harder to breathe through. The wearer will notice this increased load and at some point decide that the restriction is too high and will then need to change the filter. How soon this occurs will also be dependent on the amount of particles in the breathing air. A very dusty job will obviously clog the filter up more quickly than a relatively less dusty job. The change decision point will vary from individual to individual as some people are more sensitive to the increase in breathing load than others. So in summary, the filter should be changed when the breathing resistance becomes excessive to the wearer OR if the filter is damaged in any way eg by welding sparks.

## Are there situations where particle filters must not be used?

There are several applications where particle filters should NOT be used:

- When the ambient Oxygen level is not guaranteed to be  $> 19.5\%$ . Filters do not create oxygen.
- For the capture of gases or vapours - these need a specifically rated gas/vapour filter.
- When the airborne particulate contaminant concentrations are high i.e. greater than the standard allows for that respirator type.
- When Government Regulations require use of airline or other specific type of respirator for specific applications.

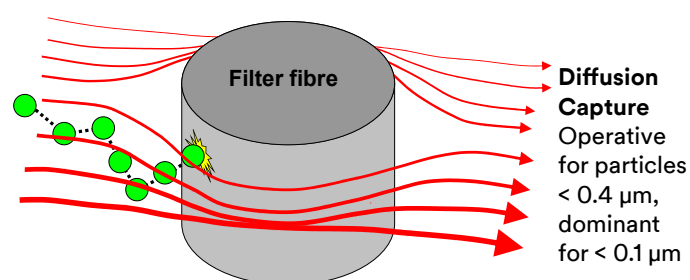
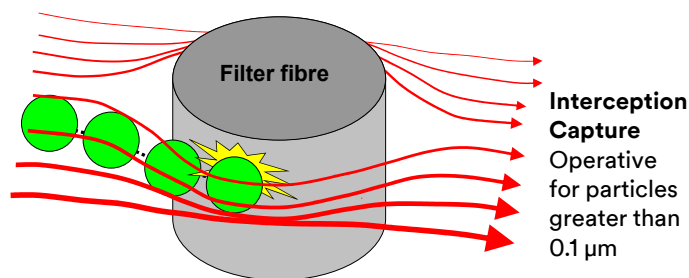
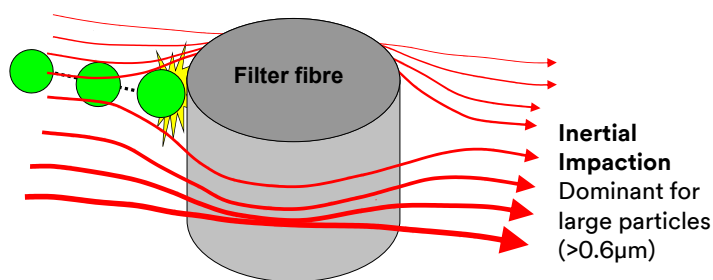

# A respiratory solution for every task.

It's clearly recognised that we need clean air to survive and that exposure to toxins could cause irreparable damage to our health, but sometimes respiratory risks are not obvious or the damage to human respiratory systems occurs over a longer period of time, which is why choosing suitable respiratory protection is important for long term worker health.

AS/NZS 1715:2009 which covers the selection, use and maintenance of respiratory protection equipment states: "The effective management of risks to health is achieved by identifying the hazards, assessing the risk associated with those hazards and controlling the risks to health".

The following summarises the tasks needed to ensure a safe respiratory working environment.

1. Undertake a risk assessment to identify the hazard and if possible remove or reduce the hazard, which is always preferable to using Respiratory Protective Equipment (RPE). If this is not possible, appropriate RPE will need to be selected and implemented, to prevent inhalation of contaminated air.
2. A clearly defined set of selection steps must be followed to determine the type of RPE that is best suited for the job and the contaminant.

Respiratory protective devices are classified into two main groups; Air Purifying Respirators (Filtering devices) and Air Supplied Breathing Apparatus.

Where an Immediately Dangerous to Life and Health (IDLH) atmosphere is identified, air purifying respirators/filtering devices are not suitable, and self-contained and/or air supplied demand breathing apparatus must be used, due to the risk of oxygen displacing gases or other hazards where a filter may not provide appropriate protection from the hazard. RPE are given a Protection Factor (PF), which is a measure of the efficiency of the respiratory protection devices, i.e. if the content of a substance on the inside of the facepiece is one fiftieth of what it is in the ambient air, the respiratory protective device is said to have a Protection Factor of 50.

In addition to identifying the hazard, AS/NZS 1715:2009 states that;

- All users must be trained to use RPE
- RPE must fit properly to prevent leaks around the edges
- Fit-testing must be done before first wearing a tight fitting facepiece
- Beards, moustaches, sideburns, stubble & long hair are not allowed when wearing a tight fitting facepiece
- Cleaning and maintenance of RPE is required.



# Guide to identify respiratory hazards and assess their risk.

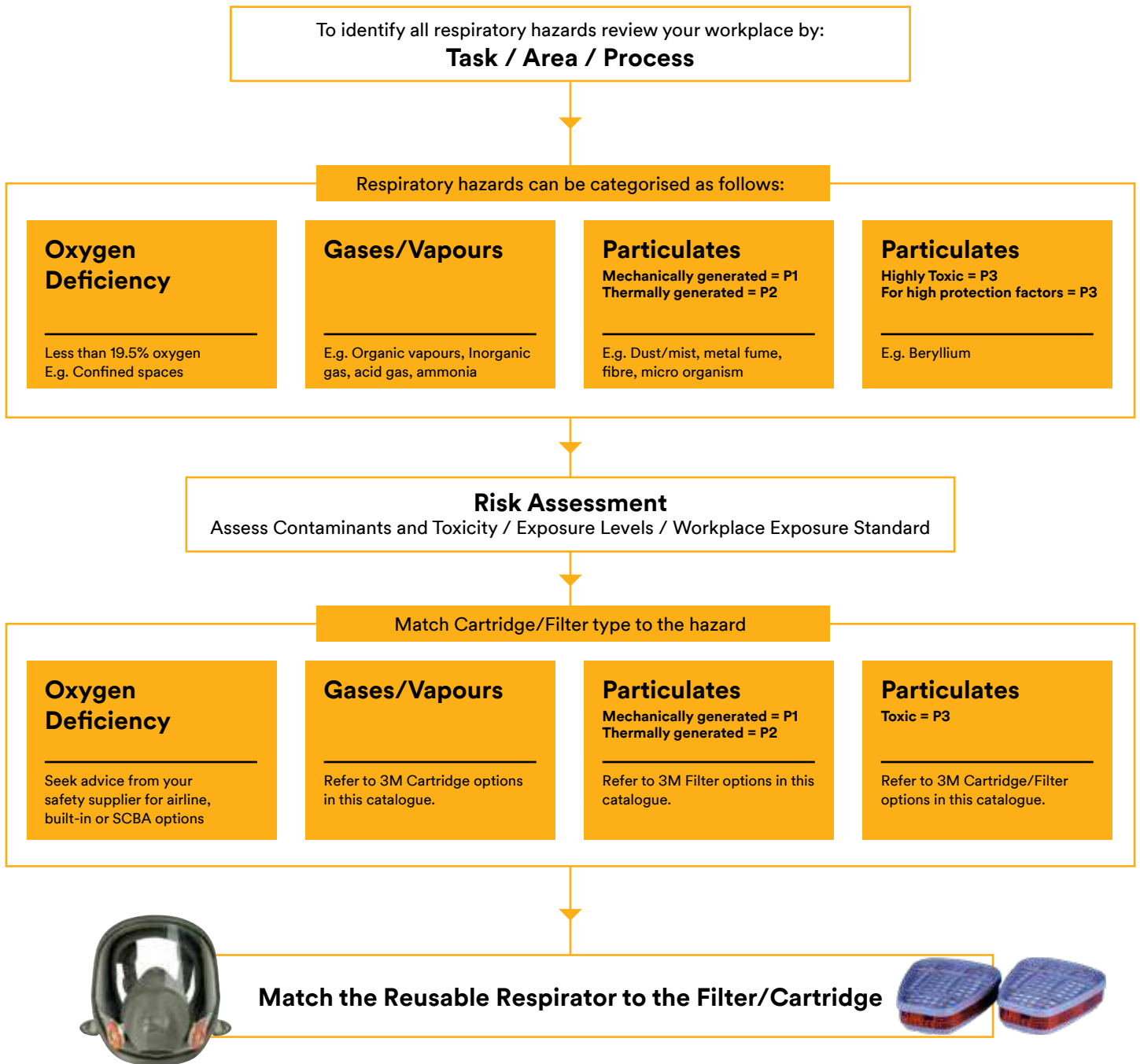

This is a guide only. Selection of the most appropriate personal protective equipment (PPE) will depend on the particular situation and exposure levels and should be made only by a competent person knowledgeable of the assessed risks, actual working conditions and limitations of PPE. Details regarding performance and limitations are set out on the product packaging and user information. If in doubt, contact a safety professional or 3M.

For respiratory training and advice please contact your local 3M representative.

# Hazard identification and protection recommendations.

Industry	Application	Hazard	Recommended Protection
Construction	Painting, spraying, varnishing, coating	Solvent-based paint Solvents, resins, synthetic resins Latex-paint, residual solvents Spray-on glue, foam, varnish, adhesive	A1P2
Metal Fabrication	Welding, metal cutting, metal pouring, soldering, brazing	Metal fumes	P2
	Welding - TIG, MIG and other	Metal fumes, ozone gas. Nuisance levels of organic vapour	GP2
Agriculture	Spraying low vapour pressure*** pesticides, herbicides or fungicides	Organic vapour, mist, dust	GP2
	Mixing pesticide, herbicide or fungicide or spraying organic vapours	Organic vapour, mist, dust	A1P2
Automotive	Cleaning or using organic solvents, degreasing, paint thinners and glues	Organic vapour	A1
	Brush or roller application* of 2 pack type paints	Isocyanates*	A1
Fibreglass	Laying up	Expoxy and polyester resin, amines & anhydride hardner. Methy ethyl ketone peroxide (MEKP), styrene vapour	A1P2
	Using a chopper gun	Glass fibre, dust, resin and styrene vapour	
	Spray painting & cleaning moulds	Organic vapour and mist	
Maintenance	Disinfection, cleaning	Organic vapour, mist and dust	A1P2
		Organic vapour, formaldehyde, mist and dust	ABE1P2
Other	Handling	Ammonia (NH3)**	K
		Bacteria, spores, odours	P2
		Hydrochloric acid vapour or mist**	ABEP2
		Petroleum solvents	A2
		Sulphur dioxide**	E
		Particulates**	P2
		Hazardous goods storage/transport	Seek specialised advice from 3M

\* For protection from Isocyanates when spraying polyurethanes/2 pack, please contact the 3M TechAssist Helpline. \*\*Also need to consider eye/face/skin protection. \*\*\*Low vapour pressure < 1.3Pa @ 25°C. P3 protection is only achieved on a full face respirator.

## Filter selection guide.

Filter Type	Colour	Main area of application
P	White	Particles: Dusts, mists, fumes, fibres, toxic particles & microorganisms (bacteria, fungi, viruses, enzymes)
A	Brown	Organic vapours with boiling point >65°C. eg. Toluene, Xylene, MEK, Benzene, Alcohols
AX	Brown	Highly volatile organic solvents with boiling point <65°C. e.g. Methanol, 1,3-Butadiene, Acetaldehyde
B	Grey	Acid gases, e.g chlorine, hydrogen sulphide, hydrogen chloride
E	Yellow	Inorganic gases such as sulphur dioxide
K	Green	Ammonia and organic ammonia derivatives
Hg	Red	Mercury (vapour)

Application limits for Gas & Vapour respirators (AS/NZS1715):

- Half facepiece respirators can be used up to 10 times the relevant Workplace Exposure Standards (WES) or up to 1000 ppm, whichever limit is reached first.
- Full facepiece respirators can be used up to 50 times the WES with a Class 1 filter or up to 1000 ppm, whichever limit is reached first
- A1 and A2 Cartridges are designed for use with organic vapours with a boiling point above 65°C.
- AX Cartridges are used for organic vapours with a boiling point under 65°C. Note: 3M™ AX Cartridges are single use and can only be fitted to 3M™ Full facepiece respirators.

This selection guide is only an outline designed to focus on products which may be appropriate for typical applications - it should not be used as the only means of selecting a product. Selection of the most appropriate personal protective equipment (PPE) will depend on the particular situation and exposure levels and should be made only by a competent person knowledgeable of the assessed risks, actual working conditions and limitation of PPE. Details regarding performance and limitations are set out on the product packaging and user information. If in doubt, contact a safety professional or 3M.

# Select the right respirator and filter/cartridge.

**6000 Series**

**6500QL Series**

**7500 Series**

**6000 FF Series**

**FF-400 Series**

**3M Twin Bayonet Filters & Cartridges**

**Particulate Protection**

6035 P2/P3\*\* 2125 P2 2135 P2/P3\*\*

**Particulate Protection + Nuisance Level\* Organic Vapour and Acid Gas**

6038 P2/P3\*\* 2128 GP2 2138 GP2/GP3\*\*

**Gas & Vapour Protection only**

6051 A1 6054 K1 6057 ABE1 6059 ABEK1 6075 A1+Form

**Combined Particulate + Gas & Vapour Protection**

6051 A1 6054 K1 6057 ABE1 6059 ABEK1 6075 A1+Form 5925 P2 5935 P3\*\* 501

6096 A1HgP3\*\* 6098 AXP3\*\* 6099 A2B2E2K2P3\*\*

6051 A1 6054 K1 6057 ABE1 6059 ABEK1 6075 A1+Form 502 Adapter 2125, 2128, 2135\*\*, 2138\*\* OR 6035\*\* 6038\*\*

6098 and 6099 are only for use with Full facepiece.

**4000+ Series**

**4277+ A1B1E1P2**

**Combined Particulate + Gas & Vapour Protection**

**Ready to use, Maintenance free**

\* Nuisance Levels are those levels below the Workplace Exposure Standard (WES)  
 \*\* Provides P3 protection only with 3M Full facepiece Respirators. Provides P2 protection with half facepiece respirators.





# Reusable Respirators



HF-800SD Series

  
D3125 P2

  
D3135 P3\*\*

  
D9035 P3\*\*

**Secure Click Filters & Cartridges**  
**Particulate Protection**

  
D3128 P2

  
D3138 P3\*\*

  
D9038 P3\*\*

**Particulate Protection + Nuisance Level\* Organic Vapour and Acid Gas**

  
D8051 A1

  
D8055 A2

  
D8059 A1B1E1K1

**Gas & Vapour Protection Only**

  
D8051 A1  
D8055 A2  
D8059 A1B1E1K1

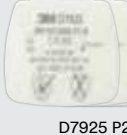
  
D7925 P2

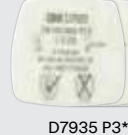
  
D7935 P3\*\*

  
D701

**Combined Particulate + Gas & Vapour Protection**

  
D8094 A1B1E1K1P3\*\*

  
D8095 A2P3\*\*



HF-300 Series (AVIVA 40)



FF-300 (Promask Single) Series



FF-600F (Vision RFF1000) Series



FF-600 (Vision RFF4000) Series

### DT-Series (Pro2000) Filters and Cartridges

  
052670/DT-1135E P3

  
042870/DT-4001E A2

  
042979/DT-4006E A2B2E2K2

  
042674/DT-4035E A2B2P3

  
042671/DT-4032E B2P3

  
042799/DT-4045E A2B2E2K2P3

Model #	Description
052670/DT-1135E	DT-Series (Pro2000) DT-1135E PF10 P3**
042870/DT-4001E	DT Series (Pro2000) DT-4001E GF22 A2
042979/DT-4006E	DT-Series (Pro2000) DT-4006E GF32 A2B2E2K2
042970/DT-4007E	DT-Series (Pro2000) DT-4007E GF32 AX
042670/DT-4031E	DT-Series (Pro2000) DT-4031E CF22 A2-P3**
042671/DT-4032E	DT-Series (Pro2000) DT-4032E CF22 B2-P3**
042674/DT-4035E	DT-Series (Pro2000) DT-4035E CF22 A2B2-P3**
042799/DT-4045E	DT-Series (Pro2000) DT-4045E CF32 A2B2E2K2-P3**
042770/DT-4047E	DT-Series (Pro2000) DT-4047E CF32 AX-P3** For use with full facepieces only
042678/DT-4036E	DT-Series (Pro2000) DT-4036E CF22 A2B2E1-P3**
042568/DT-4045E	DT-Series (Pro2000) DT-4045E CF32 A2B2E2K2-P3** Foil Bag. For use Full facepiece only
042798/DT-4046E	DT-Series (Pro2000) DT-4046E CF32 A2B2E2K2Hg-P3** For use with Full Facepiece only
052692/SC-6601	Pre-Filter Kit SC-6601 For DT-Series (Pro2000). Includes Prefilter and Prefilter Holder

\*\* Provides P3 protection only with 3M Full Facepiece Respirators. Provides P2 protection with half facepiece respirators.

# Select the right respirator.

Half and Full Facepiece Respirators; are offered in a variety of materials and sizes to suit most face sizes and shapes.



Half Facepieces	4000+	HF-300 (AVIVA 40)	6000	6500QL	7500	HF-800SD
Enhanced Durability		✓		✓	✓	✓
Enhanced Comfort		✓		✓	✓	✓
Drop-down Feature	✓	✓		✓	✓	
3M™ Cool Flow™ Valve				✓	✓	
Compatible with 3M™ Supplied Air System			✓	✓	✓	
Silicone Faceseal				✓	✓	✓
Compatible with Welding Shield			✓	✓	✓	✓
Compatible with PAPR system with BT60 tube					✓	
Speech Diaphragm						✓
Filter Type	Integrated	3M DT-Series	3M Twin Bayonet	3M Twin Bayonet	3M Twin Bayonet	3M Secure Click



Full Facepieces	6000	FF-300 (Promask Single)	FF-400	FF-600 (Vision RFF4000)	FF-600F (Vision RFF1000)
Enhanced Durability		✓		✓	✓
Enhanced Comfort	✓		✓		
3M™ Cool Flow™ Valve	✓		✓		
Compatible with 3M™ Supplied Air System	✓	✓		✓	✓
Compatible with 3M™ PAPR Systems	✓	✓		✓	✓
Silicone Faceseal	✓		✓	✓	✓
Speech Diaphragm		✓	✓	✓	✓
Filter Type	3M Twin Bayonet	3M DT-Series	3M Twin Bayonet	3M DT-Series	3M DT-Series

## 3M™ HF-800SD Reusable Respirator

Designed with smart and intuitive features, the 3M™ Half Facepiece Reusable Respirator HF-800SD Series helps protect workers from particulates and a wide variety of gases and vapours when used with approved 3M™ Secure Click™ filters and cartridges.

- Silicone facepiece for comfort and durability
- Work with confidence, provided by the all new Secure Click™ connection
- Provides one-touch button to check on seal check
- Experience the greater breathability and comfort provided by the world's first quad-flow gas and vapour or cartridge
- Speech diaphragm provides easier communication while working

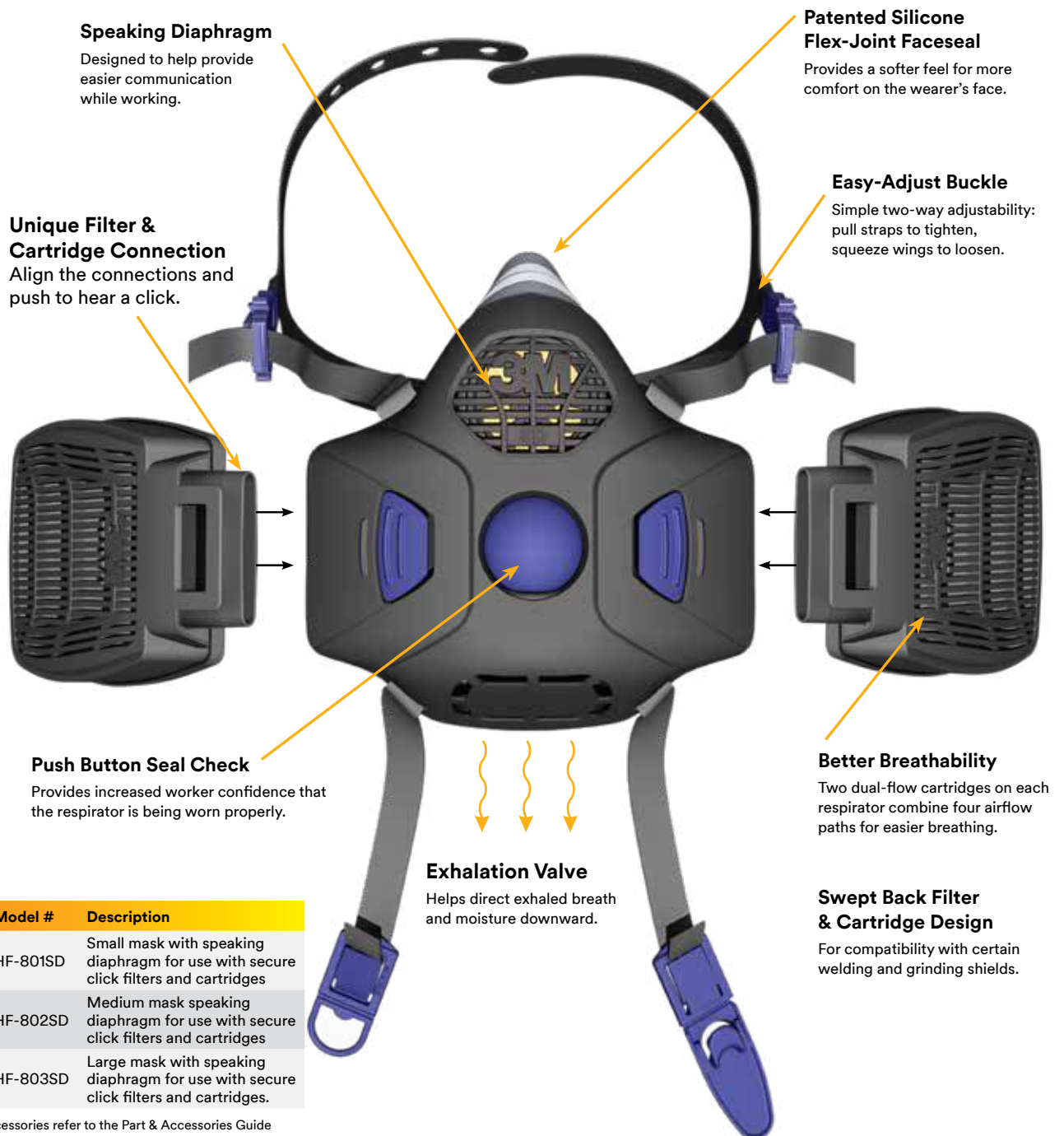

**Speaking Diaphragm**

Designed to help provide easier communication while working.

**Patented Silicone Flex-Joint Face Seal**

Provides a softer feel for more comfort on the wearer's face.

**Easy-Adjust Buckle**

Simple two-way adjustability: pull straps to tighten, squeeze wings to loosen.

**Unique Filter & Cartridge Connection**

Align the connections and push to hear a click.

**Push Button Seal Check**

Provides increased worker confidence that the respirator is being worn properly.

**Exhalation Valve**

Helps direct exhaled breath and moisture downward.

**Better Breathability**

Two dual-flow cartridges on each respirator combine four airflow paths for easier breathing.

**Swept Back Filter & Cartridge Design**

For compatibility with certain welding and grinding shields.

3M Order Code	Model #	Description
NT070013015	HF-801SD	Small mask with speaking diaphragm for use with secure click filters and cartridges
UU009622216	HF-802SD	Medium mask speaking diaphragm for use with secure click filters and cartridges
UU009620970	HF-803SD	Large mask with speaking diaphragm for use with secure click filters and cartridges.

For spare parts and accessories refer to the Part & Accessories Guide

# Reusable Respirators

## 3M™ 7500 Series Reusable Respirator

The 3M™ Half Face Reusable Respirator 7500 Series has a soft, silicone face seal for greater comfort and durability. The 3M™ Cool Flow™ Valve helps make breathing easier and can reduce heat and moisture build-up for cool, dry comfort. Combine with a broad range of twin, lightweight 3M filters or cartridges to provide respiratory protection against particulates and a variety of gases and vapours.

- Soft, silicone facepiece for comfort and durability
- Drop down feature for added convenience during breaks
- Thin nose bridge area for reduced pressure and improved comfort
- 3M Cool Flow Exhalation valve offers reduce breathing resistance
- Respirator design helps reduce fogging when wearing eye protection
- Flexible system for use with 3M gas, vapour and particulate cartridges and filters
- Maintainable through a range of spare parts



3M Order Code	Model #	Description
XA007709323	7501	Small for use with 3M™ Twin Bayonet Filters & Cartridges
XA007709331	7502	Medium for use with 3M™ Twin Bayonet Filters & Cartridges
XA007709349	7503	Large for use with 3M™ Twin Bayonet Filters & Cartridges

For spare parts and accessories refer to the Part & Accessories Guide

## 3M™ 6500QL Series Reusable Respirator

- Overmolded / Low-Profile Design
- Optimum fit and comfort with three-size-adjustable head cradle
- Silicone Faceseal provides comfort and stability with a soft but firm faceseal
- 3M™ Cool Flow™ Valve for Easier breathing
- Reusable respirator with quick latch drop down mechanism for easy on and off as wearers move in and out of contaminated areas
- Textured face seal minimises slippage and improves comfort



3M Order Code	Model #	Description
70071668134	6501QL	Small for use with 3M™ Twin Bayonet Filters & Cartridges
70071668142	6502QL	Medium for use with 3M™ Twin Bayonet Filters & Cartridges
70071668159	6503QL	Large for use with 3M™ Twin Bayonet Filters & Cartridges

For spare parts and accessories refer to the Part & Accessories Guide

# Reusable Respirators

## 3M™ HF-300 (AVIVA 40) Series Reusable Respirator

- Hybrid Reflex Seal: unique face seal flexes on the face for increased comfort and fit
- Specially blended super comfortable material without the use of silicone
- Integrated voice panel, for enhanced voice intelligibility
- Goggle pinch – allows better integration with eyewear
- Extremely low breathing resistance eases the respiratory burden on the wearer's lungs
- Downward facing exhale valve avoids misting to eyewear



3M Order Code	Model #	Description
UU011540422	8005000ANZ	HF-301 Small for use with certain DT-Series (Pro2000) filters
UU011540042	8005001ANZ	HF-302 Medium for use with certain DT-Series (Pro2000) filters
UU011540034	8005002ANZ	HF-303 Large for use with certain DT-Series (Pro2000) filters

For spare parts and accessories refer to the Part & Accessories Guide

## 3M™ 6000 Series Reusable Respirator

- Provides lightweight, easy-to-use, economical protection
- An economical choice
- Facepiece is made from soft, lightweight thermoplastic elastomer
- Head harness assembly and spare parts available



3M Order Code	Model #	Description
XA007702633	6100	Small for use with 3M™ Twin Bayonet Filters & Cartridges
XA007702658	6200	Medium for use with 3M™ Twin Bayonet Filters & Cartridges
XA007702674	6300	Large for use with 3M™ Twin Bayonet Filters & Cartridges

For spare parts and accessories refer to the Part & Accessories Guide

## 3M™ 4000+ Series Reusable Respirator

- Disposable, maintenance-free half face respirator
- Twin inhalation valves and large, bonded carbon filters with permanently attached particulate filters
- Easy to use as no need for assembly, maintenance or record keeping



3M Order Code	Model #	Description
UU008107490	4277+	A1B1E1P2

## Reusable Respirators

# 3M™ Reusable Half Face Respirator Starter Kits.

These kits are designed to offer respiratory protection in a convenient and easy way – an ideal solution to get you started. The kits provide protection for a range of applications, from spray painting to sanding or welding. To avoid moisture and contaminant exposure, the respirator is housed in a handy, sealable storage container.

### 3M™ HF-300 (AVIVA 40) Spraying Ready-Pak

Complete respirator kit with HF-300 (AVIVA 40) half face respirator and a DT Series (Pro2000) filter & Pre-filter. Packed in a convenient re-sealable storage container for mask and filter protection. Front mounted DIN40 filter thread compatible with the DT Series (Pro2000) filter range. Certified to AS/NZS 1716:2012.

\*Not to be used when spraying isocyanate based paints



3M Order Code	Model #	Description
UU011565916	8005007ANZ	HF-3014 (AVIVA 40) Spraying Ready-pak A2P2, Small
UU011565601	8000645/HF-3024	HF-3024 (AVIVA 40) Spraying Ready-pak A2P2, Medium
UU011565353	8000646/HF-3034	HF-3034 (AVIVA 40) Spraying Ready-pak A2P2, Large

For spare parts and accessories refer to the Part & Accessories Guide

### 3M™ Spraying Respirator Kit 7551

A convenient respiratory kit designed for certain painting\* and spraying environments. The kit comes complete with the 3M™ Half Face Reusable 7500 Series Respirator for comfort and durability. The 3M™ Cool Flow™ Exhalation Valve reduces breathing resistance and minimizes heat build-up.

\*Not to be used when spraying isocyanate based paints



3M Order Code	Model #	Description
NT019446581	7551S	Spraying Respirator Kit - A1P2 Small
NT019446573	7551M	Spraying Respirator Kit - A1P2 Medium
NT019446565	7551L	Spraying Respirator Kit - A1P2 Large

For spare parts and accessories refer to the Part & Accessories Guide

### 3M™ Spraying Respirator Kit 6551QL

A convenient respiratory kit designed for certain painting\* and spraying environments. The kit comes complete with the 3M™ Half Face Reusable 6500QL Respirator for comfort and durability. It features 3M™ Cool Flow™ Exhalation Valve which reduces breathing resistance and minimize heat build-up. The Quick Latch drop down mechanism provides ease in donning and doffing the face piece.

\*Not to be used when spraying isocyanate based paints



3M Order Code	Model #	Description
AT010787870	6551QL	Spraying Kit-A1P2 Small
AT010787862	6551QL	Spraying Kit-A1P2 Medium
NT019446599	6551QL	Spraying Kit-A1P2 Large

For spare parts and accessories refer to the Part & Accessories Guide

### 3M™ Spraying Respirator Kit 6251

A convenient respiratory kit designed for certain painting\* and spraying environments. The kit comes complete with the 3M™ Half Face Reusable 6000 Series Respirator for comfort and durability. The 3M™ Cool Flow™ Exhalation Valve reduces breathing resistance and minimizes heat build-up.

\* Not to be used when spraying isocyanate based paints



3M Order Code	Model #	Description
NT019447951	6251	Spraying Respirator Kit - A1P2 Small
NT019447969	6251	Spraying Respirator Kit - A1P2 Medium
NT019447977	6251	Spraying Respirator Kit - A1P2 Large

For spare parts and accessories refer to the Part & Accessories Guide

# Reusable Respirators

## 3M™ Welding Respirator Kit 7528

Includes a 3M™ Half Face 7500 Series Respirator with special Cool Flow™ valve and soft silicone material. Ideal for working in hot and humid conditions or during prolonged use.



3M Order Code	Model #	Description
NT019447993	7528	Welding Respirator Kit - GP2 Medium

For spare parts and accessories refer to the Part & Accessories Guide

## 3M™ Welding/Particulate Kit 6528QL

The kit comes complete with the 3M™ Half Face Reusable 6500QL Respirator for comfort and durability. It features 3M™ Cool Flow™ Exhalation Valve that reduces breathing resistance and minimizes heat build-up. The Quick Latch drop down mechanism provides ease in donning and doffing the face piece.



3M Order Code	Model #	Description
NT019446615	6528QL	Welding/Particulate Kit-GP2 Small
NT019446607	6528QL	Welding/Particulate Kit-GP2 Medium
NT019446599	6528QL	Welding/Particulate Kit-GP2 Large

For spare parts and accessories refer to the Part & Accessories Guide

## 3M™ Multi-Gas Respirator Kit 6259

Includes a 3M™ Half Face 6000 Series Respirator that is simple and lightweight.  
\*Not to be used when spraying isocyanate based paints



3M Order Code	Model #	Description
NT019447985	6259	Multi-Gas Respirator Kit-A1B1E1K1P2 Medium

For spare parts and accessories refer to the Part & Accessories Guide

# Reusable Respirators

## 3M™ Construction Respirator Kit 6535QL

The kit comes complete with the 3M™ Half Face Reusable 6500QL Respirator for comfort and durability. It features 3M™ Cool Flow™ Exhalation Valve that reduces breathing resistance and minimizes heat build-up. The Quick Latch drop down mechanism provides ease in donning and doffing the face piece.



3M Order Code	Model #	Description
NT019449288	6535QL	Construction Respirator Kit-P2 Small
NT019448009	6535QL	Construction Respirator Kit-P2 Medium
NT019448017	6535QL	Construction Respirator Kit-P2 Large

For spare parts and accessories refer to the Part & Accessories Guide

## 3M™ Asbestos/Dust Respirator Kit 7535

A convenient respiratory kit designed for certain\*\* asbestos tasks and environments containing dust. The kit comes complete with the 3M™ Half Face Reusable Respirator 7500 Series for comfort and durability. The respirator design helps reduce fogging when wearing eye protection (eyewear included).



3M Order Code	Model #	Description
AT010601592	7535S	Asbestos/Dust - P2/P3 Small
AT010601600	7535M	Asbestos/Dust - P2/P3 Medium
AT010601618	7535L	Asbestos/Dust - P2/P3 Large

For spare parts and accessories refer to the Part & Accessories Guide

## 3M™ Dust/Particle Respirator Kit 6225

Includes a 3M™ Half Face 6000 Series Respirator that is simple and lightweight.



3M Order Code	Model #	Description
NT019447928	6225	Dust/Particle Respirator Kit-P2 Small
NT019447936	6225	Dust/Particle Respirator Kit-P2 Medium
NT019447944	6225	Dust/Particle Respirator Kit-P2 Large

For spare parts and accessories refer to the Part & Accessories Guide

## 3M™ HF-300 (AVIVA 40) Asbestos Dust Ready-Pak

Includes 3M™ HF-300 (AVIVA 40) Reusable Respirator with integrated voice panel, for enhanced voice intelligibility.



3M Order Code	Model #	Description
NT070008239	8005003ANZ	HF-300 (AVIVA 40) Asbestos Dust Ready-pak P2, Small
NT070008098	8000643ANZ	HF-300 (AVIVA 40) Asbestos Dust Ready-pak P2, Medium
NT070008106	8000644ANZ	HF-300 (AVIVA 40) Asbestos Dust Ready-pak P2, Large

For spare parts and accessories refer to the Part & Accessories Guide



## 3M™ Full Face Respirator FF-400 Series

### Features and Benefits:



#### Durable, Long-lasting Head Harness

- Features a six-strap configuration for a secure fit
- Harness straps pulled over one million times in development durability testing

#### Large Lens Featuring Scotchgard™ Protector

- Paint and stain-resistant lens – 3M's exclusive Scotchgard™ coating causes some paints and stains to bead up on the surface so they can be wiped off easily
- Helps lens stay clearer during some spray applications
- Provides a wide field of view

#### Comfort Cradle

- Respirator attachments twist on and off easily for quick assembly and disassembly

#### Soft, Silicone Nose Cup and Face Seal

- Engineered for maximum durability, comfort and resilience
- Three sizes help the respirator fit a broad range of face shapes and sizes

#### Passive Speaking Diaphragm

- Optimally positioned for clearer and easier communications

#### Easy to Use

- Respirator attachments twist on and off easily for quick assembly and disassembly

#### Cool Flow™ Valve

- Allows for easier breathing
- Reduces heat and moisture buildup for cool, dry comfort

#### Bonded Silicone Gaskets

- Eliminate loose gaskets that can be lost

3M Order Code	Model #	Description
70071510773	FF-401	Ultimate FX Full Face Respirator Small - for use with 3M™ Twin Bayonet Filters & Cartridges
70071510807	FF-402	Ultimate FX Full Face Respirator Medium - for use with 3M™ Twin Bayonet Filters & Cartridges
70071510831	FF-403	Ultimate FX Full Face Respirator Large - for use with 3M™ Twin Bayonet Filters & Cartridges

For spare parts and accessories refer to the Part & Accessories Guide

# Reusable Respirators

## 3M™ 6000 Series Full Face Respirator

The 3M™ Full Face Reusable Respirator 6000 Series is simple to use and comfortable to wear. Combined with a broad range of twin, lightweight 3M™ filters or cartridges to provide respiratory protection against particulates and a variety of gases and vapours.

- 3M™ Full Facepiece Respirators 6000 Series, Reusable
- Soft, silicone face seal for greater comfort and durability
- Wide field of vision
- Polycarbonate visor
- Lightweight design with silicone face seal enhances comfort and improves durability
- Unique centre adapter to direct exhaled breath and moisture downward, helps reduce debris from depositing in the valve, and allows for quick and easy cleaning
- Flexible system for use with 3M gas, vapour and particulate cartridges and filters
- Can also be used with 3M Supplied-Air Systems
- Available in four different modes; can be used with both negative and powered and supplied-air systems



3M Order Code	Model #	Description
XA007708234	6700	Small for use with 3M™ Twin Bayonet Filters & Cartridges
XA007708242	6800	Medium for use with 3M™ Twin Bayonet Filters & Cartridges
XA007708259	6900	Large for use with 3M™ Twin Bayonet Filters & Cartridges

For spare parts and accessories refer to the Part & Accessories Guide

## 3M™ FF-300 (Promask Single) Series Full Face Respirator

- DIN40 threaded filter connection
- Wide range of high performance DT-Series (Pro2000) filters available to address a variety of hazards
- Non allergenic halo butyl face piece with wide panoramic polycarbonate visor
- Five point adjustable head harness provides increased wearer comfort and fit
- Speech diaphragm provides clear and audible speech transmission
- Polycarbonate visor



3M Order Code	Model #	Description
UU010978961	012670/FF-301	FF-301 Small for use with DT-Series (Pro2000) filters
UU010978953	012681/FF-302	FF-302 Medium/Large for use with DT-Series (Pro2000) filters

For spare parts and accessories refer to the Part & Accessories Guide

# Reusable Respirators

## 3M™ FF-600F (Vision RFF1000) Series Full Face Respirator

- The Vision visor provides a virtually unrestricted (98%) field of vision
- The visor curves through both the vertical and horizontal planes and remains optically perfect to prevent any visual distortion
- Hard coated to provide solvent and scratch resistance for low through-life costs
- Filters sit low and close to the face, providing excellent balance and weight distribution
- Front mounted filter
- Polycarbonate visor



3M Order Code	Model #	Description
UU011565585	FF-601F	FF-601F (Vision RFF1000) Full Face Front Fitting Filter Small - for use with DT-Series (Pro2000) Filters
UU011565593	FF-602F	FF-602F (Vision RFF1000) Full Face Front Fitting Filter for use with DT-Series (Pro2000) Filters

For spare parts and accessories refer to the Part & Accessories Guide

## 3M™ FF-600 (Vision RFF4000) Full Face Respirator

- The Vision visor provides a virtually unrestricted (98%) field of vision
- The visor curves through both the vertical and horizontal planes and remains optically perfect to prevent any visual distortion
- Hard coated to provide solvent and scratch resistance for low through-life costs
- Filters sit low and close to the face, providing excellent balance and weight distribution
- Side mounted filter
- Polycarbonate visor



3M Order Code	Model #	Description
XP100550118	FF-601 (RFF4000S)	Vision Full Face Mask Side Filter Small - for use with DT-Series (Pro2000) Filters
XP100544962	FF-603 (RFF4000)	Vision Full Face Mask Side Filter Medium/Large - for use with DT-Series (Pro2000) Filters

For spare parts and accessories refer to the Part & Accessories Guide

## Reusable Respirators

# 3M™ Reusable Full Face Respirator Starter Kit.

A convenient respiratory kit designed for certain asbestos tasks\* painting\* and spraying and environments containing dust. The kit comes complete with the 3M™ Full Face Reusable 6000 Series Respirator for comfort and durability. The respirator is simple and easy to use, well balanced and provides a wide field of vision.

### 3M™ Asbestos/Dust Respirator Kit 6835, P3



### 3M™ Spraying/Painting Respirator Kit 6851 A1P2

\*Not to be used when spraying isocyanate based paints



3M Order Code	Model #	Description
AT010614199	6835S	Asbestos/Dust - P3 Small
AT010614207	6835M	Asbestos/Dust - P3 Medium
AT010614215	6835L	Asbestos/Dust - P3 Large

For spare parts and accessories refer to the Part & Accessories Guide

3M Order Code	Model #	Description
AT010614173	6851M	Spraying/Painting - A1P2 Medium
AT010614181	6851L	Spraying/Painting - A1P2 Large

For spare parts and accessories refer to the Part & Accessories Guide



# Reusable Respirators

## 3M™ Twin Bayonet Particulate Filters Series

- Made from 3M high performance filter media for effective filtration efficiency
- Lightweight and provides low breathing resistance
- Suitable for use with 3M™ 6000/6500QL/7500 Series Half Face Respirators and 3M™ 6000 and FF-400 Series Full Face respirators



3M Order Code	Model #	Description
TI551152299	5925	P2 Particulate Filter for use with 603 filter adapter or 6000 Series gas/vapour cartridges. Requires 501 filter retainer
TI551152356	5935	P3** Particulate Filter for use with 603 filter adapter or 6000 Series gas/vapour cartridges. Requires 501 filter retainer
70071731957	501	Filter Retainer for 5925 Particulate Filter for use with 603 filter adapter or 6000 Series gas/vapour cartridges.
70070313211	502	Filter Adapters. Use to attach 3M™ Particulate Filters 2000 Series and 6035/6038 filters, to the 3M™ Cartridges 6000 Series. One time use only. Disposed with cartridge.
CR180811885	6035	P2/P3 Particulate Rectangular White Filter
CR180811893	6038	P2/P3 Particulate Rectangular with Nuisance OV/AG
70071486180	2125	P2 Particulate Disc Filter
70071486206	2135	P2/P3 Particulate Disc Filter
70071486198	2128	GP2 Particulate, Ozone & Nuisance Level OV/AG Disc Filter
70071486214	2138	GP2/GP3 Particulate, Ozone & Nuisance Level OV/AG Disc Filter
70070757912	2076	P2HF Particulate & Hydrogen Fluoride Disc Filter

\*\* Provides P3 protection only with 3M Full Facepiece Respirators. Provides P2 protection with half facepiece respirators.

## 3M™ Twin Bayonet 6000 Series Gas and Vapour Cartridge Series

3M Order Code	Model #	Description
UU006790313	6051	A1 Organic Vapour
UU006790354	6057	A1B1E1 Organic Vapour/Acid Gas Cartridge
GT500084055	6054	K1 Ammonia/Methylamine Cartridge
UU006790370	6075	A1 Formaldehyde Cartridge
UU006790362	6059	A1B1E1K1 Multi Gas Cartridge
70071695228	6096	A1E1HgP3 Organic Vapour/Acid Gas/Mercury/Chlorine/Particulate Cartridge
70071617974*	6098	AXP3 Organic Vapour & Particulates. For use with Full facepiece only
70071695210*	6099	A2B2E2K2HgP3+Formaldehyde. For use with Full facepiece only

\* Use with Full facepiece only

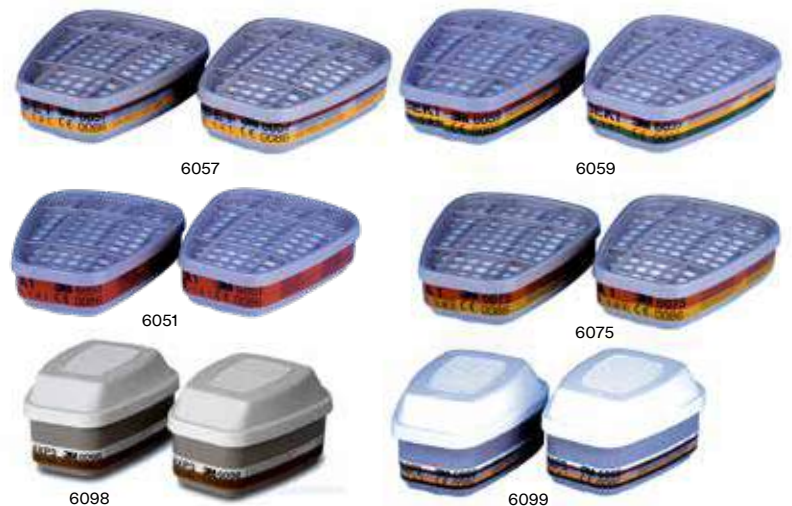

## Approved Filter Combinations



# Reusable Respirators

## 3M™ Secure-Click™ Filters and Cartridges



D8051 A1



D8055 A2



D8094 A1B1E1K1P3\*\*



D8059 A1B1E1K1



D8095 A2P3\*\*

### Secure Click Gas and Vapour Cartridges

3M Order Code	Model #	Description
UU009286772	D8051	Secure Click™ Dual Flow Cartridge A1
UU009288695	D8055	Secure Click™ Dual Flow Cartridge A2
UU009288406	D8059	Secure Click™ Dual Flow Cartridge A1B1E1K1
UU009289347	D8094	Secure Click™ Dual Flow Cartridge A1
UU009289339	D8095	Secure Click™ Dual Flow Cartridge A2P3**



D9035 P3\*\*



D9038 P3\*\*



D3076HF P2



D701



D3138 P3\*\*



D3125 P2



D3135 P3\*\*



D3128 P2



D7925 P2



D7935 P3\*\*

### Secure Click Particulate Filters

3M Order Code	Model #	Description
70071731221	D3125	Secure Click™ Particulate Filter P2
70071731247	D3128	Secure Click™ Particulate Filter P2 with Nuisance Level OV/AG*
70071731262	D3135	Secure Click™ Particulate Filter P2/P3**
70071731288	D3138	Secure Click™ Particulate Filter P2/P3** with Nuisance Level OV/AG*
70071731312	D7925	Secure Click™ Particulate Filter P2. Requires D701 to connect to D8000 Series
70071731320	D7935	Secure Click™ Particulate Filter P2/P3**. Requires D701 to connect to D8000 Series
UU010049979	D701	Secure Click™ Filter Retainer. Required to connect D7925/7935 to D8000 Series
UU010285664	D9035	Secure Click™ Hard cover Particulate Filter P3**
UU010291761	D9038	Secure Click™ Hard Cover Particulate Filter P3** with Nuisance Level OV/AG*
70071731361	D3076HF	Secure Click™ Particulate Filter P2HF with Nuisance. Level Acid gas and Hydrogen. Fluoride up to 10x the WES.

Use with HF-800SD Half Face Respirator only. \*Organic Vapour/Acid Gas. \*\*Provides P3 protection only with 3M Full Face Respirators. Provides P2 protection with half face piece respirators.

## Approved Filter Combinations



HF-800SD Series



D8051 A1  
D8055 A2  
D8059 A1B1E1K1



D7925 P2

OR



D7935 P3\*\*



D701

# Reusable Respirators

## DT-Series (Pro2000) Filters and Cartridges



052670/DT-1135E P3\*\*



042870/DT-4001E A2



042979/DT-4006E A2B2E2K2



042674/DT-4035E A2B2P3\*\*



042671/DT-4032E B2P3\*\*



042799/DT-4045E A2B2E2K2P3\*\*

3M Order Code	Model #	Description
UU011502539	052670/ DT-1135E	DT-Series (Pro2000) DT-1135E PF10 P3**
UU011546916	042870/ DT-4001E	DT-Series (Pro2000) DT-4001E GF22 A2
UU011546940	042979/ DT-4006E	DT-Series (Pro2000) DT-4006E GF32 A2B2E2K2
UU011546973	042970/ DT-4007E	DT-Series (Pro2000) DT-4007E GF32 AX
UU011502554	042670/ DT-4031E	DT-Series (Pro2000) DT-4031E CF22 A2-P3**
UU011502562	042671/ DT-4032E	DT-Series (Pro2000) DT-4032E CF22 B2-P3**
UU011502570	042674/ DT-4035E	DT-Series (Pro2000) DT-4035E CF22 A2B2-P3**
UU011502596	042799/ DT-4045E	DT-Series (Pro2000) DT-4045E CF32 A2B2E2K2-P3**
UU011546965	042770/ DT-4047E	DT-Series (Pro2000) DT-4047E CF32 AX-P3** For use with Full Face facepiece only
UU011507462	042678/ DT-4036E	DT-Series (Pro2000) DT-4036E CF22 A2B2E1-P3**
XP100547460	042568/ DT-4045E	DT-Series (Pro2000) DT-4045E CF32 A2B2E2K2-P3** Foil Bag. For use with Full facepiece only
UU011502588	042798/ DT-4046E	DT-Series (Pro2000) DT-4046E CF32 A2B2E2K2Hg-P3** For use with Full facepiece only
XP100544434	052692/ SC-6601	Pre-Filter Kit SC-6601 For DT-Series (Pro2000) filters. Includes Prefilter and Prefilter Holder
XP100544442	052693	DT-Series (Pro2000) SC-6607 Filter Covers Orange Polyethylene
XP100544269	042507	Filter End Caps (1Pc)
XP100218930	5052694	Filter Shower Cover



\*\*Provides P3 protection only with 3M Full Face Respirators. Provides P2 protection with half face piece respirators.

# The importance of monitoring 3M™ Gas Diffusion Monitors.

Knowing the specific contaminant and exposure levels is important to determine the appropriate respirator, and cartridge or filter for your work environment. This information will also help in estimating the life of selected 3M™ Gas and Vapour Cartridges. If exposure levels are not known, advice and monitoring is required.

While 3M™ does not carry out exposure assessments or monitoring, we do offer 3M™ Gas Diffusion Monitors (below) which can be a useful starting point. 3M Gas Diffusion Monitors are simple and effective devices that collect certain airborne contaminants using the principle of diffusion. They assist in the assessment of exposure to workplace contaminants, both personal and background. These monitors are easy to use and simply clip onto the shirt, collar or pocket. Contact the 3M™ TechAssist Helpline for further information on chemicals which can be captured and approved laboratories for monitor analysis.

### 3M™ Organic Vapour Monitor 3500+

3M™ Organic Vapor Monitor 3500+ is a cost-effective and convenient way to perform personal air sampling for many organic vapors.

3M™ Organic Vapor Monitor 3500+ uses diffusion, rather than a pump, to collect an air sample with an accuracy of +/-25%, at a 95% confidence level for many workplace organic vapors, for both personal or area sampling. It contains a single charcoal sorbent wafer for easy collection of organic vapors and can be used for most applications. This monitor has a 2-year shelf life from its production date.



### 3M™ Formaldehyde Monitor 3721+

3M™ Formaldehyde Monitor 3721+ is a cost-effective and convenient way to perform personal air sampling for formaldehyde and certain other aldehydes.

3M™ Formaldehyde Monitor 3721+ uses diffusion, rather than a pump, to collect an air sample with an accuracy of +/-25% at a 95% confidence level for certain aldehydes found as workplace contaminants. It has fiberglass coated with 2,4-dinitrophenylhydrazine (DNPH) for easy collection of aldehydes and is typically used in health care, laboratories, and in the chemical, pulp/paper, foundry and textile industries. This monitor has a 1-year shelf life from its production date.



### 3M™ Ethylene Oxide Monitor 3551+

3M™ Ethylene Oxide Monitor 3551+ is a cost-effective and convenient way to perform personal air sampling for ethylene oxide.

3M™ Ethylene Oxide Monitor 3551+ uses diffusion, rather than a pump, to collect an air sample with an accuracy of +/-25% at a 95% confidence level. It has a single treated charcoal sorbent wafer for easy collection of ethylene oxide and is typically used in pharmaceutical, health care and chemical industries. This monitor has a 1-year shelf life from its production date.



### 3M™ Organic Vapour Monitor 3501+, High Sampling Rate

3M™ Organic Vapor High Sampling Rate Monitor 3501+ is a cost-effective and convenient way to perform personal air sampling for low levels of organic vapors and short term exposure limit (STEL) sampling.

3M™ Organic Vapor High Sampling Rate Monitor 3501+ uses diffusion, rather than a pump, to collect an air sample with an accuracy of +/-25%, at a 95% confidence level for many workplace organic vapors, for both personal or area sampling. It contains 562 sampling ports to generate high sampling rates and is designed to detect organic vapors at low concentrations or during short-term (STEL) sampling when low detection limits are important.



3M Order Code	Model #	Description
70071765252	3500+	Organic Vapour Monitor
70071765286	3501+	Organic Vapour High Sampling Monitor
70071765310	3551+	Ethylene Oxide Monitor
70071765344	3721+	Formaldehyde Monitor

This monitor has a 2-year shelf life from its production date.

**Monitors must be received by the testing Laboratories within the recommended holding time between sampling and lab analysis. Contact your testing laboratory for their specific laboratory request form.**





# Fit Testing

It's more than just products, it's knowing how to wear them that helps bring you home safely at the end of your workday.

# Why is fit testing so important?

The biggest contributor to reduced respiratory protection is poor fit. Checking that a respirator, with a tight fitting facepiece provides an adequate seal to the wearer's face has long been considered best practice as part of a general Respiratory Protection Program.

Reflecting this, a fit test for wearers tight fitting facepieces is required for compliance to AS/NZS 1715:2009. Respirators with tight fitting facepieces include disposable respirators, half and full-face respirators, including those that form part of a powered or air-fed respirator.

### Fit testing should be carried out:

- Before the respirator is issued
- On all wearers of respirators with tight fitting facepieces where fit testing has previously not been performed

### Fit testing should be repeated at appropriate times such as:

- If the wearer significantly loses or gains weight, has major dental work or sustains a major facial injury
- If a different size or model of Respiratory Protective Equipment (RPE) is specified
- Annually or when specified by the company policy e.g. during a health surveillance check
- Fit testing is in addition to performing a self-fit check. Prior to entering the contaminated area, at each use, the wearer should carry out a self-fit check to test the respirator fit.

### There are two main methods of fit testing available:

- Qualitative fit testing (Aerosol Taste Test ATT)
- Quantitative fit testing (Ambient Aerosol Condensation Nuclei Counter (CNC) and Controlled Negative Pressure (CNP))

You can contact 3M for qualitative and quantitative fit testing advice. During both methods of testing, it is essential that the person is free from facial hair and other items that may interfere with the face seal.

Wearers with facial hair or stubble (even a day's growth) must not wear a respirator which has a tight fitting facepiece. All tests require a series of exercises to be performed during the fit test. Manufacturer's instructions for the test equipment should be followed at all times.

A record of the result of the test should be generated and retained for at least 5 years. Some schools of thought consider these records to be identifiable to an individual and related to health controls; in which case records may need to be kept for 40 years. Check with your local regulatory authorities to determine their requirements.

Tight Fitting positive pressure facepiece e.g. Full facepiece on a PAPR or Self Contained Breathing Apparatus are also required to be fit tested. However when being fit tested the facepiece must be converted into a negative pressure facepiece irrespective of the mode it is used in on the job.

For more information on the requirements of Fit Testing, refer to the AS/NZS 1715:2009 & ISO 16975-3.

## 3M™ Qualitative Fit Test Kits

Conduct a fit test to ensure that a respirator with a tight fitting facepiece provides an adequate seal to the wearer's face.

The 3M Qualitative Fit Test apparatus FT-10 and FT-30 are designed for fit testing disposable respirators and half face reusable respirators fitted with particulate or combination gas/vapour and particulate filters.

### Features and Benefits:

- Offers a convenient method for performing qualitative fit testing
- No calibration of equipment required
- No modification of facepiece required
- Training resources available, please contact your local 3M representative for more information
- Each kit contains a hood and collar assembly, two nebulisers, sensitivity solution, test solution and detailed instructions
- Replacement solutions and accessories can be purchased separately
- Available with Sweet (FT-10) or Bitter (FT-30) solutions



3M Order Code	Description
70070121515	3M™ Qualitative Fit Test Apparatus Kit FT-10, Sweet (Saccharin)
70070121457	3M™ Sensitivity Solution FT-11, Sweet (Saccharin)
70070121465	3M™ Fit Test Solution FT-12, Sweet (Saccharin)
70070121481	3M™ Fit Test Hood FT-14
70070709640	3M™ Qualitative Fit Test Apparatus Kit FT-30, Bitter (Bitrex)
70070709657	3M™ Sensitivity Solution FT-31, Bitter (Bitrex)
70070709665	3M™ Fit Test Solution FT-32, Bitter (Bitrex)

3M NZ supports the New Zealand Occupational Hygiene Society (NZOHS) Commit2Fit respirator fit testing training and competency scheme. Commit2Fit aims to increase the number of fit testers and to ensure a minimum level of competency is achieved so fit testing is correct and reliable. Visit [www.nzohs.org.nz/commit2fit/](http://www.nzohs.org.nz/commit2fit/) for further information



# Fit Testing

## Quantitative (QNFT) CNC Fit Test Adapters



3M Order Code	Model #	Description
70070406544	601	QNFT-CNC Fit Test adapter for 3M Twin bayonet facepieces (Half facepiece - 6000, 6500QL & 7500. Full facepiece - 6000 & FF-400)
UU009620905	HF-800-03	QNFT-CNC Fit Test adapter for HF-800SD Half Face
XP100544970	RXFTA/STAN	QNFT-CNC Fit Test adapter for HF-300 (Aviva 40), FF-300 (Promask Single), FF-600 (Vision RFF4000), FF-600F (Vision RFF4000), 6000DIN and Powerflow
XP100100492	2003468	QNFT-CNC Fit Test adapter for Scott Fire & Safety SCBA face pieces (Promask PP and Vision PP)



**3M** Science.  
Applied to Life.™



# Powered Air Purifying Respirators

Providing clean breathing air is essential when working in areas where hazardous contaminants are present. 3M offers an extensive and flexible range of industrial powered and supplied air respirators, developed especially for the toughest environments. These respiratory protective systems offer comfortable protection against multiple hazards and their ease-of-use enables improved productivity in the workplace. 3M is available to support the user in the correct selection, training and proper use of these products.

**#3MScienceOfSafety**

# Powered Air Purifying Respirators.

Powered Air Purifying respirators (PAPRs); include a blower that draws contaminated air through filter/s to remove contaminants, supplying purified air to the user wearing either an open head top (loose fitting hood) or tight-fitting face mask. Like full and half face masks, PAPRs are also available in ready-packs to simplify the respiratory selection process.

### 3M offers a range of ready-to-go PAPR kits:

- Full face masks for asbestos and dust applications
- Half and full hood head tops ideal for chemical and pharmaceutical industry
- Helmets and face shields ideal for welding applications.

### The benefits of a PAPR are:

- Protection factors up to 100+, based on the headtop and filter/cartridge being used
- Good option if using for long periods by reducing the weight of a filter carried on a face mask
- Helps prevent user fatigue with air moving around the head and face cooling the wearer
- Available with a wide range of open and closed head tops (hoods & masks).
- Respirators that rely upon positive air flow through a loose-fitting headtop do not require face fit testing.

These features make PAPRs ideal for industries such as; asbestos removal, pharmaceutical manufacture, smelters, waste control, land remediation, welding and agriculture. With any negative pressure or PAPR RPE the selection and use of the correct filter for the contaminant/hazard is crucial. Filters are typically designed to handle particulates, gas/vapour or a combination of both particulate and gas.

The life of a gas cartridge is dependent upon the temperature, humidity, concentration and type of contaminant, the class of filter and the rate of breathing of the wearer. Filters should be replaced on a regular basis in accordance with an established filter replacement schedule identified in the initial risk assessment. AS/NZS 1716: 2012 recommends discarding your filter when any one of the following conditions exists:

- The particulate filter becomes difficult to breathe through
- Breakthrough gas occurs; indicated by smell or taste or according to the filter replacement schedule identified during the risk assessment
- 6 months has passed since sealed gas/vapour filter package has been opened
- The expiry date on the filter has passed.

In some instances, depending on the type of chemical hazard, filters must be changed out after each shift.

If filters are to be re-used they should be stored in a sealed plastic bag or box.

### Filter classifications:

#### Particulate Filters are classified as P1, P2 or P3:

- P1 filters handle mechanically generated particles
- P2 filters handle mechanical & thermally generated particles
- P3 filters handle mechanical & thermally generated particles

#### Gas filters are rated Class 1, Class 2 or Class 3 according to their capacity to capture and hold certain gas/vapours

The classification for gas & vapour filters is based on the groups of gases they are designed to be most effective against. Filters have colour-coded labels for easy identification of the different groups.

# Experience maximum flexibility as you move from one job to the next.

## New levels of comfort and simplicity

3M offers an extensive and flexible range of powered and supplied air respirators developed for a wide range of environments, applications and hazards.

These respiratory protective systems offer comfortable, integrated protection against multiple hazards providing respiratory, head, face, eye and hearing protection. Their ease of use can improve productivity in the workplace.

- 1 All 3M™ Versaflo™ Brand Products are light-weight, compact and well-balanced
- 2 Two-position adjustable airflow feature distributes air where the user wants
- 3 Multiple size adjustment options allow for a comfortable fit
- 4 Equipped with automatic flow control, low battery alarm, and low flow alarm
- 5 QRS (Quick Release Swivel) breathing tubes allow fast and easy connection
- 6 Provides excellent peripheral and downward vision
- 7 Easily removable parts allow simple cleaning, maintenance and replacement
- 8 The air inlet draws air from the bottom of the unit, allowing the wearer to sit without blocking the airflow intake



# Which air system should I choose?

### A powered air system?

- Incorporates a battery powered motorised fan to draw air through a filter
- Cannot be used to protect against substances with poor warning properties (taste/smell)
- Must not be used in conditions that are Immediately Dangerous to Life or Health (IDLH)
- Suitable for use over long shifts - reduced breathing resistance
- Can offer integrated head, eye and face protection

### A supplied air system?

- Air is supplied from a compressor (compressed air must be of breathable quality)
- Can be used to protect against substances with poor warning properties (taste/smell)
- Must not be used in conditions that are Immediately Dangerous to Life or Health (IDLH)
- Suitable for use over long shifts - reduced breathing resistance
- Can offer integrated head, eye and face protection



### Powered Air Respirators



3M™ Versaflo™  
Powered Air  
Turbo TR-300+



3M™ Versaflo™  
Powered Air  
Turbo TR-600



3M™ Versaflo™  
Powered Air  
Turbo TR-800



### Supplied Air Systems



3M™ Versaflo™  
Supplied  
Air Unit V-100



3M™ Versaflo™  
Supplied  
Air Unit V-200



3M™ Versaflo™  
Supplied  
Air Unit V-300



3M™ Versaflo™  
V-500  
Regulators  
V-Series



Supplied  
Air System  
Stethoscope

# Powered Air Purifying Respirators

## Modular Systems



The modular respirator system is a comprehensive approach to worker protection systems based on comfortable-to-wear modules. All modular headtops, air delivery units and breathing tubes are compatible with one another. Users can mix and match parts as they move from one environment to another, or from one application to the next. It is the ultimate in flexibility for handling changing user environments.

## Individual Systems



The individual respirator systems can be used in a variety of workplace applications. They include powered air respirators with integrated head, eye, face and respiratory protection and supplied air regulators with half and full face masks.

## Selection process for modular systems.

### Powered air systems

#### Stage 1A

Select Powered Air Turbo\*

#### Stage 1B

Select Filters, Battery and Belt



#### Stage 2

Select your Headtop



#### Stage 3

Select your Breathing Tube



#### Stage 4

Choose Accessories



\*Want an even easier way to select a system? Choose 3M's powered air starter kits, which include everything apart from the headtop and some accessories.

### Supplied air systems

#### Stage 1

Select your Air Panel



#### Stage 2

Select your Compressed Air Supply Tube



#### Stage 3

Select your Regulator



#### Stage 4

Select your Headtop



#### Stage 5

Select your Breathing Tube



#### Stage 6

Choose Accessories





## Modular respirator systems.

**3M™ Versaflo™ Headcovers and Hoods S-Series**

Integrated Suspension      Reusable Suspension

S-133 S/L      S-433 S/L      S-655  
S-333G S/L      S-533 S/L      S-657  
S-757      S-855E

**3M™ Versaflo™ Headtops M-Series**

Faceshields      Helmets      Helmets with Shrouds

M-206      M-306      M-406  
M-207      M-307      M-407

**Breathing Tubes and Accessories**

BT-20 S/L: Lightweight (in two lengths)  
BT-30: Self-adjusting  
BT-40: Heavy-duty rubber  
BT-922: Polyethylene Clear Cover\*  
BT-926: Flame-resistant Cover  
BT-927: Radiant Heat Cover

BT-20 S/L      BT-30      BT-40      BT-922      BT-926      BT-927

\*Breathing tube not included

**Powered air turbos**

Particulate only (nuisance level organic vapour and acid gas options available)      Particulate + Gas & Vapour      Intrinsically Safe Particulate + Gas & Vapour

3M™ Versaflo™ Powered Air Turbo TR-300+      3M™ Versaflo™ Powered Air Turbo TR-600      3M™ Versaflo™ Powered Air Turbo TR-800 Intrinsically safe

**TR-300 Filter**

- Spark Arrestor
- Prefilter
- P3 Filter
- P3/Nuisance Level Organic Filter
- P3/Nuisance Level Acid Gas (HF up to 10 x WES)

**Battery**

- Standard battery
- High capacity battery

**Charger**

- Single Station Battery Charger
- 4-Station Battery Charger Kit

**TR-600 & TR-800 Filter**

- Spark Arrestor
- Prefilter
- P3 Filter
- P3/Nuisance Level Organic Vapour/Acid Gas
- A1P3 Filter
- ABEHgP3 Filter

**TR-600 Battery**

- Standard Battery
- High Capacity Battery

**TR-600 & TR-800 Chargers**

- Single Station Bat. Charger
- 4-Station Bat. Charger Kit

**TR-830 Battery**

- TR-830 Intrinsic Safe Battery for use with TR-800

# Powered Air Purifying Respirators

## 3M™ 6000 Series Full Face Respirator and 3M™ 7500 Series Reusable Respirator

Full Face



6000

Half Face



7500

## Individual respirator systems.



**Belt-mounted powered air respirator system for asbestos environments**

PF-600E-ASB (Proflow SC160)  
Asbestos ReadyPak



**Face-mounted powered air respirator**

3M™ Powerflow™  
Powered Air System

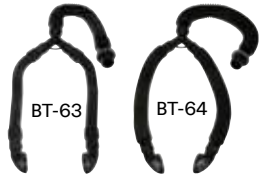

BT-63

BT-64



BT-953

TR-973

### BT63/64 Breathing tube accessories

BT-953 Versaflo™  
Cleaning & Storage Kit  
TR-973 Versaflo™ Air  
Flow Indicator

## Supplied air regulators

Air Cooling



3M™ Vortex  
Supplied  
Air Unit V-100

Air Heating



3M™ Vortex  
Supplied  
Air Unit V-200



3M™ Versaflo™  
Supplied  
Air Unit V-300

Flow Controlled



3M™ Versaflo™  
Supplied  
Air Regulator V-500



Stethoscope Airline system

## Airline Components

Air Supply Hose



## 3M™ Versaflo™ TR-800 Powered Air Purifying

- The Versaflo TR-800 features a PAPR blower UL-certified with an intrinsically safe (IS) rating of Division 1: IS Class I, II, III; Division 1 (includes Division 2) Groups C, D, E, F, G; T4, under the most current standard (UL 60079, 6th Edition, 2013). Safety in Mines Testing and Research Station (Simtars) IECEX SIM 19.0013.
- LED indicators on the turbo indicate battery charge level, particulate filter loading status and airflow setting
- Low flow and low battery alarms - Visual, Audible and Vibratory
- Vibratory, audible and visual alarms assure you can hear, see and feel when your PAPR has low-charge or low-flow
- Compatible with multiple configurations of headtops, breathing tubes, batteries, filters, cartridges and more
- Ergonomically designed to fit close to the body and allow for greater movement in tight work spaces
- Multi-speed blower functions at altitudes up to 4,880 metres. Battery offers long run time and charges quickly, achieving 90% charge in approximately 3.5 hours.
- Multiple airflow rates put you in control of your comfort.
- Battery comes with built in charge level indicator, a mechanical attachment of battery to help prevent battery removal during use. Approximately 750 full charge/discharge cycles.
- Intuitive, coloured touchpoints plus visual and audible lowflow indicators help make the TR-800 easy to use.



### Comfortable airflow

- Three user selectable flow rates to maximise comfort
- Controlled airflow delivers steady flow as battery discharges or filter loads with particulates



### Innovative materials

### Ease of use

- Intrinsically safe TR-800 Series display shows battery charge status and particulate filter loading status during use
- **Battery charge indicator** - charge status is also indicated by a useful LED display on the battery



- No user calibration of turbo required
- Electronic audible and visual alarm in case of low battery and/or low air flow

### Battery Protection

Battery features bumpers to help absorb impacts



### Easy identification

Bright yellow touchpoints to differentiate from non-IS versions of Versaflo Product Family

### Secure battery attachment

Mechanical attachment of battery to help prevent battery removal and spark risk during use per EN 60079-11



3M Order Code	Model #	Description
70071732666	TR-819A	TR-819A IS PAPR Starter Kit including battery and charger 1/CS
70071697117	TR-830	Battery, Intrinsically safe 1/CS*
70071697133	TR-851	Filter latch assembly
70071697125	TR-838	Battery attachment tool
70071730900	TR-802E	PAPR Motor/Blower 1/CS
AT010784307	901-00-87	28L Tote bin for PAPR kits
AT010601550	S1303-0166	Versaflo™ Storage Bag

### Mining Atmospheres IEC 60079-11 Ex ia I Ma

ia - intrinsic safety- safe with rare malfunction  
I - Mining group  
Ma - Equipment protection level mining

### Motor/Blower Safety

### Non-Mining Gas atmospheres (Group II)

EN 60079-11 Ex ia IIB T4 Ga  
ia - intrinsic safety for Equipment protection level Ga  
IIB - Gas apparatus group  
T4 - Max. surface temperature 135°C (-20°C ≤ Ta ≤ 55°C)

### Non-Mining Dust atmospheres (Group III)

EN 60079-11 Ex ia IIIC 135°C Da  
ia - intrinsic safety for Equipment protection level Da  
IIIC - Dust apparatus group  
135°C - Max surface temperature 135°C (-20°C ≤ Ta ≤ 55°C)

\*purchase filter and filter cover separately. For spare parts and accessories refer to the Part & Accessories Guide.

# Powered Air Purifying Respirators

## 3M™ Versaflo™ Powered Air Purifying Respirators TR-600

- LED indicators on the turbo indicate battery charge level, particulate filter loading status and airflow setting
- Low flow and low battery alarms - Visual, Audible and Vibratory
- On-battery fuel gauge
- Vibratory, audible and visual alarms assure you can hear, see and feel when your PAPR has low-charge or low-flow
- Compatible with multiple configurations of headtops, breathing tubes, batteries, filters, cartridges and more
- Ergonomically designed to fit close to the body and allow for greater movement in tight work spaces



AT010620147



3M Order Code	Model #	Description
70071697000	TR-619A	Versaflo™ Powered Air Turbo Starter Kit TR-619A includes battery charger, excludes filter and filter cover
70071667862	TR-602E	Powered Air Turbo unit
52000053547	TR-630	Standard Battery TR-630
52000053554	TR-632	Versaflo™ High Capacity Battery
52000053570	TR-641E	Single Station Charger to Suit Versaflo™ TR-632 battery
52000053588	TR-644E	4 Station Charger to Suit the Versaflo™ TR-632 Battery
70071651692	TR-655/37385	Backpack adapter plate 1/C
78815045279	TR-627	Easy Clean belt
70071622081	TR-651	Filter Latch TR-651
70071618428	TR-653	Cleaning & Storage Kit to suit Versaflo™ TR Systems
70071618253	TR-662	Spark Arrestor TR-662 to suit Versaflo™ TR-600
70071668076	TR-971	Airflow Indicator for TR-600 Versaflo™ Unit
70071730884	TR-973	Air Flow Tube TR-600
78815045279	TR-627	Easy Clean Belt with Adaptor plate
52000053521	TR-626	High Durability Belt to Suit TR-602 Versaflo™ AFU
AT010784307	901-00-87	28L Tote bin for PAPR kits
AT010601550	S1303-0166	Versaflo™ Storage Bag

For more spare parts and accessories refer to the Part & Accessories Guide

## PAPR Breathing Hoses



3M Order Code	Model #	Description
70071533015	BT-20L	Fixed length lightweight Polyurethane Breathing Tube L=965mm
70071533023	BT-20S	Fixed length lightweight Polyurethane Breathing Tube L=735mm
XA007706584	BT-30	Self-adjustable Polyurethane Breathing Tube L=525-850mm
UU003085113	BT-40	Fixed length Heavy Duty Neoprene Breathing Tube L=840mm
XA007706527	BT-922	Breathing Tube Cover Polyethylene Clear - 1 per case*
70071564432	BT-926	Flame Resistant Breathing Tube Cover - 1 per case

\*Breathing tube not included

## TR-600 & TR-800 Filters

3M Order Code	Model #	Description
70071622073	TR-6500FC	Filter Cover to Suit Versaflo™ TR -6580ANZ
NT070007777	TR-6580ANZ	A1B1E1HgP3 Filter For Organic Vapours, Acid Gases, Inorganic vapours and Mercury vapour including a P3 Filter
70071622065	TR-6300FC	Filter Cover to Suit Versaflo™ TR -6310ANZ P3 Filter
NT070007769	TR-6310ANZ	A1P3 Filter For Organic Vapours includes a P3 filter
70071622040	TR-6800FC	Filter Cover to Suit Versaflo™ TR -6820ANZ Nuisance Odour* P3 Filter
UU008996207	TR-6820ANZ	Nuisance Odour* Plus P3 Filter
70071618261	TR-6700FC	Filter Cover to Suit Versaflo™ TR-6710ANZ
NT070007736	TR-6710ANZ	High Efficiency Filter Versaflo™
70071618246	TR-6600	Versaflo™ Pre-Filter

## BT-63 & BT-64 Breathing Tube

For use with the 7500 half face and 6000 series full face respirators on the TR-600 or TR-800 PAPR Units.



3M Order Code	Model #	Description
70071730876	BT-64	Versaflo™ Heavy Duty Tight Fitting Breathing Tube BT-64 1 EA/Case
70071730934	BT-63	Versaflo™ Length Adjusting Tight Fitting Breathing Tube BT-63 1/Case
70071730892	BT-953	Versaflo™ Cleaning & Storage Kit BT-953, for BT-63/64 Breathing Tubes 1/case
70071730884	TR-973	Versaflo™ Air Flow Indicator TR-973, for TR-600 PAPR with BT-63/64 Breathing Tube 1/case

# Powered Air Purifying Respirators

## 3M™ Versaflo™ Powered Air Purifying Respirators TR-300+

The 3M™ Versaflo™ PAPR TR-300+ is significantly lighter and thinner than past generations of 3M™ Belt-Mounted PAPR units. It also keeps its light weight close to the user's back, reducing the leverage effect that can cause PAPRs to feel heavier. The slim profile is designed for use in tight spaces, and its smooth, contoured outer surfaces are less prone to snagging on nearby objects.

- Two user selectable flow rates 185 & 205 l/min
- Controlled airflow delivers steady flow as battery discharges or filters loads with particulates
- Display shows battery charge status, selected airflow and particulate filter loading status during use
- Audible and LED alarm signals low battery charge or low airflow
- Three filter options available: P3 Particle, P3 Particle plus nuisance level organic vapours\* & P3 Particulate only nuisance acid gas \* and offers protection against hydrogen fluoride up to 10 x Occupational Exposure Limit
- Lithium ion battery with LED to indicate charge status
- Three belt options (standard, easy-clean and leather) for a range of applications
- Ingress Protection rated IP53
- Nuisance level refers to concentrations below the Occupational Exposure Limit
- Compliant with AS/NZS 1716:2012



3M Order Code	Model #	Description
UU006386286	TR-315A+	Versaflo™ Integrated Powered Air Respirator system includes air filter unit, P3 Filter, standard belt, pre-filter, breathing tube, battery pack, battery charger, tote bin and user instructions

For spare parts and accessories refer to the Part & Accessories Guide

## Jupiter™ Turbo System (Discontinued, offered while stock available)

Jupiter Air Turbo Unit includes turbo case, motor, blower, decontamination belt, battery and instructions. Battery Charger and Breathing Tube is not included.



3M Order Code	Model #	Description
XH000724704		Jupiter complete with battery excl headtop & filters 1/CTN
XA007706071	085-01-00P	Blower Module
XA007706253	085-06-10P	Control Module - Jupiter
52000043803	007-00-64P	NIMH Battery Pack
AT010596396	003-00-58PAUS	Battery Charger, CHG-02
52000044579	085-12-00	Jupiter IS 4Hr Battery & pouch each 1/CTN

For spare parts and accessories refer to the Part & Accessories Guide

## TR-315A+ Filters & accessories

3M Order Code	Model #	Description
CR180811422	TR-3600	Versaflo™ Prefilter (replaced 78815069378)
70071765054	TR-3712E	Versaflo™ Filter Particulate, P3
78815069386	TR-3802E	Filter P3 plus Nuisance Organic Vapour
78815069394	TR-3822E	Filter P3 & HF Plus Nuisance Acid Gases
UU006386278	TR-302E	Air Filter Unit
XA007706568	TR-332	Battery Pack
XA007706758	TR-341A	Single Station Battery Charger
XA007706766	TR-344A	Quad Station Battery Charger

## Jupiter™ Filters (Jupiter PAPR discontinued, offered while stock available, filters available till December 2022)



3M Order Code	Model #	Description
CR180806000	450-00-25	Particulate Filter - P3 PAPR
CR180806018	453-00-25P	Organic Vapor & Particulate Filter - A1P3
CR180806042	453-09-25	Multigas & Particulate - A1B1E1K1P3 PAPR
CR180804708	461-00-02P24	Pre Filter Discs - 24 per pack

# Versaflo™ M-200 Series High Impact Faceshield

The Versaflo M-200 Series High Impact Faceshield provides integrated protection from specific respiratory, eye and face hazards with optional hearing protection. Two options for different applications:

- M-207 features a flame resistant face seal for applications with hot particles
- M-200 offers a full headtop protection, eliminating the need of head inserts being needed.
- Compatible with TR-300+, TR-600, TR-800, Jupiter units and supplied air regulators V-100, V-200, V-300, V-500
- M-200 has replaced M-100 Series Headtop



M-207

3M Order Code	Model #	Description
UU009055615	M-207	Faceshield with FR PolyFace Seal
XA007702583	H31P3AF	Earmuffs for M-Series Head Tops, M200 = Class 3, M-300 = Class 4

For spare parts and accessories refer to the Part & Accessories Guide

# Versaflo™ M-300 Series High Impact Helmet

The Versaflo M-300 Series High Impact Helmet provides integrated protection from specific respiratory, head, eye and face hazards with optional hearing protection. Two options for different applications:

- M-307 features a flame resistant faceseal for applications where hot particles may be present.
- Compatible with TR-300+, TR-600, TR-800, Jupiter units and supplied air regulators V-100, V-200, V-300, V-500



3M Order Code	Model #	Description
XA007707475	M-307	Versaflo Helmet with coated visor and flame resistant faceseal
AT010782079	M-306CAP	M-306 Headtop only with Cap Lamp Mount Bracket*
UU006077661	M-973	Radiant Heat Cover for M-300
UU006081861	M-961	Over Visor Frame
UU006081887	M-967	Gold Over Visor UV/IR (Shade 5)
XA007702583	H31P3AF	Earmuffs for M-Series Head Tops, M-200 = Class 3, M-300 = Class 4

For spare parts and accessories refer to the Part & Accessories Guide.

\*Does not include lamp.

# Versaflo™ M-400 Series High Impact Helmet with Neck Protector

The Versaflo M-400 Series High Impact Helmet provides integrated protection from specific respiratory, head, eye and face hazards with neck and shoulder protection. Two options for different applications:

- M-406 features general purpose faceseal for dusts, spraying and chemical processing.
- M-407 features a flame resistant faceseal and neck shroud for applications where hot particles may be present.
- Compatible with TR-300+, TR-600, TR-800, Jupiter units and supplied air regulators V-100, V-200, V-300, V-500



M-406



M-975

3M Order Code	Model #	Description
XA007707483	M-406	Versaflo Helmet with high durability neck and shoulder shroud
XA007707491	M-407	Versaflo Helmet with flame resistant neck and shoulder shroud
UU006077679	M-975	Radiant Heat Cover for M-400
UU006081861	M-961	Over Visor Frame
UU006081887	M-967	Gold Over Visor UV/IR (Shade 5)

For spare parts and accessories refer to the Part & Accessories Guide



## Powered Air Purifying Respirators

# Versaflo™ S-Series Hoods & Headcovers

Compatible with TR-300+, TR-600, TR-800, Jupiter units and supplied air regulators V-100, V-200, V-300, V-500



S-333SG



S-133L



S-855



S-757



S-433L



S-657



S-655



S-533L

3M Order Code	Model #	Description
52000045824	S-133L	Head Cover (Large) with integrated head harness, headtop fabric, spun bond polypropylene
52000045865	S333SG	Low lint Head Cover (Small/Grey) with integrated head harness - 1 per box, headtop fabric, polyurethane coated knitted nylon
52000045881	S333LG	Low lint Head Cover (Large/Grey) with integrated head harness - 1 per box, headtop fabric, polyurethane coated knitted nylon
52000045923	S-433L	Hood (Large) with integrated head harness - 1 per box, headtop fabric, spun bond polypropylene
52000045964	S-533L	Low Lint Hood (Large) with integrated head harness - 1 per box, headtop fabric, polyurethane coated knitted nylon
UU003722327	S-655	Hood with replaceable head suspension - 1 per box, headtop fabric, spun bond polypropylene
UU003722335	S-657	Double Shroud Hood with replaceable head suspension - 1 per box, headtop fabric, spun bond polypropylene
UU003719109	S-757	Double Laminate Hood with replaceable head suspension - 1 per box, headtop fabric, spun bond polypropylene
70071533338	S-855	Sealed seam hood with replaceable head harness - 1 per box, headtop fabric, spun bond polypropylene

For spare parts and accessories refer to the Part & Accessories Guide

## Powered Air Purifying Respirators

# Powerflow™ Powered Air Purifying Respirator

Powerflow includes 6000 DIN series full face mask  
Polycarbonate visor, waterproof  
motor, PAPR-P3 particulate filter,  
battery and user instructions.



3M Order Code	Model #	Description
AT019184095	902-02-12	Powerflow™ 6800 Plus Full Face Respirator Kit

For spare parts and accessories refer to the Part & Accessories Guide

### Filters

3M Order Code	Model #	Description
XP100544418	052670	DT-Series (Pro2000) DT-1135E PF10 P3

## 3M™ PF-600E-ASB (Proflow SC160) PAPR

- PF-600E-ASB (Proflow SC160) comes with blower unit, battery, recharger, hose with DIN thread and PVC belt
- Lightweight and compact
- Continuous visible monitor of battery status and filter blockage
- Audible alarm for low battery and filter clogging
- Typical 6-7 hours use for a single charge
- NiMH high power battery with fast recharge
- Shower-proof construction enhances decontamination
- Low through life running costs



### Proflow SC160 Ratings

Face Masks		
FF-300 (Promask/FM3) Full Face Mask	PAPR P3	PAPR B1E1K1P3
FF-600 (Vision RFF4000/FM4) Full Face Mask	PAPR P3	PAPR B1E1K1P3

3M Order Code	Model #	Description
XP100544624	064580	PF-600E-ASB (Proflow SC160) Green Power Pack (Filters not included)

For spare parts and accessories refer to the Part & Accessories Guide

# Powered Air Purifying Respirators

## 3M FF-300 (Promask Single/FM3) Full Facepiece

- Choice of halo-butyl elastomer and silicone face piece material
- Unique speech diaphragm that for clearer speech transmission
- Easy disinfection, decontamination and maintenance
- Wide sealing edge provide superior fit
- T-bar 5 point head harness for increased wearer comfort and fit
- Sweat port in chin pocket providing added comfort during extended wear times
- Quick release headband
- Slim-line design allows easy integration with helmets and earmuffs
- Wide sealing edge provide superior fit
- Available in two sizes
- Choice of PU fixed length or EPDM hose (purchased separately)
- Certified to AS/NZS 1716:2012 PAPR P3 with PF-600E-ASB (Proflow 160)
- Polycarbonate visor



3M Order Code	Model #	Description
XP100544079	012681/FF-302	3M FF-302 (Promask Single/FM3) PAPR full face mask (M/L), no hose (PAPR P3)
XP100547205	012670/FF-301	3M FF-301 (Promask Single/FM3) PAPR full face mask (S), no hose (PAPR P3)

For spare parts and accessories refer to the Part & Accessories Guide

## FF-600 (Vision RFF4000/FM4) Full Facepiece

- Non dermatitic silicone construction minimises risk of skin irritation
- Reverted edge face seal ensuring good fit and increased safety
- High efficiency speech diaphragm allows wearer to communicate clearly
- Available in two sizes
- Choice of PU fixed length or EPDM hose (purchased separately)
- Certified to AS/NZS 1716:2012 PAPR P3 with PF-600E-ASB (Proflow SC160)
- Polycarbonate visor



3M Order Code	Model #	Description
XP100544962	FF-603 (RFF4000)	3M FF-603 (RFF4000/FM4) Silicon PAPR Side mounted full face mask (M/L), no hose (PAPR P3)
XP100550118	FF-601 (RFF4000S)	3M FF-601 (RFF4000S/FM4) Silicon PAPR Side mounted full face mask (S), no hose (PAPR P3)

For spare parts and accessories refer to the Part & Accessories Guide

# Facepiece selection guide.

Industry	FF-300 (Promask/FM3)	FF-600 (Vision RFF4000/FM4)
Laboratories	■	■
Textiles	■	■
GRP Manufacture	■	■
Food Processing	■	
Flour Mills and Silos	■	■
Agriculture	■	■
Wineries/Market Gardens	■	■
Pest Control	■	■
Animal Allergies	■	■
DIY		
Pharmaceutical	■	■
Foundries	■	
Lead Processing	■	■
Aluminium Works		■
Steel Industry	■	
Shipyards	■	
Welding		
Tunnelling/Quarrying	■	
Mining	■	
Demolition & Maintenance	■	
Building & Construction	■	
Purification & Sewage	■	■
Waste Disposal	■	■
Chemical Plants	■	■
Petrochemical	■	■
Nuclear	■	■
Electronic/PCB Manufacture	■	■
Paint Spraying	■	■

# Powered Air Purifying Respirators

## 3M™ DT Series (Pro2000) Filters for PF-600E-ASB (Proflow SC160) Powered Air Purifying (PAPR) Units

- This selection of DT Series (Pro2000) filters are suitable for use with the PF-600E-ASB (Proflow SC160) PAPR
- Dependant on the headtop selection the ratings on the filters below may change
- The particulate rating on the filters may vary between P1 and P3
- DT-Series (Pro2000) filter canisters have a DIN 40mm thread connection



042799



052670

Filter Type	Colour	Main area of application
P	White	Particles: dusts, mists, fumes, fibres, toxic particles & microorganisms (bacteria, fungi, viruses, enzymes)
A	Brown	Organic gases and vapours with boiling point >65°C. eg. acid gases, toluene, xylene, mek, benzene, alcohols
B	Grey	Gases. eg. chlorine, hydrogen, sulphide
E	Yellow	Sulphur dioxide
K	Green	Ammonia and organic ammonia derivatives
Hg-P	Red-White	Mercury (vapour) and mercury compounds

3M Order Code	Model #	Description
XP100544418	052670/DT-1135E	DT-Series (Pro2000) PF10 P3
XP100544343	042799/DT-4045E	DT-Series (Pro2000) CF32 B1E1K1P3



## 3M™ PF-600E-ASB (Proflow SC160) PAPR Ready-Pak

- Ready-Pak comes with PF-600E-ASB (Proflow SC160) blower unit, battery, charger, EPDM hose, PVC belt, PAPR Respirator, two DT Series (Pro2000) PF10 particulate filters and two storage solutions; stackable tub or carry case
- Ready-Paks available with FF-300 (Promask FF), FF-600 (RFF4000 Vision FF) (side mounted filter connection)



XP100544731



XP100231594

3M Order Code	Model #	Description
XP100544731	5064594	FF-300 (Promask Single/FM3) PF-600E-ASB (Proflow SC160) Ready-Pak
XP100231594	5564593	FF-600 (Vision RFF4000) PF-600E-ASB (Proflow SC160)

### Proflow SC160 Hoses

3M Order Code	Model #	Description
XP100544541	063799	EPDM hose (angle & DIN) 80cm for use with FM3, FM4 (comes standard with PF-600E-ASB (SC160))
XP100231560	5564453/SC-BT-44	EPDM Rubber hose for use with FH1, FH2 and FH21
XP100140605	2026226/SC-BT-23	Fixed length PU for use with FH1, FH2 and FH21
XP100140639	2026231	Fixed length PU for use with FM3 and FM4

For spare parts and accessories refer to the Part & Accessories Guide



# Airline & Escape

Ideal for environments where ambient oxygen cannot be guaranteed, airline breathing apparatus combines the highest degree of respiratory protection with long duration use.

# Air Supplied Respirators.

There are commonly three types of air-supplied breathing apparatus which are each suited to different tasks;

- Airline breathing apparatus
- Escape breathing apparatus
- Self Contained Breathing Apparatus (SCBA)

**Airline breathing apparatus** are available as either constant flow airline or positive pressure demand airline system.

Constant flow airline apparatus is typically a combination of an airline face mask with a short air hose and also a filter. The short air hose connects to a control valve on a waist belt. The filter is used when entering and exiting the contaminated job. When a worker enters the contaminated work site they would plug the control valve on their waist belt to an air hose, which is connected to either an airline trolley with cylinders or other air supply.

Positive pressure airline apparatus includes a positive pressure full face mask and pneumatics with demand valve and a short hose on a bandolier style harness (optional hip mounted

escape cylinder is available). The pneumatics connects to the breathing air hose, which is connected to either an airline trolley with cylinders or other air supply. Positive pressure airline systems are particularly suited to confined space entry and are popular in the oil and gas industry for maintenance when entering into tanks and pipework.

Air cylinder trolley's are available with up to 4 cylinders supplying air for up to 4 employees. This system can offer infinite working duration as one cylinder can be changed whilst taking air from another cylinder.

**Escape Breathing Apparatus** also known as Emergency Life Support Apparatus are designed only for escape from hazardous conditions as they normally only include very short-duration compact air cylinders.

Scott offer the ELSA (Emergency Life Support Apparatus) with 15 minute duration cylinders. These products should **NOT** be used for normal working activities, entry to hazardous areas or rescue work.

## Constant Flow Airline range

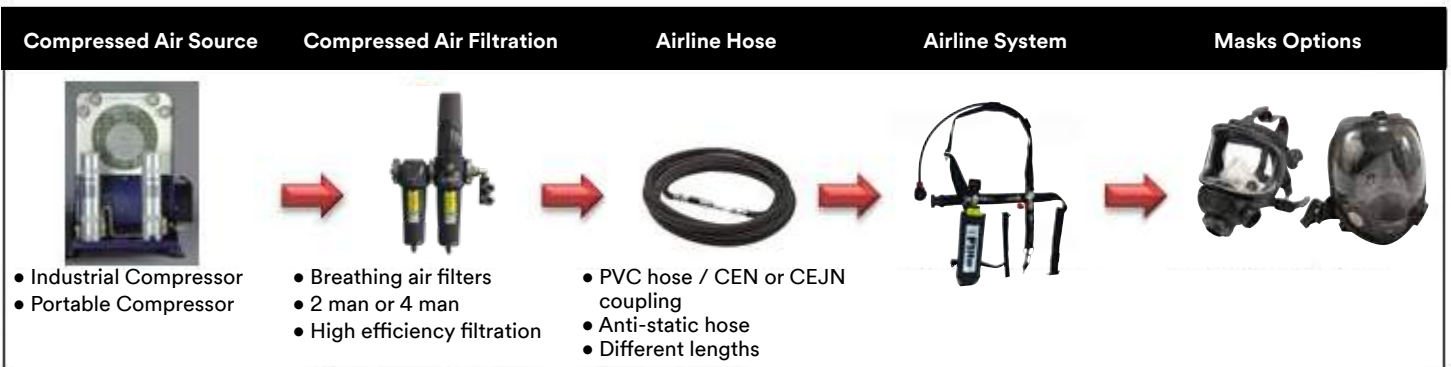

This range is designed to operate from an industrial compressed air system but other air sources like an airline trolley or cylinders are also suitable. Air is delivered to a facepiece via a breathing hose. Air flow is controlled by a belt mounted regulator or from the filtering unit depending on the facepiece. The flow rate is easily checked by using the flowmeter. A compressed air supply hose connects the wearer to a source of compressed air.

# 3M™ Versaflo™ Supplied Air Respirator V-500E & Kit

Versaflo™ Supplied Air Regulator Kit, V-500E includes air regulator with locking adjustment knob and integrated low air flow warning whistle, silencer, replacement carbon filter, auxillary port and user instructions. Suits the range of M Series and S Series Versaflow headtops.



902-03-84

3M Order Code	Model #	Description
XA007706675	V-500E	Supplied Air Regulator (Excludes breathing tube). Suits the range of M Series and S Series Versaflo headtops tote bin
AT010587783	902-03-84	Versaflo™ Spray Painter Kit, ALVM-206E c/w V-500 supplied air regulator, BT30 breathing tube and M-206 headtop tote bin

For spare parts and accessories refer to the Part & Accessories Guide

# Airline & Escape

## V-100 Vortex Cooling Airline Belt System

Cooling Airline Kit includes Cooling Vortex Kit, V-100, muffler, hose connector, BT-30 adjustable breathing tube, waist belt and user instructions. Suits the range of M Series and S Series Versaflow headtops.



AT019167983

3M Order Code	Model #	Description
AT019184244	902-02-18	Cooling Airline Kit with adjustable Breathing Tube

For spare parts and accessories refer to the Part & Accessories Guide

## 3M™ Scott Breathing Air Filters

- Designed to be installed directly at the point of use, breathing air filters combine two types of filtration into one housing
- Liquid aerosols and solid particulates are removed using a pleated filter
- Oil vapours are removed by an activated carbon filter
- Each breathing filter ensures low pressure loss
- Filter regulator available to suit 2 man or 4 man capacity



3M Order Code	Model #	Description
XP100141249	2026772	AFU-4-MAN Four man airline filter unit

For spare parts and accessories refer to the Part & Accessories Guide

## V-200 Vortex Heating Airline Belt System

Heating Airline Kit includes Heating Vortex kit, V-200, muffler, hose connector, waist belt and user instructions. Suits the range of M Series and S Series Versaflow headtops.



3M Order Code	Model #	Description
AT010589466	902-02-85	Heating Airline Kit with Breathing Tube

For spare parts and accessories refer to the Part & Accessories Guide

## V-300 Standard Airline Kit

Standard Airline Kit includes Standard Airline Regulator, V-300, muffler, hose connector, belt and instructions. Suits the range of M Series and S Series Versaflow headtops.



902-02-17

3M Order Code	Model #	Description
AT019184236	902-02-17	Standard Airline Kit with BT-30 Breathing Tube

For spare parts and accessories refer to the Part & Accessories Guide

## Stethoscope Breathing Tube Sets



901-00-71

3M Order Code	Model #	Description
AT019202897	902-03-15	SA-2100 Combination Dual Airline complete with CEJN Fitting and SA-1007 valve regulator. Capability of fitting negative pressure filters as well as positive pressure airline protection

For spare parts and accessories refer to the Part & Accessories Guide



# Airline & Escape

## 3M™ Scott Flite COV Airline Breathing Apparatus - COMING

- Easy to don bandolier harness with padded shoulder strap
- Optional 10 or 15 minute air supply for emergency escape from hazard situations, must be worn in IDLH
- Can be used with Scott range of positive pressure masks (sold separately)
- If primary air supply source is interrupted a switchover to emergency cylinder air supply is immediately activated by the automatic change over valve to facilitate safe egress
- Warning whistle informs user switch has been made to cylinder air



3M Order Code	Model #	Description
XP100148376	2031077	Flite COV Airline Breathing Apparatus DV CEN
XP100544202	013190	Promask PP Left Quick Fit Full Face Mask
XP100071271	1071671	Vision 3 PP Left Quick Fit Full Face Mask
XP100148707	2031535	200 bar 10 min steel cyl c/w pouch and reducer/hose Full
XP100148822	2031603	Spare cylinder pouch CYL-FLITE-10
XP100116761	2010722	Flite fast fill adaptor
XP100067089	084.059.01	Breathing apparatus log book Ind
XP100067428	089.386.00	Testkit and toolkit
XP100101664	018.008.99	Charge adaptor handwheel liner 207 Bar
XP100058286	010.125.00	Flite storage/carrying case

## Airline Breathable Air Hoses - CEJN Fittings



3M Order Code	Model #	Description
AT019165698	901-00-54	Breathing Hose 15m - CEJN

## 3M™ Scott Airline Hoses

- Made from durable PVC
- Anti-static hoses available on request
- CEN double action couplings



3M Order Code	Model #	Description
XP100069127	1051463	10 Mtr Black PVC Hose With CEN Couplings
XP100069143	1051467	20 Mtr Black PVC Hose With CEN Couplings
XP100069168	1051471	30 Mtr Black PVC Hose With CEN Couplings
XP100069200	1051477	50 Mtr Black PVC Hose With CEN Couplings
XP100100336	2003397	Y Piece With CEN Couplings
XP100060530	1023353	Inline Whistle With CEN Couplings
XP100069333	1051526	High Pressure Reducer Whistle PIN
XP100069341	1051528	High Pressure Reducer DIN 300 Bar
AT010700477	RXMCT	Airline Fitting Female With Male Thread
XP100069234	1051482	10m Hose Airline Antistatic With Stripe
XP100069259	1051486	20m Hose Airline Antistatic With Stripe
XP100069267	1051488	30m Hose Airline Antistatic With Stripe
XP100069283	1051493	50m Hose Airline Antistatic With Stripe

## 3M™ Scott Modulair Airline Trolley

- Compact, easy to use airline trolley system
- Capacity to hold 2 cylinders for 2 man operation or to hold 4 cylinders for 4 man operation
- Suitable for ships, councils, sewage treatment, refineries, mining, confined space entry and extended duration use



3M Order Code	Model #	Description
XP100069671	1051844	Modulair Trolley With Hose Reel 2P 2Cyl
XP100069812	1051880	Modulair Trolley With Hose Reel 4P 4Cyl
XP100069861	1051945	Modulair 2 Person 2 Cylinder
XP100069846	1051902	Modulair Hose Reel Only
NT070008692	1127413TNZ	Cylinders 9L 300 Bar Carbon Fibre T valve
XP100069143	1051467	20 Mtr Black PVC Hose With CEN Couplings

# 3M™ Scott ELSA® Escape Breathing Set

The 3M™ Scott ELSA constant flow breathing apparatus is an escape breathing apparatus which provides a constant supply of air for rapid escape from hazardous industrial and marine environments. The ELSA is simple and quick to operate, reliable and robust in use, ensuring maximum protection in an escape situation. The ELSA supplies 15 minutes of air. The ELSA apparatus consists of a cylinder with combined cylinder valve and reducer, supply hose to constant flow hood and storage bag. The ELSA is activated upon opening the bag whereby a pin which is attached to the bag via a strap is released.

### Features and Benefits:

- ELSA Escape Breathing Set with 15 minute air cylinder
- Adjustable shoulder strap for carrying convenience
- Automatic activation upon opening the carry bag - delivers constant flow of air
- Integrated warning whistle on low air condition
- Easily rechargeable and reusable
- Cubic hood design allows wearing by users with beards or eye glasses



3M Order Code	Model #	Description
AT010782012	2009419	ELSA 15 Minute Escape Set With Cylinder (empty)



# Self Contained Breathing Apparatus

Self Contained Breathing Apparatus (SCBA) can be configured in a number of different ways with various size & capacity cylinders, facepieces and back plates. Our SCBA's are ergonomically designed for comfort and mobility, combined with the highest standards of performance and safety.

# Self Contained Breathing Apparatus (SCBA).

An SCBA is similar to SCUBA sets, but are not designed for use in water. Like SCUBA, they consist of a carrying harness, pneumatic hoses, remaining air-time gauge, cylinder retaining back-plate and a facemask. There are versions available with various levels of harness adjustment and padding. Premium level SCBA's are also available with height adjustability to better suit people of different heights.

Part of the SCBA family are jacket-style SCBA sets that are quick and easy to don (put on), being designed as a quick snatch-rescue set, ideal for use in correctional services or the oil and gas industry.

### SCBA Variants:

There are also a range of SCBA variants available including Airline (AC), Split Demand Valve Coupling (SDC or Y2C), Quick Connect Option, fast fill or Duo variants. The SCBA variant selected is depending on the users need and job requirements.

Air-supplied respiratory systems require the use of a Positive Pressure full-face mask. Masks are available in different materials, shapes and sizes to best suit individual wearers and the task at hand.

SCBA sets are offered with different types/sizes of cylinders for containing and carrying clean compressed breathing air. Nowadays the most common cylinders used are lightweight carbon composite cylinders.

### Common SCBA cylinder sizes:

- 6.8 Litre capacity at 300 Bar cylinder pressure, offering approximately 45 minutes air duration
- 9 Litre capacity at 300 Bar cylinder pressure, offering approximately 60 minutes air duration



# Self Contained Breathing Apparatus

## 3M™ Scott ProPak-fx T2 SCBA

The 3M™ Scott ProPak-Fx is a Type 2 open circuit, self-contained, compressed air breathing apparatus. It consists of a back plate, padded carrying harness and pneumatic system, containing a cylinder connector, reducer, pressure gauge, whistle and demand valve.

The ProPak-Fx can be configured in a number of different ways with various size single cylinders. There are also a range of variants available including Airline (AC), Split Demand Valve Coupling (SDC or Y2C), Quick Connect Option or Duo variants. The ProPak-Fx is used in conjunction with either Promask PP or Vision 3 PP face mask and a choice of composite or steel cylinders.

Specifically designed as a professional fire fighting SCBA, the ProPak-Fx is also suitable for providing respiratory protection in any IDLH environment.

ProPak-Fx also offers a Pivot and height adjustable waist belt for increased wearer comfort to suit most people.

### Features and Benefits:

- Designed for use by the Fire Service
- Rigid backframe construction
- Easily removable pneumatics
- Cost effective to service and maintain
- Adjustable padded shoulder straps
- Kevlar & Pyrogard blend wrap around harness
- Side arms for increased user comfort
- Reflective webbing
- Pivot and height adjustable waist belt for increased wearer comfort
- Certified to AS/NZS 1716:2012 and EN137:2006 Type 2 MED



3M Order Code	Model #	Description
XP100142312	2027195	SCBA Propak-Fx
XP100142338	2027197	SCBA Propak-Fx-SDC T2
AT010663683	2027196	SCBA ProPak-fx-AC-T2
XP100544202	013190	Promask PP Left Quick Fit Full Face Mask
XP100071271	1071671	Vision 3 PP Left Quick Fit Full Face Mask
XP100215092	5013175	Promask PP LQF Small HC STD
AT010787961	1127413RAVNZ	Cylinders 9L 300 Bar Carbon Fibre RAV
AT010645821	2014810	SCBA Moulded Carry Case

# Self Contained Breathing Apparatus

## 3M™ Scott Sigma 2 T2 SCBA

- Designed for marine, industrial, confined space entry, rescue or industrial firefighting
- Proven high performance pneumatic system
- Compact first breath activated demand valve with bypass
- Ergonomically designed lightweight backplate and type 2 harness
- Kevlar blend flame retardant webbing with Kevlar cylinder band
- Certified to AS/NZS 1716:2012 and EN137:2006 Type 2 MED



3M Order Code	Model #	Description
XP100136348	2023034	SCBA Sigma 2 T2 Compliance set
XP100544202	013190	Promask PP Left Quick Fit Full Face Mask
XP100071271	1071671	Vision 3 PP Left Quick Fit Full Face Mask
XP100215092	5013175	Promask PP LQF Small HC STD
NT070008692	1127413TNZ	Cylinders 9L 300 Bar Carbon Fibre T valve
AT010645821	2014810	SCBA Moulded Carry Case

## 3M™ Scott Propak Classic Type 2 SCBA

- Designed for use in various professional fire fighting and industrial applications
- Ergonomically designed, strong, lightweight, moulded back plate
- 100% Kevlar padded webbing harness
- Harness intrinsically flame retardant 50% Kevlar blend webbing and Nomex 3 fabric
- Optional airline and decontamination attachments
- Mask & cylinders purchased separately
- Certified to AS/NZS 1716:2012 and EN137:1998 Type 2



3M Order Code	Model #	Description
XP100123395	2015294	Propak SCBA - backplate, harness & pneumatics
XP100125234	2016154	ProPak-Duo-AC-F
XP100071271	1071671	Vision 3 PP Left Quick Fit Full Face Mask
XP100544202	013190	Promask PP Left Quick Fit Full Face Mask
XP100215092	5013175	Promask PP LQF Small HC STD
NT070008692	1127413TNZ	Cylinders 9L 300 Bar Carbon Fibre T valve
XP100069903	1051962	MAN-300 Manifold ASSY 300 BAR

## 3M™ Scott ProPak Sigma T2 SCBA

- Designed specifically for use as a compliance set in Marine or Industrial fire fighting environments
- Rigid backframe construction
- Easily removable pneumatics
- Cost effective to service and maintain
- Certified to AS/NZS 1716:2012 and EN137:2006 Type 2 MED



3M Order Code	Model #	Description
XP100141959	2027150	SCBA Promask Sigma T2
AT010695230	2027152	SCBA ProPak-Sigma-AC T2
XP100544202	013190	Promask PP Left Quick Fit Full Face Mask
XP100071271	1071671	Vision 3 PP Left Quick Fit Full Face Mask
XP100215092	5013175	Promask PP LQF Small HC STD
AT010787961	1127413RAVNZ	Cylinder 9L 300 Bar Carbon Fibre RAV
AT010645821	2014810	SCBA Moulded Carry Case

## 3M™ Scott ProPak-i T2 SCBA

- Designed for use by the fire service or the oil & gas market and industrial, confined space industry.
- Rigid backframe construction
- Easily removable pneumatics
- Cost effective to service and maintain
- Kevlar blend wrap around harness
- Side arms for increased user comfort
- Certified to AS/NZS 1716:2012 and EN137:2006 Type 2 MED



3M Order Code	Model #	Description
XP100142049	2027166	SCBA Propak-I T2 Industrial
AT010663915	2027167	SCBA ProPak-I-AC-T2 with airline
XP100142114	2027174	SCBA ProPak-I with fast fill
XP100544202	013190	Promask PP Left Quick Fit Full Face Mask
XP100071271	1071671	Vision 3 PP Left Quick Fit Full Face Mask
XP100215092	5013175	Promask PP LQF Small HC STD
AT010787961	1127413RAVNZ	Cylinders 9L 300 Bar Carbon Fibre RAV
AT010645821	2014810	SCBA Moulded Carry Case

## 3M™ Scott ProPak-f T2 SCBA

- Designed for use by the Fire Service or the Oil & Gas market
- Rigid backframe construction
- Easily removable pneumatics
- Cost effective to service and maintain
- Adjustable padded shoulder straps
- Kevlar & Pyrogard blend wrap around harness
- Side arms for increased user comfort
- Reflective webbing
- Certified to AS/NZS 1716:2012 and EN137:2006 Type 2 MED



3M Order Code	Model #	Description
XP100142189	2027182	SCBA Propak-F T2
XP100142205	2027184	SCBA Propak-F-SDC T2
XP100142254	2027189	SCBA ProPak-f with fast fill
AT010663402	2027183	SCBA ProPak-f-AC T2 with airline
XP100544202	013190	Promask PP Left Quick Fit Full Face Mask
XP100071271	1071671	Vision 3 PP Left Quick Fit Full Face Mask
XP100215092	5013175	Promask PP LQF Small HC STD
AT010787961	1127413RAVNZ	Cylinders 9L 300 Bar Carbon Fibre RAV
AT010645821	2014810	SCBA Moulded Carry Case

# Self Contained Breathing Apparatus

## 3M™ Scott ProPak-f-Ez-Flo T2 SCBA

- Designed for use by the Fire Service or the Oil & Gas market
- Certified with AV3000HT PP Full Face mask or Scott Sight TIM (Thermal Imaging in Mask) with Ez-Flo Demand Valve
- Rigid backframe construction
- Easily removable pneumatics
- Cost effective to service and maintain
- Adjustable padded shoulder straps
- Kevlar & Pyrogard blend wrap around harness
- Side arms for increased user comfort
- Reflective webbing
- Certified to AS/NZS 1716:2012 and EN137:2006 Type 2



\*see mask section for other sizes and comms masks)

## 3M™ Scott ProPak-fx-Ez-Flo T2 SCBA

- Designed for use by the Fire Service
- Certified with AV3000HT PP Full Face mask or Scott Sight TIM (Thermal Imaging in Mask) with Ez-Flo Demand Valve
- Rigid backframe construction with adjustable backplate
- Easily removable pneumatics
- Cost effective to service and maintain
- Adjustable padded shoulder straps
- Kevlar & Pyrogard blend wrap around harness
- Side arms for increased user comfort
- Reflective webbing
- Pivot and height adjustable waist belt for increased wearer comfort
- Certified to AS/NZS 1716:2012 and EN137:2006 Type 2



3M Order Code	Model #	Description
XP100149531	2031958	PROPAK-F-EZ-Flo (V2)
XP100149549	2031960	ProPak-f-Ez-flo-AC with airline
XP100149556	2031961	PROPAK-F-EZ-Flo-SDC Split Demand Valve Coupling CEN
XP100293917	8005243	AV3000HT Medium Face Mask
AT010787961	1127413RAVNZ	Cylinders 9L 300 Bar Carbon Fibre RAV
AT010645821	2014810	SCBA Moulded Carry Case
XP100293107	8004794	Ez-Flo With SDC Hose

3M Order Code	Model #	Description
XP100149622	2031988	Propak-Fx-Ez-Flo
XP100149648	2031991	Propak-Fx-Ez-Flo-SDC W Split Demand Valve
XP100149630	2031990	ProPak-fx-Ez-flo-AC with airline
XP100293917	8005243	AV3000HT M Face Mask
AT010787961	1127413RAVNZ	Cylinders 9L 300 Bar Carbon Fibre RAV
AT010645821	2014810	SCBA Moulded Carry Case
XP100293107	8004794	Ez-Flo With SDC Hose

## 3M™ Scott Contour 100 SCBA

- Designed for use in various industrial applications
- Ergonomically designed, strong, lightweight, moulded back plate
- First breath demand valve
- Kevlar blend non-padded web harness
- Optional airline and fast fill decontamination attachments
- Mask & cylinders purchased separately
- Certified to AS/NZS 1716:2012 and EN137:1998 Type 1



3M Order Code	Model #	Description
XP100110095	2009236	CTR-100 DUO with Fast Fill
XP100069903	1051962	MAN-300 Manifold Assy 300 Bar
XP100111432	2009536	CTR-100 SINGLE + Fast Fill
XP100138989	2025187	CTR-100 + Fast Fill SCBA
XP100138997	2025188	CTR-130 + Fast Fill + RSM SCBA
XP100544202	013190	Promask PP Left Quick Fit Full Face Mask
XP100071271	1071671	Vision 3 PP Left Quick Fit Full Face Mask
NT070008692	1127413TNZ	Cylinders 9L 300 Bar Carbon Fibre T valve
AT010645821	2014810	SCBA Moulded Carry Case

## 3M™ Scott Contour 300 SCBA

- Designed for use in various industrial applications
- Ergonomically designed, strong, lightweight, moulded back plate
- 100% Kevlar padded webbing harness
- Flame retardant webbing with Kevlar cylinder band
- Optional airline and decontamination attachments
- Mask & cylinders purchased separately
- Certified to AS/NZS 1716:2012 and EN137:1998 Type 1



3M Order Code	Model #	Description
XP100128295	2017794	CTR-300-F-Y C/W Promask PP
XP100544202	013190	Promask PP Left Quick Fit Full Face Mask
XP100071271	1071671	Vision 3 PP Left Quick Fit Full Face Mask
NT070008692	1127413TNZ	Cylinders 9L 300 Bar Carbon Fibre T valve
AT010645821	2014810	SCBA Moulded Carry Case

## Self Contained Breathing Apparatus

# 3M™ Scott Promask PP LQF Full Face Mask

### Features and Benefits:

- Accommodates a wide range of facial shapes and sizes
- Positive pressure mask made from Halo Butyl rubber Procomp™ non-irritating material with reflex seal and TPE (Thermo Plastic Elastomer) oronasal inner mask
- The face piece visor features a single plane curvature to minimise reflection and is made of a scratch and impact resistant polycarbonate material with a flame-retardant coating that provides excellent panoramic vision
- Available with optional prescription lens insert for spectacle wearers
- Left side demand valve connection for unobstructed field of vision
- Front mounted speech diaphragm offers unimpeded speech transmission
- Certified to AS/NZS 1716:2012



3M Order Code	Model #	Description
XP100544202	013190	Promask PP Left Quick Fit Full Face Mask
XP100547379	013192	Promask PP REQF LQF
XP100149945	2032231	Promask PP LQF HC EPIC 3 M L Rubber Head Harness
XP100548815	2032232	Promask PP LQF HC EPIC 3 Sml Rubber Head Harness
XP100215068	5013166	Promask PP LQF RAS MI HC Std
XP100095122	2001703	Blank Plug REQF
XP100546108	012692	Rubber Head Harness (2)
XP100547270	012775	Webbing Head Harness Promask Suit M98



# Self Contained Breathing Apparatus

## 3M™ Scott Vision 3 PP Full Face Mask

- Left Quick Fit demand valve connection
- Rubber and net head harness options
- Non-dermatitic liquid silicone outer mask
- Hemispherical visor provides excellent field of vision
- TPE inner mask
- Hard coated anti-scratch visor
- Excellent speech transmission
- Voice amplifier and radio comms available
- Variety of sizes for improved fit
- Certified to AS/NZS 1716:2012



3M Order Code	Model #	Description
XP100071271	1071671	Vision 3 LQF Facemask Std Harness
XP100095239	2001746	Vision 3 LEQF RAS RDIN M L Full Face Mask
XP100106671	2008699	Vision 3 LQF REQF Facemask
XP100149911	2032227	Vision PP LQF HC EPIC 3 M L Rubber Head Harness
XP100149929	2032228	Vision PP LQF HC EPIC 3 Sml Rubber Head Harness
XP100065943	1033400	Vision 3 NET Head Harness
XP100095122	2001703	Blank Plug REQF

## 3M™ Scott AV3000HT PP Full Face Mask

- High performance anti-fog lens for improved thermal performance
- Proven SureSeal reflex faceseal for excellent fit and comfort
- Designed to accept front fitting EZ-Flo demand valve
- Right or left EPIC 3 communications bracket for maximum versatility
- Speech diaphragm on both sides for improved voice transmission
- 5 Point Kevlar head harness with neck strap suitable for Fire & CBRN applications
- Thermal performance passes NFPA heat requirement of 15Kw/M2
- Available in 3 sizes
- Certified to AS/NZS 1716:2012, EN136 Class 3 with ProPak-f and ProPak-fx



3M Order Code	Model #	Description
XP100293909	8005242	AV3000HT S Face Mask
XP100293917	8005243	AV3000HT M Face Mask
XP100293925	8005244	AV3000HT L Face Mask
XP100293933	8005245	AV3000HT RECB Small Kevlar Face Mask
XP100293941	8005246	AV3000HT RECB Med Kevlar Face Mask
XP100293958	8005247	AV3000HT RECB Large Kevlar Face Mask
XP100293966	8005248	AV3000HT LECB Small Kevlar Face Mask
XP100293974	8005249	AV3000HT LECB Med Kevlar Face Mask
XP100293982	8005250	AV3000HT LECB Large Kevlar Face Mask

## 3M™ Scott Sight Pro Hands Free Thermal In-Mask Imaging System

- **Hot-spot tracker** - Immediately identify the hottest part of the scene and display its relative temperature. Ideal for overhaul, search and rescue, and risk assessment
- **Cold-spot tracker** - Immediately identify the coldest part of the scene and display its relative temperature. Ideal for hazmat environments
- **Tactical Video Recording (TVR)** - Automatically record all the information shown on the IMD for review later.
- Mask integrated lightweight thermal camera and display
- Hands free thermal vision system enables firefighter to work more efficiently and safely
- Enhanced situational awareness with improved hot zone accountability
- Powerful and lightweight at only 240 grams
- 160 x 120 pixel resolution at 9 frames per second display
- Adjustable display angle configurable to line-of-sight
- Minimum four-hour battery life – powered by 5 x regular AAA batteries
- Spot or ambient temperature settings (Fahrenheit or Celsius)
- User configurable screen options
- Electronics certified to ATEX/IECX and IP 66/67
- Mask certified to AS/NZS 1716:2012
- Optional Left-Side comms bracket for EPIC 3 voice amp



3M Order Code	Model #	Description
AT010788225	8007317	3M™ Scott™ Sight Pro AV3000HT SML
78008249704	8007318	3M™ Scott™ Sight Pro AV3000HT MED
78008249571	8007319	3M™ Scott™ Sight Pro AV3000HT LRG
XP100852233	8007320	3M™ Scott™ Sight Pro AV3000HT ECB SML
78008249597	8007321	3M™ Scott™ Sight Pro AV3000HT ECB MED
78008249605	8007322	3M™ Scott™ Sight Pro AV3000HT ECB LRG

# Self Contained Breathing Apparatus

## 3M™ EPIC Lapel Speaker Microphone

- Rugged Lapel Speaker Microphone (LSM) option for users without an OEM LSM
- Works well with EPIC 3 Voice Amplifier
- Provides clear communication
- Supports EPIC wired accessories
- Front microphone and speaker for Remote Speaker Mic operation
- Top mounted Emergency Notification button for use with select field radios
- Durable IP66/67 rated system for use in demanding high temperature environments
- 50 hours of battery life with Alkaline AAA batteries



## 3M™ Scott EPIC 3 Bluetooth® Lapel Speaker Microphone

- Supports wireless communications between EPIC 3 RI Voice Amplifier and remote speaker microphone operation with two-way field radios
- Provides seamless tactical and non-tactical communication capabilities
- Also offers connectivity with EPIC 3 - communication accessories



3M Order Code	Model #	Description
XP100119757	201224-02	EPIC 3 Lapel SM Motorola HT1000, XTS Series Radios
XP100546314	201224-04	EPIC 3 Lapel SM Motorola HT750/1250/1550 Series Radios
XP100119765	201224-06	EPIC 3 Lapel SM Motorola MOTOTRBO XPR, APX Series Radios
XP100119773	201224-07	EPIC 3 Lapel SM Kenwood TK280/290/380/390 Series Radios
XP100119781	201224-22	EPIC 3 Lapel SM Harris P5400/7300, Unity, XG Series Radios

3M Order Code	Model #	Description
XP100119989	201277-06	EPIC 3 Bluetooth Lapel Sm Motorola Mototrbo XPR, APX Series Radios
XP100120003	201277-11	EPIC 3 Bluetooth Lapel Sm Motorola
XP100119963	201277-02	EPIC 3 Bluetooth Lapel Sm Motorola HT1000, XTS Series Radios, GP300 Series Radios
XP100119971	201277-04	EPIC 3 Bluetooth Lapel Sm Motorola HT750/1250/1550 Series Radios
XP100119997	201277-07	EPIC 3 Bluetooth Lapel Sm Kenwood TK280/290/380/390 Series Radios
XP100120011	201277-22	EPIC 2 Bluetooth Lapel Sm Harris P5400/7300, Unity, XG Series Radios

## EPIC related questions:

1. Is only voice amp needed?
2. What Radio is used?
3. Is the Radio used Bluetooth capable?
4. If so is a Lapel/Push to Talk (PTT) needed?
5. How many of each is needed?
6. What type of mask is needed, Promask, Vision or AV3000HT (only used on ProPak-f/fx-Eze Flo)?

**\*Please note existing Promask/Vision and Vision AMS are not able to be upgraded to add Epic comms port, customers will need to purchase a new mask that has Epic comms bracket fitted.**



# Self Contained Breathing Apparatus

## 3M™ Scott EPIC 3 Voice Amplifier

- Compact, high performance voice amplifier
- Automatic Shutoff reduces costs of battery replacement
- Intrinsically safe for use with alkaline and NiMH AAA batteries
- IP66/IP67 rated design is robust enough to withstand the most extreme applications
- Tactile On/Off button makes it easy to activate with gloved hands
- Angled directional speaker projects amplified voice forwards
- Compatible with Promask, Vision 3 and AV3000 positive pressure facemasks (with comms bracket)
- ATEX/IECEX certifications: Ex ia IIB T3 Ga IP66/67 Complies with IEC standards IEC 60079-0: 2007-10 Edition 5; and IEC 60079-11: 2011 Edition 6.0



3M Order Code	Model #	Description
XP100119872	201275-03	EPIC 3 Voice AMP to suit Vision Face Piece
XP100551637	201275-04	EPIC 3 Voice AMP to suit Promask Face Piece
XP100119849	201275-01	EPIC 3 Voice Amp Open Bracket AV3000HT

## 3M™ Scott EPIC 3 Radio Interface Voice Amplifier

- Compact, SCBA mask mounted voice amplifier and wireless radio communications device
- Enhances SCBA facepiece voice communication intelligibility and loudness
- Advances safety through easy-to-use wireless communication interoperability with mobile field radios (requires use of Scott EPIC Lapel Speaker Mic to suit field radio)
- Improves user communications from the incident scene to remote locations via field radio
- IP66 and IP67 rated design is robust enough to withstand the most extreme applications
- Tactile On/Off button makes it easy to activate with gloved hands
- Angled directional speaker projects amplified voice forwards
- Advanced electronic noise suppression technology improves communication clarity and personnel safety
- Compatible with Promask, Vision 3 & AV3000 facemasks (with comms bracket)



3M Order Code	Model #	Description
XP100119906	201276-03	EPIC 3 Radio Int Voice Amp Vision Face mask
XP100119914	201276-04	EPIC 3 Radio Int Voice Amp Promask Face mask
XP100119880	201276-01	EPIC 3 Radio Int Voice Amp Open Bracket AV3000HT

## 3M™ Scott EPIC 3 Radio Direct Interface (RDI) Voice Amplifier

- Compact, SCBA mask mounted voice amp and wireless radio-direct communications device
- Designed to work with encrypted Bluetooth® enabled Motorola APX digital radios direct from SCBA mask to radio
- Advanced electronic noise suppression technology improves communication clarity and personnel safety
- Durable IP66/67 rated system for use in demanding high temperature environments
- Tactile On/Off button makes it easy to activate with gloved hands
- Angled directional speaker projects amplified voice forwards
- Customisable, user friendly, easy to operate, system
- Compatible with Promask, Vision 3 & AV3000 facemasks (with comms bracket)



### EPIC 3 Radio Direct Interface Voice Amplifier

3M Order Code	Model #	Description
XP100119948	201276-13	EPIC 3 Radio Direct Int Voice Amp Vision
XP100119955	201276-14	EPIC 3 Radio Direct Int Voice Amp Promask

### EPIC 3 Full face masks with comms bracket

3M Order Code	Model #	Description
XP100149945	2032231	Promask PP LQF HC EPIC 3 M L Rubber Head harness
XP100548815	2032232	Promask PP LQF HC EPIC 3 Sml Rubber Head harness
XP100149911	2032227	Vision PP LQF HC EPIC 3 M L Rubber Head harness
XP100149929	2032228	Vision PP LQF HC EPIC 3 Sml Rubber Head harness
XP100119922	201276-11	EPIC 3 Radio Direct Int. Voice Amp Open Bracket AV3000HT
XP100293933	8005245	AV3000HT RECB Small Kevlar
XP100293941	8005246	AV3000HT RECB Med Kevlar
XP100293958	8005247	AV3000HT RECB Large Kevlar
XP100293966	8005248	AV3000HT LECB Small Kevlar
XP100293974	8005249	AV3000HT LECB Med Kevlar
XP100293982	8005250	AV3000HT LECB Large Kevlar

## 3M™ EPIC 3 Accessories

Specialised communication accessories that extend EPIC 3 utility include; command headset, throat microphone with earpiece, remote finger-mounted ring PTT control and remote PTT paddle device



3M Order Code	Model #	Description
XP100119799	201226-01	EPIC 3 Ring PTT
XP100119807	201227-01	EPIC 3 Paddle PTT
XP100119815	201228-01	EPIC 3 Throat MIC
XP100119823	201229-01	EPIC 3 Command COM Headset
XP100119831	201243-01	EPIC 3 Bluetooth Programmer Interface Module W/USB Cable
XP100104031	200715-01	EPIC 3 AV3000 COMMS Bracket Right

# Self Contained Breathing Apparatus

## 3M™ Scott Steel Cylinders

- Suitable for Scott SCBA and Scott Modulair Airline Trolley
- Complete with safety locking hand wheel



3M Order Code	Model #	Description
XP100148707	2031535	Flite COV 200 bar 10 min steel cyl c/w pouch and reducer/hose Full

## 3M™ SCBA Storage Solutions

- Large enough to carry SCBA, cylinder and mask



3M Order Code	Model #	Description
AT010658097	SCBABAG:L	Carry Bag Large SCBA 35Cm X 75Cm X 35Cm
AT010645821	2014810	SCBA Moulded Carry Case

## 3M™ Scott Trigene Solution & Wipes

- Antimicrobial respirator and surface wipes
- Available as ready-to-use wipes & pre-mixed solution or in concentrate form for dilution on-site
- TGA Registered - ARTG No: 232937 & 233129



3M Order Code	Model #	Description
AT010788142		Trigene Wipes Drum (180)
AT010648684	2008248EA	Trigene Solution 5L Concentrat Clear
AT010659616	TRIG:31	Trigene Pre-Mix 1 To 100 5L Green

## 3M™ Scott Carbon Fibre Cylinders

- Suitable for Scott SCBA and Scott Modulair Airline Trolley
- Constructed of an aluminium alloy inner shell overwrapped with carbon-fibre, fibreglass and epoxy resin
- Cylinder liner is coated with aluminium oxide to protect against moisture and corrosion
- Available with right angle valve (RAV) or T Valve 6.8L 300 Bar
- Supplied empty.



3M Order Code	Model #	Description
AT010787961	1127413RAVNZ	Cylinders 9L 300 Bar Carbon Fibre RAV
NT070008692	1127413TNZ	Cylinders 9L 300 Bar Carbon Fibre T valve
XP100060209	1023116	035.016.03 Pressure Test Gauge 200 300 Bar
XP100061173	1024182	038.249.00 Cylinder Protective Cover Red
XP100061181	1024185	038.250.00 Cylinder Protective Cover Red
AT010648692	200952-03	Cylinder Sleeve 45 min 4500 6.8L
AT010648700	200952-04	Cylinder Sleeve 60 min 4500 9L

## 3M™ Scott SCBA Wall Cabinet

- Universal breathing apparatus wall-mount cabinet
- Made from 3mm PVC reinforced with fibreglass
- Comes with clear plastic lid to protect SCBA from dust and dirt



3M Order Code	Model #	Description
AT010658113	SCBACAB	SCBA Wall Cabinet
AT010656182	QTB454	Wall Bracket SCBA



Science.  
Applied to Life.™



# Hearing Protection

Hearing protection must be right for you and your situation. For safety, productivity and comfort, it must reduce noise by the right amount, not too little and not too much. 3M can provide solutions for different individuals and applications with a wide range of earmuffs and earplugs.

[#3MScienceOfSafety](#)

# The solution, protection and validation.

As a global leader in sound and noise detection, hearing protection and fit test validation, 3M delivers easy and comprehensive solutions to complex hearing protection challenges.

Ears come in a variety of sizes and shapes, and noise levels on the job vary depending on the work that is being done. Hearing protection solutions by 3M offer a wide range of shapes and sizes to fit workers' ears comfortably while offering protection for a wide range of noise levels.

### Noise Detection

The first step in solving the hearing protection challenge is to measure the noise levels facing your workers, so you can select the appropriate hearing protection for the application.

### Adaptable Hearing Protection

3M delivers a wide range of innovative hearing protectors, making it easy to select the right solution for the job. A variety of types and sizes of earplugs and earmuffs are available helping your team determine the right fit for each person and the right protection for the application. Our innovative products are designed for comfortable, extended wear, and they can help your team comply with your safety program.

### Fit Test Validation

Integrating hearing protector fit testing into your hearing conservation program benefits everyone from new hires to high-risk workers. The 3M™ E-A-Rfit™ Validation System makes it easier to fit, train and motivate workers and to assess and manage the long-term performance of your hearing conservation program.

3M's broad range of hearing protection devices in a variety of types and styles helps you solve many of the challenges facing workers in various environments.

You can advance your hearing conservation programme with a customised and comprehensive approach to the hearing protection challenge. Implementing a solution that really makes a difference, begins with understanding the hazards, the regulation and the factors that impact protection.

# Understanding sound level conversion (SLC80).

An SLC80 rating is determined based on how well the hearing protector performed in a laboratory. However, each hearing protector's SLC80 is not always a good estimate for workplace noise reduction. Many factors, such as the relationship between the size of the wearer and size of the hearing protector, and how it has been inserted or fitted, can impact how effective that hearing protector will be. That's why it is so important to have the E-A-Rfit validation system as part of your hearing conservation program and the support of a hearing protection team with over 40 years of expertise.

At 3M, we understand the challenges of the workplace, the complexities of fitting protection devices, and the importance of creating adaptable solutions for maximising hearing protection. Our innovations in noise protection and validation are designed to solve real-world challenges, providing our customers with the advanced and comprehensive solutions needed to help protect workers.

# When it comes to protecting workers' hearing there is no one-size fits all solution.



The first step is an accurate assessment of the sound level. The second step is choosing the right protection for the job, and the third is to use a validation system to verify that the protection being used is at the right level for the given environment.

All of this should be consistently supported by a strong educational effort around noise awareness, fitting guidance and other motivational elements.

3M delivers a complete set of tools to **Protect** and **Validate**. It's 3M hearing protection solutions made innovatively easy.



**Detection:** Detecting and monitoring manufacturing noise exposure is the first step in identifying where hearing protection is needed.



**Protection:** Protecting hearing and enhancing communication require comfortable solutions with options that make it easy to select the right protection for each employee.



**Validation:** 3M recommends fit testing for hearing protection. Training on the proper use of protection and measurement of attenuation levels can help you validate that your employees are protected.



# What types of sounds require hearing protection?

At home and work, it's important to understand which sounds may cause hearing loss and require hearing protection:

## Home Scale Decibels (dBA)\*

12-Gauge Shotgun	165 dB Peak
Basketball Game Crowd Noise	120
Chainsaw	110
Rock Concert	105
Motorcycle	100
Lawn Mower	90
Vacuum Cleaner	80
Mid-Sized Auto Interior	70
Conversation	60
Floor Fan	50
Refrigerator Hum	40
Rustling Leaves	30
Watch Ticking	20

## Work Scale Decibels (dBA)\*

Jet Takeoff	140
Pneumatic Riveter	124
Hammer Drill	114
Tractor / Hand Drill	97
Belt Sander	93
City Traffic	78
Air Conditioning Unit	60
Electrical Transformer	45

\* Information from 3M™ Noise Navigator™ Sound Level Database [www.3M.com/hearing](http://www.3M.com/hearing) and National Institute for Occupational Safety and Health (NIOSH) [www.cdc.gov/niosh/topics/noise/noisemeter.html](http://www.cdc.gov/niosh/topics/noise/noisemeter.html)



# It starts with PAR.

## How do you decide what Hearing Protection you will offer to your workers?

If you are simply using the SLC80 rating found on the box of earplugs as a guide, you may not be providing accurate protection levels for every worker. Ears come in many shapes and sizes and to make sure all workers are getting the protection they need, you need to know their Personal Attenuation Rating (PAR).

### What's your PAR?

Every employee is different. Every job is different. Every ear is different. Finding each employee's PAR will help you have assurance that workers' hearing is protected and they are compliant with the law. That's why we made the new 3M™ E-A-Rfit Dual-Ear Validation System fast, accurate and easy.

### Fit testing is key.

Get results you can trust. The 3M™ E-A-Rfit Dual-Ear Validation System measure the effectiveness of the earplug or earmuff inside the employee's ear providing accurate, quantitative results. Because you can simultaneously test both ears, you have more to focus on education including the importance of fit and protection.

✓ **29 dB**

#### Pass.

A "pass" result means the hearing protection is inserted properly and provides sufficient protection for the worker's specific job.

✗ **10 dB**

#### Fail.

A "fail" result means the hearing protection is either not inserted properly or is the wrong type or size for the worker's ear canal.

## Noise-induced hearing loss is 100% preventable.



### Why 3M?

As the leader in hearing protection, 3M offers a complete solution, with dual-ear and earmuff testing capabilities plus a user-friendly interface. The 3M™ E-A-Rfit Dual-Ear Validation System is the fast and easy way to find your employees' PAR, because we know how important it is to make your hearing conservation program fit seamlessly into your operation.

### 3M™ E-A-Rfit Dual-Ear Validation System

#### Features

- Dual-ear testing
- Fast, clear, accurate results
- Earmuff testing capability
- Tests all 7 frequencies
- Seamless software integration
- Science-based, quantitative testing
- Compact design

NOTE: Finding each employee's PAR is an essential step in a comprehensive hearing conservation program. Once a worker's PAR is measured, you can determine if they're using the right hearing protection and they are trained on proper use.



# Earplugs

Our 3M™ Earplug range provides great comfort, fit and good protection. 3M provides a wide range of earplug types to suit your individual needs. From disposable, reusable, push-ins or banded types.

# Disposable Earplugs.

3M™ Disposable Earplugs, made from expandable slow-recovery foam, help provide a great combination of comfort and hearing protection for users. Once in the ear, foam earplugs expand to conform to the unique shape of each ear canal. 3M provides a wide range of disposable roll-down earplugs so you can choose the best solution for your individual needs.

## 3M™ E.A.R™ Classic Earplugs

Classic earplugs were the industry's first foam earplugs, virtually revolutionising hearing protection. Today, the revolution continues. It meets more wearer and environmental needs with its proprietary foams, preferred cylindrical shape, and proven in-ear comfort.

### Features and Benefits:

- Moisture Resistant
- Slow-Recovery Foam
- E-A-Rfit Testable
- Uncorded - 23dB (Class 4)
- Corded - SLC80 21dB (Class 3)
- 2000 pairs/case
- 200 pairs/box



3M Order Code	Model #	Description
70071514940	311-1101	E-A-R Classic Corded
70071514916	310-1001	E-A-R Classic Pillow Pack Uncorded
70071514932	312-1201	E-A-R Classic Polybag Uncorded
70071562774	393-2003-50	E-A-R Classic Probed Test Plug

# Earplugs

## 3M™ E.A.R™ Classic Platinum Earplugs

- 7% Smaller than Classic
- Moisture Resistant
- Slow-Recovery Foam
- E-A-Rfit Testable
- SLC 80 23dB (Class 4)
- 2000 pairs/case
- 200 pairs/box



3M Order Code	Model #	Description
70071515848	310-4002	E-A-R Classic Platinum Pillow Pack Uncorded
70071515871	310-4003	E-A-R Classic Platinum Polybag Uncorded
70071562816	393-2007-50	E-A-R Classic Platinum Probed Test Plug

## 3M™ E.A.Rsoft™ Neons Earplugs

- Slow-Recovery Foam
- Two sizes available
- E-A-Rfit Testable
- SLC 80 23dB (Class 4)
- 2000 pairs/case
- 200 pairs/box



3M Order Code	Model #	Description
70071515020	312-1250	E-A-Rsoft Neons Regular Uncorded
70071515152	311-1251	E-A-Rsoft Neons Large Corded
70071515053	312-1251	E-A-Rsoft Neons Large Uncorded
70071562741	393-2000-50	E-A-Rsoft Neons Probed Test Plug
70071650249	393-2014-50	E-A-Rsoft Neons Large Probed Test Plug

## 3M™ E.A.Rsoft™ SuperFit Earplugs

- Available with Cord
- Slow-Recovery Foam
- E-A-Rfit Testable
- SLC 80 24dB (Class 4)
- 2000 pairs/case
- 200 pairs/box



3M Order Code	Model #	Description
70071515145	311-1254	E-A-Rsoft Superfit Regular Corded
70071515061	312-1255	E-A-Rsoft Superfit Large Uncorded
70071515038	312-1256	E-A-Rsoft Superfit Regular Uncorded

## 3M™ E.A.Rsoft™ FX Earplugs

- Available with Cord
- Slow-Recovery Foam
- Easy removal (bell shape)
- E-A-Rfit Testable
- SLC 80 26dB (Class 5)
- 2000 pairs/case
- 200 pairs/box



3M Order Code	Model #	Description
70071515137	312-1260	E-A-Rsoft FX Corded
70071515046	312-1261	E-A-Rsoft FX Uncorded
70071562782	393-2004-50	E-A-Rsoft FX Probed Test Plug

## 3M™ E.A.R™ Taperfit II Earplugs

- Available with Cord
- Slow-Recovery Foam
- E-A-Rfit Testable
- SLC 80 26dB (Class 5)
- 2000 pairs/case
- 200 pairs/box



3M Order Code	Model #	Description
70071515228	312-1219	E-A-R Taperfit II Regular Uncorded
70071515236	312-1221	E-A-R Taperfit II Large Uncorded
70071515251	312-1224	E-A-R Taperfit II Large Corded
70071562808	393-2006-50	E-A-R Taperfit II Probed Test Plug
70071733557	393-2027-50	E-A-R Taperfit II Large Probed Test Plug

## 3M™ 1100 & 1110 Earplugs

- Available with Cord
- Hypo-allergenic Foam
- E-A-Rfit Testable
- SLC 80 21dB (Class 3)
- Uncorded - 1000 pairs/case
- Uncorded - 200 pairs/box
- Corded - 500 pairs/case
- Corded - 100 pairs/box



3M Order Code	Model #	Description
70070406304	1100	1100 Earplugs Uncorded
70070406312	1110	1110 Earplugs Corded
70071577772	393-2010-50	1100 Probed Test Plug

## Push-to-Fit Earplugs.

Simply hold 3M™ Push-to-Fit Earplugs by the stem then push them into place — there is no roll-down required. The soft foam tip quickly adjusts to the shape of the ear to help create a noise-reducing seal. Since you don't touch the foam tip, they are easy to insert and keep clean, even when your hands are dirty or you are wearing gloves.

### 3M™ Skull Screws™ Earplug

Skull Screws™ earplugs perform as tough as they look by providing excellent hearing protection for noisy environments. The metallic color makes the earplugs look solid, but they are made from ultra-soft foam that provides day-long comfort. Grab the attention of your young workers with these radically designed earplugs and help boost hearing protection acceptance.

- Available with Cord
- Slow-Recovery Foam
- E-A-Rfit Testable
- No Roll-Down Required
- SLC 80 26dB (Class 5)
- 480 pairs/case
- 120 pairs/box



3M Order Code	Model #	Description
70071515640	P1300	Skull Screws Uncorded
70071515632	P1301	Skull Screws Corded
70071647757	393-2012-50	Skull Screws Probed Test Plug

### 3M™ E.A.R™ Push-Ins Earplugs

- Available with Cord
- E-A-Rform™ Foam Tip
- E-A-Rfit Testable
- No Roll-Down Required
- SLC 80 23dB (Class 4)
- 2000 pairs/case
- 200 pairs/box



3M Order Code	Model #	Description
70071515673	318-1002	E-A-R Push-Ins Uncorded
70071515707	318-1003	E-A-R Push-Ins Corded
70071562766	393-2002-50	E-A-R Push-Ins Probed Test Plug

### 3M™ E.A.R™ Push-Ins With Grip Rings Earplugs

- Available with Cord
- Patented Grip Rings
- E-A-Rfit Testable
- No Roll-Down Required
- SLC80 24dB Class 4
- 2000 pairs/case
- 200 pairs/box



3M Order Code	Model #	Description
70071515657	318-1008	E-A-R Push-Ins With Grip Rings Uncorded
70071515681	318-1009	E-A-R Push-Ins With Grip Rings Corded
70071650298	393-2015-50	E-A-R Push-Ins With Grip Rings Probed Test Plug

### 3M™ E.A.R™ Express Pods Earplugs

- Available with Cord
- Slow-Recovery Foam
- E-A-Rfit Testable
- No Roll-Down Required
- SLC 80 19dB (Class 3)
- 400 pairs/case
- 100 pairs/box



3M Order Code	Model #	Description
70071516002	321-2115	E-A-R Express Pods Corded
70071516010	321-3200	E-A-R Express Pods Uncorded
70071562725	393-2008-50	E-A-R Express Pods Probed Test Plug

### 3M™ No-Touch™ Earplugs

- Available with Cord
- Slow-Recovery Foam
- E-A-Rfit Testable
- No Roll-Down Required
- SLC 80 25dB (Class 4)
- 400 pairs/case
- 100 pairs/box



3M Order Code	Model #	Description
70071515624	P2000	No Touch Uncorded
70071515616	P2001	No Touch Corded
70071650231	393-2013-50	No Touch Probed Test Plug

## Reusable Earplugs.

These durable, long-lasting earplugs are made from soft, flexible materials that are washable and reusable. The tapered tips are pre-molded for a wide range of ear sizes. Available in a variety of styles and protection levels.

### 3M™ E-A-R™ UltraFit™ Earplugs

A proven triple-flange design and pliable, premolded material make UltraFit earplugs a more comfortable fit for most ear canals. These durable, reusable earplugs are easy to use again and again, reducing waste. They can be cleaned easily with soap and water. Since there is no need to roll them down before fitting, simply push them into the ear canal for clean and comfortable noise reduction.

- Moisture Resistant
- Reusable, No Roll-Down
- E-A-Rfit Testable
- SLC 80 18dB (Class 3)
- Corded & Uncorded - 400 pairs/case
- Corded & Uncorded - 100 pairs/box
- Corded with case - 200 pairs/case
- Corded with case - 50 pairs/box



3M Order Code	Model #	Description
70071521143	340-4001	E-A-R Ultrafit Cased Uncorded
70071515798	340-4002	E-A-R Ultrafit Cased Corded
70071515772	340-4004	E-A-R Ultrafit Polybag Corded
70071562758	393-2001-50	E-A-R Ultrafit Probed Test Plug

### 3M™ 1200 Reusable Earplugs

- Reusable, No Roll-Down
- 18dB (Class 3)
- E-A-Rfit Testable
- Corded - 500 pairs/case
- Corded - 100 pairs/box
- Corded with case - 250 pairs/case
- Corded with case - 50 pairs/box



3M Order Code	Model #	Description
AT010561119	1270	1270 Earplugs Corded
AT010561127	1271	1271 Earplugs Cased Corded
7100034169	1200	1200 Probed Test Plug

### 3M™ Tri-Flange™ Earplugs

- Moisture Resistant
- Reusable, No Roll-Down
- Vinyl or Cloth cord
- E-A-Rfit Testable
- 19dB (Class 3)
- 400 pairs/case
- 100 pairs/box



3M Order Code	Model #	Description
70071515723	P3000	Tri-Flange Corded
70071515715	P3001	Tri-Flange Cloth Corded
70071647740	393-2011-50	Tri-Flange Probed Test Plug

### 3M™ Combat Arms 4.1 Earplug with dual mode attenuation

- Reusable, No Roll-Down
- Dual Mode Rocker Switch
- E-A-Rfit Testable
- Open Mode Pass Through
- Closed Mode Loud Impulse Noise
- Military, Law Enforcement Markets
- Open Mode - SLC80 9dB (Class 1)
- Closed Mode SLC80 12dB (Class 1)



3M Order Code	Model #	Description
70071675014	370-1044	E-A-R Combat Arms 4.1, Small
70071675022	370-1045	E-A-R Combat Arms 4.1, Medium
70071675030	370-1046	E-A-R Combat Arms 4.1, Large

Does not have probed test plugs

# Metal Detectable Earplugs.

All 3M™ Metal Detectable Earplugs have an integral stainless steel ball encased in the earplug. Ideal for use in food manufacturing industries, when contamination prevention is critical.

## 3M™ E-A-Rsoft™ Neon Metal Detectable Earplugs

3M™ E-A-Rsoft™ Neon Metal Detectable earplugs were specially developed for food processing and other industries where it is critical to keep earplugs from contaminating products and processes. Recognized by most metal-sensing systems, these earplugs feature an implanted stainless steel ball bearing in the plug and metal particles in the cord.

- Slow recovery foam
- Implanted stainless steel ball
- SLC 80 23dB (Class 4)
- Corded - 2000 pairs/case
- 200 pairs/box
- E-A-Rfit Testable

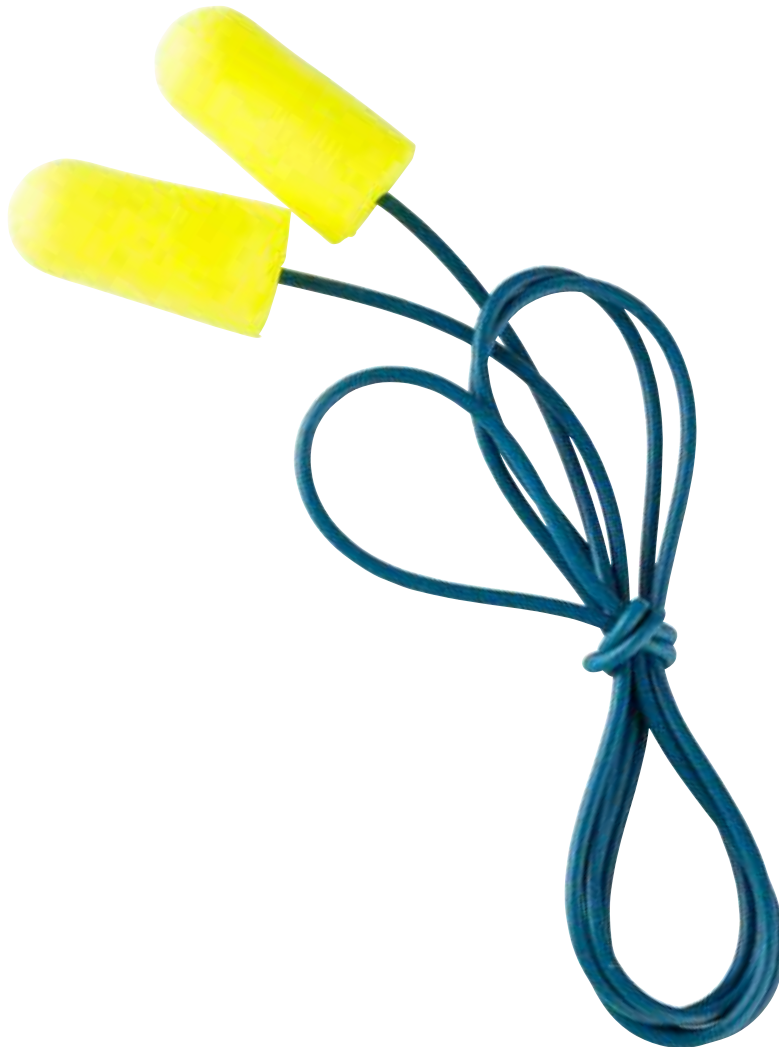

3M Order Code	Model #	Description
70071515103	311-4106	E-A-Rsoft Yellow Neon Metal Detectable Corded
70071562741	393-2000-50	E-A-Rsoft Yellow Neon Metal Detectable Probed Test Plug

## 3M™ E-A-R™ Ultrafit™ Metal Detectable Earplugs

- Triple flange design
- Reusable, no Roll-down
- Implanted stainless steel ball
- 18dB (Class 3)
- 400 pairs/case
- 100 pairs/box
- E-A-Rfit Testable



3M Order Code	Model #	Description
70071515749	340-4007	E-A-R Ultrafit Metal Detectable Corded
70071562758	393-2001-50	E-A-R Ultrafit Metal Detectable Probed Test Plug

# Banded Hearing Protectors.

Banded hearing protectors are an easy-to-use, convenient alternative to earplugs and earmuffs. They are quick to put on and take off and may be stored around the neck in between uses, making them excellent for intermittent use.

## 3M™ E-A-Rflex™ Banded Earplugs

- Replacement Tips Available
- Flexible Band
- Multi Pivot Tips
- E-A-Rflex Tips – SLC80 15dB (Class 2)
- 10 bands/case

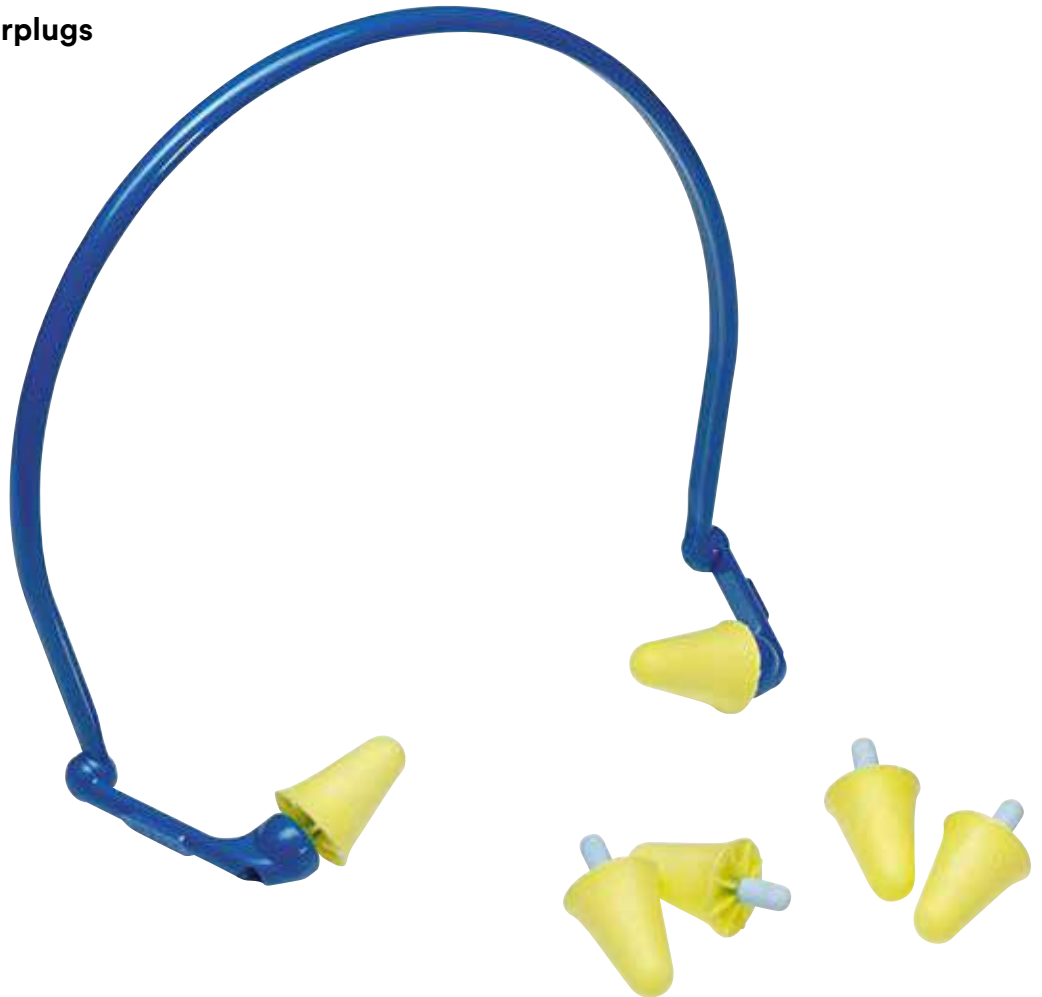

3M Order Code	Model #	Description
70071515806	350-3001	E-A-Rflex Foam

Does not have probed test plugs

## 3M™ 1310 Banded Series

- Replacement Tips Available
- Flexible Band
- Round Foam Tips
- Worn under chin - 18dB (Class 3)
- 50 bands/case



3M Order Code	Model #	Description
AT010561135	1310	3M 1310 Banded Series (Under Chin Position)
H0001861683	1311	3M 1311 Banded Series (Replacement Pods)

Does not have probed test plugs



## 3M™ E.A.R™ One Touch Earplug Dispensers

3M™ One Touch™ Pro Earplug Dispenser gives workers convenient access to hearing protection products. A "No-Waste Funnel" accurately delivers earplugs with a slight turn. It typically dispenses a single earplug with each turn, giving the worker more control with less chance of spillage and waste of earplugs.

### Features and Benefits:

- Makes it easy for workers to get the earplugs they need on the job. The dispenser holds 400-500 pairs of earplugs that are dispensed one at a time with a simple turning motion. Because the dispensing of earplugs is controlled, there should be little waste
- Our dispenser also makes it more sanitary for workers to get their earplugs as it eliminates the practice of workers reaching into a bin and touching multiple earplugs.
- The 3M One Touch Pro Earplug dispenser may be placed on flat, level surfaces such as countertops, or wall mounted in a convenient place. For wall mounting applications, a powder-coated steel backplate is included
- Accurately dispenses one earplug at a time
- Dispenses earplug directly into hand
- Durable ABS plastic for tough environments
- Can be free-standing or wall-mounted
- Shields earplugs from wind and rain



Classic™



Yellow Neons™



SuperFit™



1100

3M Order Code	Model #	Description
XA007701783	1100-BT	3M™ 1100 One Touch™ Refill - 500 pair/bottle 4 bottles/case, SLC80 21dB (Class 3)
70071514882	391-1001	3M™ Classic™ One Touch™ Refill - 500 pair/bottle 4 bottles/case, SLC80 23dB (Class 4)
70071515087	391-1004	3M™ E-A-Rsoft™ Yellow Neons™ One Touch™ Refill - 500 pair/bottle 4 bottles/case, SLC80 23dB (Class 4)
70071674751	390-1012	3M™ E-A-Rsoft FX™ One Touch™ Refill Bottle 500 pair/bottle 4 bottles/case, SLC80 26dB (Class 5)
70071674207	391-0000	3M™ One Touch™ Pro - Earplug Dispenser



# Earmuffs

The 3M™ PELTOR™ Earmuffs have been developed for demanding noisy environments and are effective in reducing even extremely low frequency sound. The sealing rings are filled with a unique combination of liquid and foam. The result is an optimum seal with low contact pressure, which provides agreeable comfort even during long periods of use.

## 3M™ Peltor™ X4 Series Earmuffs

Extremely lightweight, low-profile earmuffs for use in high-noise exposure situations

Historically higher attenuating earmuffs meant larger and bulky cups, but no longer. The 3M™ PELTOR™ Earmuffs X4 can attenuate by as much as 31dB whilst maintaining a sleek, low profile aesthetically pleasing design. Using the same innovative technology, the 3M™ PELTOR™ X5 remains relatively lightweight with excellent balance and wearer comfort despite the larger cups, providing ratings as high as SLC80 35dB.

### Features and Benefits:

#### Comfort

- Easy to adjust headband
- Comes in electrically insulated (dielectric) and wire formats
- Twin headband design helps reduce heat build-up and provides a good fit and balance
- Earcups tilt for optimum comfort and efficiency

#### Protection

- Unique attenuation as a result of optimum combination of specially-formulated foam featured in the earcups, cushions and the innovative spacer and cup design
- Newly designed spacer improves attenuation without excess bulk or weight
- Also available in helmet attached and neckband versions.

#### Design

- Extremely lightweight (234g)
- Integrated design for more robustness
- Colour-coded for ease of selection
- Easy to clean
- Extremely slim design providing excellent compatibility with other 3M personal protection products



3M Order Code	Model #	Description
XA007707947	X4A	Headband Earmuffs X Series Light Green SLC80 31dB (Class 5)
UU008197848	X4B	Neckband Earmuffs X Series Light Green SLC80 31dB (Class 5)
UU010818886	X4P3GS/E	Helmet Attach Earmuffs X Series Light Green SLC80 27dB (Class 5)
AT010613571	X4P5E/G	Helmet Attach Dielectric Earmuffs X Series Light Green SLC80 26dB (Class 5)
XA007707608	HYX4	Replacement Hygiene Kit for X4 Earmuff Models

# Earmuffs

## 3M™ Peltor™ X5 Series Earmuffs

3M's highest attenuation earmuffs for very high-noise exposures



3M Order Code	Model #	Description
XA007707954	X5A	Headband Earmuffs X Series Black SLC80 35dB (Class 5)
UU008197863	X5B	Neckband Earmuffs X Series Black SLC80 34dB (Class 5)
XA007707988	X5P3G/E	Helmet Attach Earmuffs X Series Black SLC80 31dB (Class 5)
AT010613589	X5P5G/E	Helmet Attach Dielectric Earmuffs X Series Black SLC80 31dB (Class 5)
XA007707616	HYX5	Replacement Hygiene Kit for X5 Earmuff Models

## 3M™ Peltor™ Optime™ II Earmuffs

These products are designed to provide moderate to high level of attenuation that meets the needs of many industrial applications where high levels of noise may be encountered.



3M Order Code	Model #	Description
70071730520	H520P3GS/E	Helmet Attach Earmuffs Optime™ II Series Green SLC80 29dB (Class 5)
70071730538	H520F	Foldable Helmet Attach Earmuffs Optime™ II Series Green SLC80 32dB (Class 5)
70071730546	H520B	Neckband Earmuffs Optime™ II Series Green SLC80 27dB (Class 5)
70071730553	H520A	Headband Earmuffs Optime™ II Series Green SLC80 32dB (Class 5)
70071730579	H520FHV	Foldable Headband Earmuffs Optime™ II Series Hi Viz SLC80 32dB (Class 5)
XA007707582	HYX2	HYX2 Replacement Hygiene Kit for Optime II Series
70071691110	393-3001-2	PELTOR X1/X2 Earmuff Probed Test Cushions

## 3M™ Peltor™ H31 Low Profile Series

Bright orange coloured earcups for added visibility



3M Order Code	Model #	Description
AT010592841	H31P3AF	Earmuffs for M-Series Head Tops, M100 = Class 3, M-300 = Class 4

## 3M™ Peltor™ Optime™ I Earmuffs

These products are designed to provide moderate level of attenuation that meets the needs of the majority of industrial applications.



3M Order Code	Model #	Description
70071730496	H510P3GS/E	Helmet Attach Earmuffs Optime™ I Series Yellow SLC80 26dB (Class 5)
70071730504	H510F	Foldable Helmet Attach Earmuffs Optime™ I Series Yellow SLC80 28dB (Class 5)
70071730421	H510B	Neckband Earmuffs Optime™ I Series Yellow SLC80 25dB (Class 4)
70071730454	H510A	Headband Earmuffs Optime™ I Series Yellow SLC80 28dB (Class 5)
XA007707574	HYX1	HYX1 Replacement Hygiene Kit for Optime I Series
70071691110	393-3001-2	PELTOR X1/X2 Earmuff Probed Test Cushions

## 3M™ Peltor™ Optime™ III Earmuffs

These products are designed to provide a high level of attenuation that meets the needs of many industrial applications where high levels of noise may be encountered.



3M Order Code	Model #	Description
70071730587	H540P3GS/E	Helmet Attach Earmuffs Optime™ III Series Black/Red SLC80 30dB (Class 5)
70071730595	H540B	Neckband Earmuffs Optime™ III Series Black/Red SLC80 34dB (Class 5)
70071730603	H540A	Headband Earmuffs Optime™ III Series Black/Red SLC80 33dB (Class 5)
70071730629	H540AHV	Headband Earmuffs Optime™ III Series Hi Viz SLC80 33dB (Class 5)
XH001659362	HY54	HY54 Replacement Hygiene Kit for Optime III Series
70071676285	393-3004-2	PELTOR Earmuffs Probed Test Cushions

## 3M™ Peltor™ H505B Welders Earmuffs

Low-profile design that fits comfortably under most welding helmets.



3M Order Code	Model #	Description
XA007703797	H505B	Black Neckband Format Earmuffs, Class 4 SLC80 22dB
XA007704274	H505	Hygiene Kit for H505



# Communications

Close up or far away the 3M™ PELTOR™ Communication Solutions for noisy environments make it possible for users of hearing protectors to communicate very effectively – with their immediate environment and with people further away.

# The safe way to be heard, and get things done.

### Work never sounded this good.

There was a time when wearing hearing protectors meant being isolated and out of contact. Those days are over. Today, the 3M™ Peltor™ Brand of Products offers communication solutions that not only make your working day safer and more efficient, but also much smarter.

To be effective, a hearing protector should be used 100% of the time in noisy environments. Even taking it off for a short time dramatically reduces its effectiveness and greatly increases the risk of hearing damage. 3M™ Communication Solutions Products make it possible for your team to communicate more easily in high-noise areas.

Communication devices are key to both safety and productivity. Integrating a 3M Communication Solution in your work environment will help you communicate more clearly with co-workers while reducing your exposure to potential hazardous noise. Feel free to contact us to discuss a solution to meet your specific needs.

### Just what you want to hear.

Active control of incoming sounds from your surroundings lets you hear alarm signals and machines, while harmful levels of noise are filtered out by smart electronics.

### Music to your ears.

Communication with people around you involves using our level-dependent function for ambient listening systems. For longer distances, you have built-in two-way radios and Bluetooth® Connections to mobile phones. Meanwhile all communication options can also be combined with a sound system so you can listen to your favourite streamed music or pod radio, with first-class sound quality.





## Function symbols.

To help you understand the functionality of the products, below is an explanation of the symbols you will find on the products.



Hearing protection with built-in AM/FM radio



Hearing protection for communicating with external two-way radio



Hearing protection with built-in two-way radio



Hearing protection with level-dependent function for environmental listening limited to max 82 dB



Hearing protection with external audio input

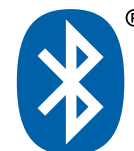

Bluetooth® Connectivity

# 3M™ Peltor™ WS™ Alert™ XPI Headset

## Multipoint bluetooth headset with noise cancelling microphone and situational awareness

The 3M™ PELTOR™ WS™ ALERT™ XPI Headset is the next generation protective communication solution. With Bluetooth® wireless communication, noise-cancelling boom microphone, integrated FM Radio and level-dependent function for ambient listening, the WS™ ALERT™ XPI Headset not only helps protect you against hazardous noise, but also makes it easy to make phone calls with both hands free in noisy environments.

### Features and Benefits:

- High attenuating hearing protector in two models: stand-alone headband or safety helmet attachment
- Bluetooth® MultiPoint Technology for connection to one or two external devices for hands-free talk and streaming Noise cancelling boom microphone for clear speech transmission in noisy environments
- Level-dependent function for ambient listening to help improve your situational awareness (limited to 82dB)
- Push-to-Listen feature to easily and instantaneously listen to your surroundings
- Built-in FM-Radio with radio volume limited to 82dB
- Voice guided menu system with announced FM-Radio frequencies
- Digital station search
- Ability to store up to 4 favourite stations
- Auto power off: The headset will turn off after 4 hrs of non-use to save battery
- Connectivity to Mobile App
  - Helps you to set up and navigate your headset via the 3M Connected Equipment Mobile App
- E-A-Rfit Testable



3M Order Code	Model #	Description
UU010322954	MRX21A3WS6-AZ	3M Peltor WS Alert XPI APP, Headband Headset SLC80 30dB (Class 5)
UU010322962	MRX21AP3EWS6-AZ	3M Peltor WS Alert XPI, Helmet Attach Headset, APP, SLC80 29 dB (Class 5)
UU008567388	HY82	Replacement Hygiene Kit for WS Alert XPI



# Communications

## 3M™ PELTOR™ ProTac™ III Headset

The 3M™ PELTOR™ ProTac™ III hearing protector helps safeguard against harmful noise, whilst allowing ambient sounds to be heard at a level below 82dB. This attribute increases your situation awareness and ability to communicate with nearby colleagues, as well as hearing warning signals, approaching vehicles or sounds produced by machines and industrial processes.

- Built-in level-dependent function for situational awareness
- 3.5mm listen only input (two-way radio, mobile)
- Voice Guided Menu System
- Loud Impact Noise Suppression
- Auto Shut Off
- Standard Cup version and Slim cup version
- E-A-Rfit Testable



3M Order Code	Model #	Description
UU004637771	MT13H220P3E	Slim Headset, black, helmet attachment, SLC80 24dB (Class 4)
UU004690614	MT13H221P3E	Headset, black, helmet attachment, SLC80 30dB (Class 5)
UU004637789	MT13H220A	Slim Headset, black, headband, SLC80 26dB (Class 5)
UU004690622	MT13H221A	Headset, black, headband, SLC80 32dB (Class 5)
UU008049353	HY220	Replacement Hygiene Kit for ProTac III Headsets

## 3M™ PELTOR™ SportTac™ Hunting Folding Headband

- Electronic level dependent hearing protector designed for hunting and shooting.
- Approximately 600 hours operation time and uses the HY21 Hygiene Kit.



3M Order Code	Model #	Description
XH001650049	MT16H210F-478-GN	3M™ Peltor™ Folding Headband, Level Dependent, Green/Orange SLC80 24db (Class 4)
XH001650056	MT16H210F-478-RD	3M™ Peltor™ Folding Headband, Level Dependent, Red/Black SLC80 24db (Class 4)
XH001659305	HY21	Replacement Hygiene Kit for SportTac Headset

## 3M™ Peltor™ Worktunes Pro AM/FM Radio Headset

- Dual shell designed to protect the electronic circuitry inside the cup
- 3.5mm jack: A listen-only stereo input to connect to a mobile phone, two-way radio or other external devices (limited to 82dB)
- 2 x AA batteries: Lasting for approx. 100 hours of use
- E-A-Rfit Testable



3M Order Code	Model #	Description
UU004690713	HRXS221A	3M™ Peltor™ Worktunes Pro AM/FM Radio Headset, black, headband SLC80 32dB (Class 5)
UU004690663	HRXS221P3E	3M™ Peltor™ Worktunes Pro AM/FM Radio Headset, black, helmet attachment SLC80 30dB (Class 5)
UU008049353	HY220	Replacement Hygiene Kit for Worktunes Pro Headset

## 3M™ Peltor™ ProTac Hunter/Shooter Headset

- Dual shell designed to protect the electronic circuitry inside the cup
- 3.5mm jack: A listen-only stereo input to connect to a mobile phone, two-way radio or other external devices (limited to 82dB)
- 2 x AA batteries: Lasting for approx. 100 hours of use



3M Order Code	Model #	Description
UU004690648	MT13H222A	3M™ Peltor™ ProTac Hunter Headset, green, headband SLC80 26dB (Class 5)
UU004690630	MT13H223A	3M™ Peltor™ ProTac Shooter Headset, green, headband SLC80 32dB (Class 5)
U008049353	HY220	Replacement Hygiene Kit for Hunter & Shooter Headsets

# Communications

## 3M™ PELTOR™ WS™ LiteCom Plus with Bluetooth®

3M™ PELTOR™ WS™ LiteCom Plus with Bluetooth® opens up a world of communication with your built-in two-way radio headset at the hub. You become a mobile, hands-free communication center, the built-in two-way radio and wireless connections to your computer and cell phone. You can take your calls, or stream music thanks to electronics that let you switch easily between functions.

The level-dependent technology lets you hear ambient sounds such as external alarm signals or approaching vehicles. It also allows face to face communication at close distance. Robust design (IP54 certified), clear controls and an intuitive menu system

- Built in two-way radio communication
- Range of up to 3km depending on conditions
- 69 channels (LPD 433 MHz)
- 121 subchannels
- Connect different devices (radio, mobile phone) via Bluetooth® Multi-Point
- IP54 certified
- Level dependent function for ambient listening
- Rechargeable lithium-ion battery with 20 hours operating time
- Noise cancelling waterproof microphone (IP68)
- Voice operated transmission (VOX)
- Auto power off function
- Battery status indication
- Voice guided menu system
- Connects with Bluetooth compatible devices
- Two-way radio (via flex cable or Bluetooth®)



3M Order Code	Model #	Description
UU010265963	MT73H7A4310WS6AZ	WS LiteCom Plus, 2-way LPD 433, headband SLC80 32dB (Class 5)
UU010265971	MT73H7B4310WS6AZ	WS LiteCom Plus, 2-way LPD 433, neckband SLC80 30dB (Class 5)
UU010264578	MT73H7P3E4310WS6AZ	WS LiteCom Plus, 2-way LPD 433, helmet attached SLC80 29dB (Class 5)
UU008197921	HY83	Replacement Hygiene Kit for WS LiteCom Plus Headsets

## 3M™ Peltor™ WS ProTac XPI Headset

The 3M Peltor™ WS Series ProTac XPI Headsets is an active-hearing protector that features Bluetooth® 4.2 Technology. This enables work with both hands free while taking calls via two-way radio or mobile phones. The ambient listening function lets users hear surrounding noise and converse with colleagues.

- Bluetooth 4.2 including MultiPoint.
- New FLX2 flex jack (for -111 headsets)
- New noise cancelling water resistant speech microphone. Improved speech intelligibility and IP68 rated for use in noisy and demanding environments.
- Support for Bluetooth A2DP, streaming (selectable in Set-up mode).
- E-A-Rfit Testable



3M Order Code	Model #	Description
UU010123527	MT15H7AWS6	3M™ Peltor™ WS™ ProTac XPI Headset, headband SCL80 32dB (Class 5)
UU010123535	MT15H7P3EWS6	3M™ Peltor™ WS™ ProTac XPI Headset, helmet attachment SCL80 27dB (Class 5)
UU010123543	MT15H7AWS6-111	3M™ Peltor™ WS™ ProTac XPI FLX2 Headset, headband SCL80 32dB (Class 5)
UU010123568	MT15H7BWS6-111	3M™ Peltor™ WS™ ProTac XPI FLX2 Headset, neckband SCL80 29dB (Class 5)
UU010123550	MT15H7P3EWS6-111	3M™ Peltor™ WS™ ProTac XPI FLX2 Headset, helmet attachment SCL80 27dB (Class 5)
UU008197921	HY83	Replacement Hygiene Kit for WS ProTac XPI Headsets

# Communications

## 3M™ PELTOR™ CH-3 Listen Only Headset

The 3M™ PELTOR™ CH-3 FLX2 Listen only Hearing Protector can enhance communication in noisy environments. Suitable for workers connected to 'listen only' their 2-way handheld radio, mobile or fixed systems.

- Bright yellow colour for enhanced visibility
- Detachable down lead FLX2 connector for high flexibility
- Improved speaker efficiency to fit todays digital device
- Newly designed headband
- E-A-Rfit Testable



3M Order Code	Model #	Description
UU010252029	HT52A-112	CH-3 Listen Only Headset, Headband SCL80 31dB (Class 5)
UU010252037	HT52B-112	CH-3 Listen Only Headset, Neckband SCL80 30dB (Class 5)
UU010252045	HT52P3E-112	CH-3 Listen Only Headset, Helmet Attach. SCL80 29dB (Class 5)
UU010391918	HY84	Replacement Hygiene Kit for CH-3 Headsets

## 3M™ PELTOR™ CH-3 Flex Headset with PTT

CH-3 Headset is the solution for easy Push-To-Talk (PTT) where it's more convenient to have an external PTT on your chest to control your 2-way radio. Connects via a standard J11 cable to a PTT.

- Waterproof microphone (IP68)
- Easy access PTT (Push-to-Talk) button on side of the cup
- Detachable down lead FLX2 connector for major 2 way radios
- Improved speaker efficiency to fit todays digital device
- Newly designed headband
- E-A-Rfit Testable



3M Order Code	Model #	Description
UU010250932	MT74H52A-111	CH-3 FLX2 Headset with Built-In PTT, Headband SCL80 31dB (Class 5)
UU010249074	MT74H52B-111	CH-3 FLX2 Headset with Built-In PTT, Neckband SCL80 30dB (Class 5)
UU010247599	MT74H52P3E-111	CH-3 FLX2 Headset with Built-In PTT, Helmet Att. SCL80 29dB (Class 5)
UU010391918	HY84	Replacement Hygiene Kit for CH-3 Headsets

## 3M™ PELTOR™ CH-3 Standard J11 Headset

CH-3 Headset is the solution for easy Push-To-Talk (PTT) where it's more convenient to have an external PTT on your chest to control your 2-way radio. Connects via a standard J11 cable to a PTT.

- Waterproof microphone (IP68)
- Bright yellow colour for enhanced visibility
- Detachable down lead FLX2 connector for high flexibility
- Improved speaker efficiency to fit todays digital device
- Newly designed headband
- E-A-Rfit Testable



3M Order Code	Model #	Description
UU010246302	MT74H52A-110	CH-3 FLX2 J11 Headset, Headband SCL80 31dB (Class 5)
UU010246914	MT74H52B-110	CH-3 FLX2 J11 Headset, Neckband SCL80 30dB (Class 5)
UU010246922	MT74H52P3E-110	CH-3 FLX2 J11 Headset, Headband SCL80 29dB (Class 5)
UU010391918	HY84	Replacement Hygiene Kit for CH-3 Headsets

## 3M™ PELTOR™ FLX2 accessory connectors

Detachable down lead connector system to suit a wide range of different cable options to match todays most common 2-way radios and wired solutions.



3M Order Code	Model #	Description	Headset
UU009731140	FLX2-200	J11 Standard Cable	-110
UU010325718	FLX2-201	for Ground Mech	-110
UU010126348	FLX2-111	for Hytera DP7*	-111
UU010124293	FLX2-35	for Icom angeld 2-pin	-111
UU010124301	FLX2-44	for Icom F31/F41	-111
UU010126330	FLX2-64	for Icom F34/F44	-111
UU010054110	FLX2-36	for Kenwood 2-pin	-111
UU009731132	FLX2-107-50	for Kenwood Multipin	-111
UU009898113	FLX2-21	for Motorola GP300/DP1400	-111
UU009879477	FLX2-32	for Motorola GP340	-111
UU010126322	FLX2-65	for Motorola GP344	-111
UU010126314	FLX2-18	for Motorola GP900	-111
UU009731124	FLX2-63-50	for Motorola Mototrbo	-111
UU010123584	FLX2-101	for Sepura STP 8*/9*	-111
UU009898071	FLX2-28	for Mobile/Dect phones	-111
UU009898089	FLX2-202	3,5mm Stereo	-112
UU009731157	FLX2-203	2,5mm Mono	-112
UU009898097	FLX2-204	1/4" Stereo	-112
UU009731165	FLX2-205	3,5mm Mono	-112
UU010346730	FLX2-208	3,5mm Threaded	-112

# Communications

## 3M™ Peltor™ CH-5 Ultra High Attenuation Headset

These 3M PELTOR headsets are intended to help provide protection against hazardous noise levels and very loud sounds. With new innovative technology and design, the CH-5 headset achieve a very high attenuation. A new water tight boom microphone (IP68) is also developed for this product which allows for operation in wet conditions. Easy to use and maintain.

Designed to be used in extreme military environments such as tanks (crew headsets), ground crew around fighter jets and helicopters together with 3M PELTOR PTT Adapters or direct to an intercom system.

- High attenuation on impact noise
- Highest noise attenuation in the market \*
- Water tight microphone (IP68)
- Robust construction, easy to maintain
- E-A-Rfit Testable



3M Order Code	Model #	Description
UU008027532	MT73H450A-38	Headset, Headband, Grey, J11 Peltor SLC80 37dB (Class 5)
UU008027565	MT73H450A-86	Headset, Headband, Grey, J11 NATO SLC80 37dB (Class 5)
UU008027557	MT73H450A-77 GB	Flex Headset, Headband, Hi-Vis, J11 Peltor SLC80 37dB (Class 5)
UU008027573	MT73H450P3E-77 GB	Flex Headset, Helmet, Hi-Vis, J11 Peltor SLC80 35dB (Class 5)
UU008117143	MT73H450A GB	Headset, Headband, Hi-Vis, J11 Peltor SLC80 37dB (Class 5)
UU008117184	MT73H450P3E GB	Headset, Helmet, Hi-Vis, J11 Peltor SLC80 35dB (Class 5)
UU008117135	HY45	Replacement Hygiene Kit for CH-5 Headsets

## 3M™ PELTOR™ Twin Cup ATEX

The Peltor™ Twin Cup Headset, ATEX has high-attenuating shells with optimised acoustic design and excellent space for the ears. Noise compensated microphones for clear and reliable communication. The P3E-version is for helmet attachment and fits all 3M™ Peltor™ helmets and most other helmet brands on the market. ATEX approved.

- ATEX approved for use in areas where intrinsic safety is required
- Dynamic noise cancelling microphone
- Twin-Cup technique for increased attenuation



3M Order Code	Model #	Description
XH001674254	MT72H540P3E-50	3M™ Peltor™ Twin Cup headset, helmet attach SLC80 30dB (Class 5)
XH001659297	HY13	Replacement Hygiene Kit for Twin Cup Headset

# Communications

## 3M™ PELTOR™ EEP-100 Electronic Earplug

The 3M™ PELTOR™ Electronic Earplug helps protect your hearing, and can help improve situational awareness and communications in challenging environments. The earpieces are rechargeable via a USB jack on the charging case providing storage of the earpieces when not being used.

The small and lightweight design makes it compatible with most head borne 3M Personal Safety Equipment (PPE), such as helmets and face shields.

- Hearing protection with interchangeable tips
- Level-dependent function (for situational awareness)
- Intuitive one-button operation
- Rechargeable
- Durable storage and charging case (IP54)
- E-A-Rfit Testable
- Ultra Fit Eartips = SLC80 16 dB (Class 2)
- CCC-GRM-25 Eartips = SLC80 23 dB (Class 4)
- Skull Screw Eartips = SLC80 23 dB (Class 4)



3M Order Code	Model #	Description
70071730785	EEP-100 EU	3M™ PELTOR™ Electronic Earplug, EEP-100 EU
70071673795	TEP-CORD	3M™ PELTOR™ Replacement Cord
70071673746	370-TEPL-25	3M™ UltraFit™ Communication Tips Replacement, Large 25 PR/Case
70071673738	370-TEPM-25	3M™ UltraFit™ Communication Tips Replacement, Medium 25 PR/Case
70071673720	370-TEPS-25	3M™ UltraFit™ Communication Tips Replacement, Small 25 PR/Case
70071675212	CCC-GRM-25	3M™ Triple-C Communication Ear tips 25 PR/Case
70071615275	370-1019-10	3M™ Skull Screw™ Communication Ear Tips

## 3M™ PELTOR™ TEP-200 Tactical Earplug

The 3M™ PELTOR™ Tactical Earplug helps protect your hearing, and can help improve situational awareness and communications in challenging environments. Integrated with level-dependent technology, the TEP-200 helps provide hearing protection in noise and situational awareness in quiet environments. Ear pieces also include a small antenna to allow audio signals to be received wirelessly from a neckloop accessory (sold separately).

- Allow audio signals to be received wirelessly from a neckloop accessory
- Hearing protection with interchangeable tips
- Level-dependent function (for situational awareness)
- Intuitive one-button operation
- Rechargeable through storage and portable charging case (IP67)
- E-A-Rfit Testable
- Ultra Fit Eartips = SLC80 16 dB (Class 2)
- CCC-GRM-25 Eartips = SLC80 23 dB (Class 4)
- Skull Screw Eartips = SLC80 23 dB (Class 4)



3M Order Code	Model #	Description
70071677010	TEP-200	TEP-200 Tactical Earplug Kit
70071677036	TEP-LOOP-200	Wireless Neckloop Accessory
70071673795	TEP-CORD	3M™ PELTOR™ Replacement Cord
70071673746	370-TEPL-25	3M™ UltraFit™ Communication Tips Replacement, Large 25 PR/Case
70071673738	370-TEPM-25	3M™ UltraFit™ Communication Tips Replacement, Medium 25 PR/Case
70071673720	370-TEPS-25	3M™ UltraFit™ Communication Tips Replacement, Small 25 PR/Case
70071675212	CCC-GRM-25	3M™ Triple-C Communication Ear tips 25 PR/Case
70071615275	370-1019-10	3M™ Skull Screw™ Communication Ear Tips





# 3M™ E-A-Rfit™ Validation

3M™ E-A-Rfit™ Dual-Ear Validation System utilizes F-MIRE technology to measure and obtain an objective, quantitative level of employee hearing protection in just 5 seconds per ear. Workers receive their own personal attenuation rating (PAR) and learn how correctly inserting earplugs can increase their level of protection.

# 3M™ E-A-Rfit™ Dual-Ear Validation System.

Get results you can trust. The E-A-Rfit™ Dual-Ear Validation System measures the effectiveness of the hearing protection from inside the employee's ear, providing accurate, quantitative results. And because you can simultaneously test both ears, you'll have more time to educate employees on the importance of fit and compliance.



## ① Fit.

Have the employee insert their earplugs or put on their earmuffs.

## ② Test.

Connect to microphones and begin speaker test sound.

## ③ Assess.

Use PAR to customize hearing protector selection.

## The challenge of hearing protection.

### How do you know if your workforce is protected?

Protecting workers from hazardous noise levels is an ongoing challenge for many organizations. One of the most commonly recorded occupational illnesses in the manufacturing sector is permanent hearing loss. The success of your safety program depends on many factors and requires more than just offering hearing protection.

### Individual Fit Testing Using F-MIRE.

Using F-MIRE (Field Microphone-In-Real-Ear) technology, the E-A-Rfit™ Dual-Ear Validation System generates a

Personal Attenuation Rating (PAR) less than 5 seconds for both ears, taking into account the seven standard measured testing frequencies.

- Measures how well 3M's most popular earplugs, earmuffs and communications headsets perform
- Delivers a quantitative measurement of personal noise reduction for each employee
- Can help identify whether or not the employee has adequate protection



# EarFit Validation

These earplug styles cover fit validation testing for more than 90 different 3M earplug and earmuff products.



3M Order Code	Model #	Description
70071562741	393-2000-50	3M™ E-A-Rsoft™ Yellow Neons™ Probed Test Plugs 50 PR/Case (5 bags of 10 pair each)
70071562758	393-2001-50	3M™ E-A-R™ UltraFit™ Probed Test Plugs 50 EA/Case (5 bags of 10 pair each)
70071562766	393-2002-50	3M™ E-A-R™ Push-Ins™ Probed Test Plugs 50 PR/Case (5 bags of 10 pair each)
70071562774	393-2003-50	3M™ E-A-R™ Classic™ Probed Test Plugs 50 PR/Case (5 bags of 10 pair each)
70071562782	393-2004-50	3M™ E-A-Rsoft™ FX™ Probed Test Plug 50 PR/Case (5 bags of 10 pair each)
70071562808	393-2006-50	3M™ E-A-R™ TaperFit™ 2 Probed Test Plug 50 PR/Case (5 bags of 10 pair each)
70071562816	393-2007-50	3M™ Classic™ Small Probed Test Plug 50 PR/Case (5 bags of 10 pair each)
70071562725	393-2008-50	3M™ E-A-R™ Express™ Pod Plugs™ Probed Test Plug 50 PR/Case (5 bags of 10 pair each)
70071577772	393-2010-50	3M™ 1100 Test Plug 50 PR/Case (5 bags of 10 pair each)
70071647757	393-2012-50	3M™ Skull Screws™ Probed Test Plug 50 PR/Case (5 bags of 10 pair each)
70071650249	393-2014-50	3M™ E-A-Rsoft™ Yellow Neons™ Large Probed Test Plug 50 PR/Case (5 bags of 10 pair each)
70071650298	393-2015-50	3M™ E-A-R™ Push-Ins™ with Grip Rings Probed Test Plug 50 PR/Case (5 bags of 10 pair each)
70071732690	393-2026-50	3M™ E-A-R™ Flexible Fit HA in Polybag
70071733557	393-2027-50	3M™ E-A-R™ TaperFit™ Large

## In Ear Earplug Probe Range

3M Order Code	Model #	Description
70071734431	393-2030-50	3M™ Skull Screws/Torgue™ (regular and metal detectable)
70071734449	393-2031-50	CCC-GRM-25
70071734456	393-2032-50	3M™ UltraFit™ Small
70071734464	393-2033-50	3M™ UltraFit™ Medium
70071734472	393-2034-50	3M™ UltraFit™ Large

## Probed Muffs

3M Order Code	Model #	Description
70071676285	393-3004-2	3M™ PELTOR™ Earmuff Probed Test Cushion A Optime III 2EA/Case (2 pair each per case)
70071691110	393-3001-2	3M™ PELTOR™ Earmuff Probed Test Cushion B Optime I/II, Peltor Comms 2EA/Case (2 pair each per case)
70071691136	393-3005-2	3M™ PELTOR™ Earmuff Probed Test Cushion D X4/X5 2EA/Case (2 pair each per case)

## 3M™ E-A-Rfit™ Dual-Ear Validation System

3M Order Code	Model #	Description
70071674116	393-1100	3M™ E-A-Rfit™ Dual-Ear Validation System
70071674694	073-781	3M™ E-A-Rfit™ Dual-Ear, Microphone Assembly





# Head Protection

Making sure you are covered under any circumstances.

The 3M™ head protection portfolio offers an unrivalled range of products for companies looking for comfortable and high-quality solutions to meet a variety of industrial applications.

# About the range.

The 3M head protection portfolio offers an unrivalled range of products for companies looking for comfortable and high-quality solutions to meet a variety of industrial applications.



### Certified combination.

Where accessories are being used, they should be fully compatible to the safety helmet worn. There are a wide range of accessories which can be fitted to a safety helmet to make it more suitable for variable working conditions.

Examples of accessories are chinstraps, face shields, earmuffs and miners lamp brackets. Care should be taken to ensure that any accessories attached to the safety helmet are compatible.

The range of 3M safety helmets are compatible with the same brand hearing, eye and face protection.

\*Excludes - XH001675053 G2000NUV-VI Safety Helmet Uvicator with Ratchet Harness White and XH001655758 G2000 CUOR31V4-C-01 Lumberjack Combo

# Head Protection

## Which type of safety helmet?

The scope of AS/NZS 1801:1997 standard specifies requirements for occupational protective helmets to protect wearers heads from falling objects in building and construction, quarrying, shipbuilding, forestry, and other occupations with similar hazards. These requirements include the construction and materials of the helmet shell and head harness, mechanical strength of the shell and finish of the helmet. All 3M™ safety helmet shells are made from premium impact resistant ABS plastic or polycarbonate.

In compliance with the standards, objectives to specify protective helmets that are to be worn in a variety of occupations, 3M™ safety helmets are classified into three types:

- Type 1 General industrial safety helmets
- Type 2 Helmets intended for high temperature applications
- Type 3 Helmets intended for bushfire fighting

The Australian and New Zealand Standard AS/NZS 1801 classifies Occupational Safety Helmets into three types that must meet the following requirements:

Classification	Shock Absorption	Penetration by Striker	Side Stiffness	Electrical Resistance	Resistance to Ignition	Very Hot Temp. 120°C	Extremely High Temp. 200°C	Thermal Performance of Shell	Retaining Chin Strap Strength
TYPE 1 General industrial	✓	✓	✓	✓	✓	-	-	-	-
TYPE 2 Hot work places	✓	✓	✓	✓	✓	✓	✓	✓	-
TYPE 3 Bushfire fighting	✓	✓	✓	✓	✓	✓	✓	✓	✓

## What is the working life of a safety helmet?

This is one of the most commonly asked questions asked. All information pertaining to selection, care and use is available in AS/NZS 1800:1998.

Markings on safety helmets are a requirement for certification. It assists users in identifying their intended use. The shell is moulded with very important information stamped on the peak and you should familiarise yourself with the significance of this labelling.

Replace your hard hat at regular intervals - Field tests have shown that generally, helmet shells have a life of at least 3 years from the time of issue. Components of harnesses may deteriorate more rapidly in service and harnesses should, therefore, be replaced at intervals not longer than 2 years.

If the sticker has been removed or unused, replace the helmet three years from the manufacture date stamp, which can be found under the brim or peak of the helmet. In the centre of the stamp is the year with a directional arrow pointing to the month of the year in which the helmet was made.

- All helmets have a date of issue sticker.
- The user should record their name and date of issue in the space provided.
- Safety helmets should be inspected regularly to ensure harness is correctly fitted and secure.
- Safety helmet shell should be visually examined for cracks, gouging, fading, damage caused by impact and any degradation.
- If deemed unfit for use remove from service and replace.
- Accessories and attachments must be compatible.
- All 3M brand combinations are certified.

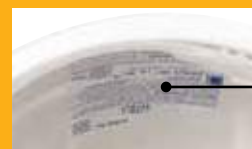

Helmet label allows date of issue and user name to be recorded.



Year and month of manufacture stamp



Helmet material stamp

# Head Protection

## Caring for safety helmets.

All Industrial Safety helmets have been designed to protect the wearer from impact and electrical hazard (up to 650V), therefore, for the helmets to provide ongoing protection the correct care of the helmet is essential.

### The design should not be modified or altered by:

- Drilling holes in the shell
- Painting the shell
- Reducing the clearance between the shell and the harness by alteration or installing objects inside the helmet
- Not using the correct harness supplied by the manufacturer
- Fitting of non-certified accessories to the helmet.

### Avoid:

- Using the helmet for other than it was designed for - seats, wheel chocks etc.
- Excessive use of chemicals such as repellents, strong cleaning agents etc.
- Wearer alteration e.g. engraving of names, painting, fitting penholders/cigarette lighters etc.
- The build up of dirt, grease etc - ensure cleaning at least weekly.
- Poor storage and unnecessary exposure to the weather and solar radiation e.g. leaving outside when not in use or storage in the back of an open vehicle.
- Holding the cap by its brim and flexing it. This will weaken the brim and cause fatigue in the safety cap.

All these have the potential to damage or weaken the helmet and cause unseen deterioration of the shell and its harness.

## Storage.

Poor storage can impact on the working life of the 3M™ safety helmet. Exposure to heat, sunlight and airborne contamination can cause premature aging. It is important to ensure safety helmets are stored in an area, locker or bag free of possible damage.

## Cleaning.

- ✓ Wash with warm soapy water
- ✓ No harsh solvents or cleaning agents
- ✓ Use dishwashing brush for stubborn marks
- ✗ Avoid petrol, paint, adhesives and aerosol sprays
- ✗ Wash harness separately. No alterations
- ✗ Visual inspection weekly. No rough treatment
- ✗ Do not place objects between shell and harness

## Mandatory head protection.

Many worksites around Australia and New Zealand have a requirement for mandatory head protection to be worn. Industries such as mining, construction, forestry and heavy engineering can expose employees to dangerous hazards and the risk of being severely injured by falling objects, knocking your head or walking into a stationary object. The wearing of a safety helmet in these working environments is essential to worker safety.



# Head Protection

## Additional considerations.

- The selection process should consider the work place operational, occupational health and safety requirements to ensure the correct helmet type and appropriate accessories are selected.
- Ensure the wearer understands the purpose/reason for the need to wear a safety helmet.
- The wearer is instructed on the fitting and care of the helmet and or accessories.
- Periodic inspection and maintenance is carried out to ensure the helmets are in good working condition and defective helmets and components or helmets that have exceeded a reasonable working life are replaced.

## Damage.

Safety helmets can endure invisible damage due to excessive exposure to sunlight, heat, solvent based paints, markers or cleaning products, the use of adhesives needs to be avoided and advice sought prior to using self adhesive labels and tapes. 3M offers reflective tape and custom printing of helmets at the time of manufacturing.

## Bump caps are not an alternative to mandatory safety helmets.

- Bump caps are effective against knocks, bumps and scalp lacerations.
- Bump Caps are ideally suited for some trades activities, domestic security, police, aviation, ground staff, transport services and auto-repair etc.

## Comfort and correct fit.

The 3M™ safety helmet range places wearer comfort at the same level of importance as features and performance.

Learning how to adjust straps and other parts on your safety helmet for a comfortable and effective fit is essential for adequate head protection and product performance.

Multiple adjustments can be made on 3M™ safety helmets to personalise fit.

In fact, there are over twenty-four variations, including adjustments to allow for forehead size either moving the headband forward, back, up and down (four-way adjustment) on the four lug suspension points.

## Ratchet.

Ratchet headband provides easier and quicker adjustment. The ratchet adjustment allows custom, on-head sizing.

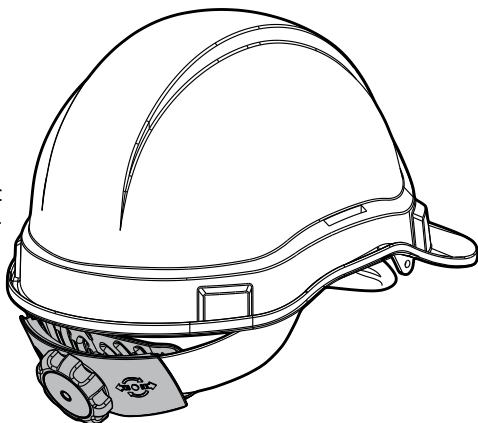

## Features.

- Fully compatible with the 3M current range of headgear and harnesses.
- No screw is needed during the assembly process, the knob tightness will be consistent.
- Easily assembled by end-user without any tool
- Increase user comfort level in the work with additional pad.
- Customize printing can be applied on the ratchet knob.
- Ratchet Adjustment indicator.

## Correct fit.

To provide adequate protection to the wearer the helmet should be a comfortable, secure fit.

- The headband size should be adjusted to a firm, but not tight fit on the wearers head.
- For wearers with small head sizes the head harness may need adjustment to provide a better balanced fit.
- The peak (cap style) for general wear should be worn at the front and the cap aligned horizontally.
- The accessories selected should attach securely to the helmet and not adversely affect the balance, comfort or the performance of the helmet. A helmet worn in conjunction with a visor holder and visor may require a ratchet headband to be fitted to the helmet to maximise fit security and balance.

## Other workplace hazards may need to be considered during the safety helmet selection process.

- High Noise (Hearing Protection) - the suitability of the industrial safety helmet to be used in conjunction with earmuffs.
- High wind areas or when used with machinery (eg bulldozer) - the use of a ratchet adjustment headband and/or a chin strap will enhance stability.
- Eye & face hazards from flying objects, heat, splashing molten metals & chemical splash etc. - use of suitable protective face and eye shields in conjunction with the helmet (Type 1, 2 or 3) and/or the use of suitable ear and neck protectors.
- Low light (tunnels, mining etc) - the use of suitable lamp attachments, cable clips, reflective tape and other visibility aides.
- Outdoor applications - the use of wide brim attachments, ear and neck protectors, top ventilation in the cap shell and fitment of suitable sweatbands as well as the use of light colours or high visibility colours.

# 3M™ SecureFit™ Safety Helmet X5000

From our proprietary design to our industry-leading innovations, the 3M™ SecureFit™ Safety Helmet is engineered by safety experts with workers in mind. The result is a revolutionary helmet design: the 3M SecureFit Safety Helmet. Comfort without compromise.

### Features and Benefits:

- Suspension system incorporates the patented Pressure Diffusion Technology.
- Ratchet suspension allows wearer to customise height and fit
- X5000 meets the requirements in both EN 12492 and the EN 397, but the requirements in these standards can not simultaneously be met. Therefore a switch in the attachment points of the chinstrap is set to one or the other. On delivery the helmet is configured for EN397
- X5500 meet the requirements in the industrial helmet standard EN 397 and are available in both a vented and a non-vented version
- Customise your fit with multiple levels of vertical adjustment
- Works with a variety of 3M faceshields, earmuffs, and other accessories
- X5000VE is 1000V approved according to the standard on electrical insulation of helmets EN 50365. The X5000VE helmets are delivered with a chinstrap



3M Order Code	Model #	Description
UU009535467	X5001VE-CE	Vented White
UU009535517	X5007VE-CE	Vented Orange
UU009535533	X5014VE-CE	Vented Green
UU009535483	X5003VE-CE	Vented Blue
UU009535525	X5012VE-CE	Vented Black
UU009535541	X5501NVE-CE	Non-vented white

### 3M™ Short Visors

3M Order Code	Model #	Description
UU009626134	X5-SV01-CE	Clear Visor AF/AS 10/CS
UU009626142	X5-SV02-CE	Gray Visor AF/AS 10/CS

### Accessories

3M Order Code	Model #	Description
UU009536036	X5-S4PTCS2	Standard 4 Point Chin Strap
UU009630326	X5-BWPD01	Black/Grey Replacement Sweat Band
UU009536069	X5-REFKIT	Reflective sticker kit for SecureFit™ Safety Helmet

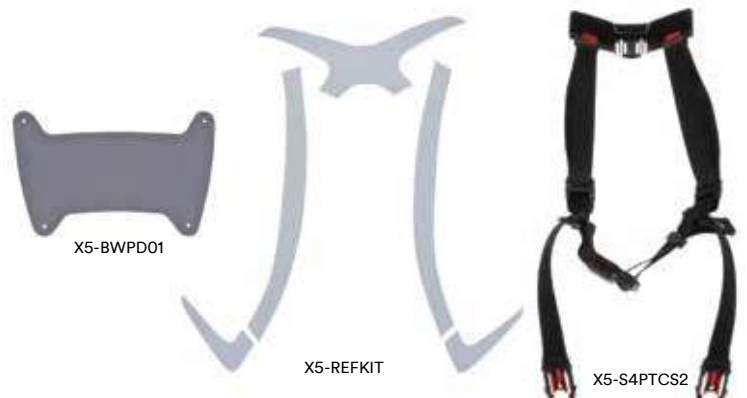

## 3M™ TA570 Safety Helmet ABS Vented

The Australian made TA570 is a vented ABS Type 1 safety helmet ideal for general industrial, construction and mining applications. The unique crown cooling vented safety helmets ensure cooler and more comfortable protection in hot humid conditions. The safety helmet design allows multiple branding and reflective tape options.

### Features and Benefits:

- ABS Type 1 vented safety helmet
- Australian made
- Unique crown cooling vents for outdoor/indoor use
- 6 point terylene harness with adjustable headband
- Replaceable Terry Towel sweatband (TA094)
- 25mm moulded slots accept all safety helmet accessories
- Polycarbonate & metal lamp bracket options available
- Ideal for general industry, construction, mining and forestry
- Certified to AS/NZS 1801:1997



3M Order Code	Model #	Description
NT070011480	TA570:BL	Vented Blue
NT070011498	TA570:FLOR	Vented Fluro Orange
NT070011506	TA570:FLYE	Vented Fluro Yellow
NT070011514	TA570:GN	Vented Green
NT070011530	TA570:OR	Vented Orange
NT070011548	TA570:RD	Vented Red
NT070011555	TA570:WH	Vented White
NT070011563	TA570:YE	Vented Yellow
NT070011647	TA570M:WH	Vented White
NT070011720	TA570RH:WH	Vented White
NT070011670	TA570RH:BL	Vented Blue
NT070011696	TA570RH:FLYE	Vented Fluro Yellow

RH = Ratchet

M= Metal Lamp Bracket

# Head Protection

## 3M™ TA560 Safety Helmet Abs

- ABS Type 1 safety helmet
- Australian made
- 6 point terylene harness with adjustable headband
- Replaceable Terry Towel sweatband (TA094)
- 25mm moulded slots accept all safety helmet accessories
- Polycarbonate & metal lamp bracket options available
- Ideal for general industry, construction and mining
- Certified to AS/NZS 1801:1997



3M Order Code	Model #	Description
NT070011316	TA560:BL	Blue
NT070011324	TA560:FLOR	Fluro Orange
NT070011332	TA560:FLYE	Fluro Yellow
NT070011365	TA560:OR	Orange
NT070011373	TA560:RD	Red
NT070011399	TA560:WH	White
NT070011407	TA560:YE	Yellow

## 3M™ TA580 Safety Helmet Polycarbonate type 2 (Heat)



3M Order Code	Model #	Description
NT070011787	TA580:WH	Unvented White
NT070011779	TA580:FLYE	Unvented Fluro Yellow
NT070011761	TA580:FLOR	Unvented Fluro Orange

## 3M™ HH40 Type 1 ABS

- HH40 Non-vented, Type 1 ABS material, durable and lightweight
- Full brim for extra sun or splash protection
- Six point 25mm webbing harness with injection moulded adjustable headband
- Customised options available: logos, reflective tape
- Accessories available: sweatband, chinstrap, headgear
- Optional model: helmet with miners lamp brackets (metal or polycarbonate)
- Available on request (minimum order quantities may apply)
- Fluro yellow and orange colours available on request (minimum order quantities apply)
- Suitable for mining, construction, transport, forestry and heavy engineering industries



3M Order Code	Model #	Description
NT070009757	HH40:WH	White
NT070009740	HH40:RD	Red
AT010703414	HH40:BL	Blue

## 3M™ TA590 Safety Helmet Polycarb (Heat)



3M Order Code	Model #	Description
NT070011845	TA590:FLYE	Vented Fluro Yellow
NT070011852	TA590:WH	Vented White

## 3M™ Safety Branded Safety Helmets

- Australian made Type 1 ABS safety helmet, for general industrial use
- Ideal for evacuation and work sites where specific employee responsibilities and clear identification is required
- Certified to AS/NZS 1801:1997



3M Order Code	Model #	Description
AT010705468	TA560R27:RD	Fire Warden Red



# Head Protection

## 3M™ HC23 First Base 3 Bumpcap

- Available in assorted colours and peak lengths
- Fashionable and lightweight providing high wearer acceptance
- Unique perforated vented shell with comfort pad
- Contoured over the ears improves compatibility with other PPE
- Machine washable fabric caps
- CE approved to EN812:A1
- Protects the head from knocks, bumps and scalp lacerations
- Must not be used for mandatory safety helmet applications
- Hi-vis options available
- 52 – 65cm head size



3M Order Code	Model #	Description
NT070009328	HC23BGELTRP	Base Bump Cap 3 Blue Grey Reduced Peak
NT070009336	HC23BLKRPLA	Base Bump Cap 3 Black Reduced Peak Clssc
NT070009344	HC23HORPCLA	Base Bump Cap 3 Hi Vis Orange Reduced Peak
NT070009351	HC23HYRPCLA	Base Bump Cap 3 Hi Vis Yellow Reduced Peak
NT070009369	HC23NBMPCLA	Base Bump Cap 3 Navy Blue Micro Peak
NT070009377	HC23NBRPLA	Base Bump Cap 3 Navy Blue Reduced Peak

## 3M™ HC36 Bumpmaster

The Bumpmaster is a wipe clean, polyethylene bump cap, designed to protect against head bumps and scalp lacerations. Suited to applications where cleanliness in conjunction with bump protection are the prime considerations, eg. in the food preparation industry.



3M Order Code	Model #	Description
NT070009401	HC36:WH	White
NT070009419	HC36:YE	Yellow
NT070009385	HC36:BL	Blue

# Head Protection

## 3M™ Wide Brim and Neckflap

- Accessory to any safety helmet
- Provides sun protection for the face and neck
- Ideal for outdoor workers specifically construction, forestry, electrical maintenance, mining, oil and gas exploration and general industry



3M Order Code	Model #	Description
NT070011217	TA173:OR	Orange
NT070011209	TA173:NA	Navy

## 3M™ Balaclava

- Hook and loop attachment lugs – easy fitting to helmet harness
- Integrated neckflap design for added warmth
- Balaclava rotates with helmet for improved safety and helmet stability
- Suitable for forestry, construction, plant operators, cold storage, freezer or cold weather workers



3M Order Code	Model #	Description
NT070011233	TA179	Balaclava For Use Under Helmet

## 3M™ Visor Holders for Safety Helmets



VV765\*



VH500P

VH500



3M Order Code	Model #	Description
AT010707381	VH500	Nylon Visor Holder For TA500 Helmet Visor
AT010707399	VH500P	Nylon Peaked Visor Holder For TA500
AT010659731	VV765	Aluminium Visor Holder For TA500 Helmets

\*VV765 is not made in Australia.

## 3M™ Sweatbands



TA094



TA095

3M Order Code	Model #	Description
AT010700691	TA094	Sweatband Terry Towelling (7)
AT010701343	TA095	Sweatband Lambswool For Helmets

## 3M™ Safety Helmet Accessories



TA170



TA598



TA597



3M Order Code	Model #	Description
NT0700011191	TA170	Cotton Neck Flap White
NT070011225	TA175	Chinstrap For TA500 TA400 Series Helmets
NT070011241	TA180	Reflective Tape Kit For Helmets
NT070011308	TA497	Replacement 6 Point Harness For TA400
NT070011894	TA597	Replacement 6 Point Harness For TA500

## Head Protection

# 3M™ Peltor™ G2000 Helmet

Attractive design and excellent protection is the best way to summarise the Peltor G2000 helmet. The helmet goes well beyond the requirements for formal testing and is comfortable with its low back and relatively low profile.

It was designed to accommodate additional accessories, visor and hearing protection. Certified to EN397. Tested and complies with AS/NZS1801.

### Features and Benefits:

- **Ventilation** - Comfort and good ventilation are a must, particularly in warm environments. The G2000 allows free airflow between the helmet and its harness. Combined with ventilation inlet in the top of the helmet, this helps to increase wearer acceptance
- **Peltor™ Uvicator™ Sensor** - The disc indicates when it's time to replace your helmet
- **Neck protection** - Extended edge on the back of the helmet provides extra protection for the sensitive neck area
- **Headband** - This important feature determines how steadily the helmet sits on the head. Easy to adjust
- **Attachment point for accessories** - An adjustable snap attachment in the balance point of the helmet to allow simple attachment of accessories, such as muffs, headsets and visors
- **Optimal profile for ear muffs** - The G2000 features a special profile design to enable helmet mounted ear muffs to achieve optimal fit and maximum adjustability for individual needs.



3M Order Code	Model #	Description
XH001675012	G2000NUV-GP	3M™ Peltor™ G2000 Helmet Green
XH001675020	G2000NUV-GU	3M™ Peltor™ G2000 Helmet Yellow
XH001675046	G2000NUV-RD	3M™ Peltor™ G2000 Helmet Red
XH001675053	G2000NUV-VI	3M™ Peltor™ G2000 Helmet White
XH001675244	G2000NUV-GB	3M™ Peltor™ G2000 Helmet Hi Viz



# Face Protection

Faceshields are a versatile eye/face protector and are used in many industries to protect users against flying particles, liquids, chemical and molten splashes, radiant heat and glare. The 3M™ visors are manufactured from Polycarbonate (medium and high impact), Thermoguard+ (high impact and heat, chemical, molten metal and hot solids protection) and mesh (nylon and metal - low to medium impact depending on mesh visor selected). Visors can be fitted to 3M™ browguards or visor holders for use with the 3M™ brand safety helmets. 3M™ recommends the use of safety eyewear when wearing a visor system.

# Face Protection.

At 3M™, we help employers deal with safety barriers between workers and the jobs that need to get done. That's the motivation behind our high-performance line of combination systems. These integrated systems provide multifaceted protection in one convenient package. Each component is designed for durability and ease of use – and together, they provide advanced protection from a leader in safety. Consider this system for workers who clear vegetation with power tools.

The 3M™ brand is synonymous with innovation and technical precision. We're at the leading edge of head and face protection because we have our ear to the ground. We understand the nuanced needs of different market segments, and we're constantly elevating the standards of personal safety for a wide range of industries.

We design and produce hard hats, faceshields, combination systems and accessories to meet a diverse spectrum of needs. We're committed to producing consistently reliable, user-friendly products



# Face Protection

## Browguards & Visors Complete

- Low to high impact protection. Meet the impact protection requirements in accordance with AS/NZS1337.1
- Ratchet headgear adjustment for comfort
- Fits all range of visors
- Replaceable Terry Towel Sweatband (TA094)
- Wipe down finish
- Suitable for general industry against medium to high impact, heat and chemical hazards

### VC107

- Low to high impact protection
- Ratchet adjustable headband
- Wide flare 1mm polycarbonate visor with chinguard for extra neck and face protection
- Visor dimensions: 400(w) x 175(h) mm
- Friction pivoting system for lifting and lowering
- Protect wearer against flying particles, liquid, chemical, molten splashes, radiated heat and glare
- Suitable for work such as grinding and disc cutting, lead jointing, metal cleaning and plating, chemical processing, liquid splash and gauging



VC105



VC107



3M Order Code	Model #	Description
NT070012090	VC105	Browguard and Visor Complete Kit
NT070012108	VC107	Browguard Visor and Blue Chinguard Kit
NT070012272	VV848	Replacement Clear Polycarb Visor VC105

## 3M™ Clear Unbound Economy Visors

- 1mm thickness provides medium impact protection
- 1mm thickness provides high impact protection
- Polycarbonate visors have a safe operating temperature of 105°C
- Suitable for resistance to impact and waterbased liquids



3M Order Code	Model #	Description
NT070012249	VV730	1mm Polycarb Clr 200mm x 385mm Visor

## 3M™ Budget Faceshield Complete

- Medium impact protection
- Economical Faceshield
- Polycarbonate visor
- Resistant to medium impact particles and water-based liquids e.g. biological, acids, weak solvents
- Suitable for general use or for school laboratories or medical purposes



3M Order Code	Model #	Description
AT010707449	VV230	Budget Faceshield Complete With Visor

## 3M™ Browguard

High impact glossy nylon shell. Lightweight and comfortable. Ratchet adjustable headgear. Replaceable Terry Towel Sweatband (TA094). Suitable for all general industrial and high heat applications. Visors purchased separately



VV997



TA094\*



WA182



3M Order Code	Model #	Description
NT070012363	VV997	Browguard Only With Ratchet Headgear
NT070011183	TA094	Sweatband Terry Towelling (7)

\*TA094 is not made in Australia.

## 3M™ Visor Holders for Safety Helmets



VH500



VV765\*



2010892



3M Order Code	Model #	Description
NT070012116	VH500	Nylon Visor Holder for TA500 Helmet Visor
NT070012124	VH500P	Nylon Peaked Visor Holder for TA500
NT070012256	VV765	Aluminium Visor Holder for TA500 Helmets
NT070008536	2010892	Visor Post L Profile T25 Grp

\*VV765 is not made in Australia.

## 3M™ Clear 1mm Polycarbonate Visors

- 1mm thickness provides high impact protection
- Polycarbonate visors have a safe operating temperature of 105°C
- Suitable for resistance to impact and waterbased liquids



VV848



3M Order Code	Model #	Description
NT070012272	VV848	Replacement Clear Polycarb Visor VC105
NT070012280	VV854	1mm Visor VV854, 200mm x 400mm. High impact
NT070012348	VV925	1mm Polycarb 250mm x 400mm Visor Flared

# Face Protection

## 3M™ Clear Thermotuff+ Visors

- Thermotuff+ visors have a safe operating temperature of 125°C
- Thermotuff+ visors provide high impact, radiant heat and chemical splash protection



VV875



3M Order Code	Model #	Description
AT010707712	VV876	1mm Thermotuff 200mm x 400mm Visor Flared
AT010707746	VV882	1mm Thermotuff 250mm x 400mm Visor Flared

## 3M™ Green Shade 5 Visors

- Shade 5 visors gives protection against liquid splash, high glare and ultra violet radiation.
- Approved for use for gas and braze welding operations



3M Order Code	Model #	Description
NT070012322	VV901	1mm Thermotuff Shd 5 200mm x 300mm Visor
NT070012330	VV904	1mm Thermotuff Shd 5 250mm x 400mm Visor Flared
NT070008346	VV927:5	1mm Polycarb Shd 5 200mm x 400mm Visor Flared

## 3M™ Green Shade 2 Visors

- Suitable for outdoor glare
- UV and anti-scratch resistant
- Provides high impact protection



3M Order Code	Model #	Description
AT010707654	VV822	1mm Thermotuff Shd 2 200mm x 400mm Visor
AT010707662	VV824	1mm Thermotuff Shd 2 250mm x 400mm Visor

## 3M™ Chinguard Visors

- High impact resistant
- Provide additional chin and upper chest protection
- Available in different materials to suit various applications



VV501



VV801

## 3M™ V5 Face shield carrier

The V5 Face shield carrier feature makes it quick and easy to combine the face shield to the face shield holder.

- Compatible only with 5F-11C & 5B mesh visor
- Requires either a P3E 30mm or a P3G 24mm earmuff slotted adapter to attach to a hard hat



3M Order Code	Model #	Description
XA007704084		V5 Linkage System For Helmet 10/Case

## 3M™ Aluminium Mesh Visor

Meets the impact requirements of AS/NZS 1337.2. Low Impact.



3M Order Code	Model #	Description
NT070012132	VM820	Aluminium Mesh Visor VM820, 150mm x 385mm



VV515



VV502



VV518



3M Order Code	Model #	Description
NT070012140	VV501	1mm Polycarb Clear 230mm x 400mm Chinguard
NT070012157	VV502	1mm Polycarb Gold 230mm x 400mm Chinguard
NT070012173	VV511	1mm Thermotuff Clear 230mm x 400mm Chinguard
NT070012199	VV515	1mm Thermotuff Shade 5 230mm x 400mm Chinguard
NT070012207	VV520	1.5mm Polycarb Clear 175mm x 400mm Chinguard

# Face Protection

## Headgear Combo Forestry

The 3M™ Headgear G500 provides a versatile and comfortable solution for wearers who require both face and hearing protection.



3M Order Code	Model #	Description
XA007703862	G500V5CH510-OR	Headgear Combo Forestry 3M strd

## Headgear Combo Industrial

The 3M™ Headgear G500 provides a versatile and comfortable solution for wearers who require both face and hearing protection.

With special design features making it easy to combine the headgear with other 3M safety products such as face shields, passive earmuffs or communication headsets and eyewear.



3M Order Code	Model #	Description
UU001471117	G500V511H510-GU	Headgear Combo Industrial 3M strd

## Lumberjack Combo

The Peltor lumberjack system combines head, face and hearing protection. This unit was developed for the logging and gardening industry. It has a uniquely designed front visor shield which helps eliminate sawdust and rain from falling between the mesh screen and hard cap. The mesh visor and earmuffs can be swiveled both up or down. The rain guard protects your neck from debris and rain.



3M Order Code	Model #	Description
XH001655758	G2000CUOR31V4-C-01	Lumberjack Combo

## Sweat Band HYG50

Replaceable Plastic Sweatband which is suitable for all general industrial use with Peltor™ HeadGear G500.



3M Order Code	Model #	Description
XA007703854	HYG50	Sweat Band - Plastic



# Face Protection

## 3M™ Peltor Mesh Visor V4B

The V4B Visor system is extremely lightweight and non-conductive, which is a necessary feature in some environments such as working with electric power cables. Made of black polyamide with a matt finish, system includes visor, helmet frame and linkage kit, which will attach to either a P3E 30mm or a P3G 24mm slotted adaptor. Designed to be used with or without Peltor earmuffs. Meets the impact requirements of AS/NZS 1337.2 Low Impact.



3M Order Code	Model #	Description
XH001650239	V4B	Peltor Mesh Visor - Nylon

## 3M™ Peltor Clear Visor Large V4K

The V4K provides greater protection area against splashes, high speed particles and debris. Excellent high impact-resistant colourless visor, made from high quality polycarbonate. Visor includes helmet frame and cap attachment. Lets through 95% of light. UV filter Approved for protection against short circuit electric arc, Molten metals and hot solids. Meets the impact requirements of AS/NZS 1337.1 High Impact.



3M Order Code	Model #	Description
XA007702328	V4K	Clear Visor Polycarb Large CECE

## 3M™ Face Shield Clear 5F-11 PC

The polycarbonate face shield 5F-11 (compatible with the V5 shield carrier) provides increased protection against high speed particles (190m/s). It is scratch resistant and anti-fog treated on both sides for the maximum field of view. Compatible with the V5 Face shield carrier. Meets the impact requirements of AS/NZS 1337.1 High Impact.



3M Order Code	Model #	Description
UU001470994	5F-11 PC	Field Shield Clear - AS+AF

## 3M™ 5B Mesh Face Shield

High quality product that provides protect against impacts from the front and side. Firm and sturdy for improved product life. The 5B mesh face shield is lightweight, sturdy, have increased robustness for protection against high speed particles (45m/s), without compromising the field of view and user comfort. Compatible with the V5 Face shield carrier.



3M Order Code	Model #	Description
XA007703870	5B	Mesh Face Shield Plastic

## 3M™ Peltor Mesh Visor V4G

Design ensures excellent strength and stability. This visor, made of steel with a matt finish, is for extremely harsh working environments. System includes visor, helmet frame and linkage kit, which will attach to either a P3E 30mm or a P3G 24mm slotted adaptor. Designed to be used with or without Peltor earmuffs. All mesh visors meet the impact requirements of AS/NZS 1337.2:2012 (low impact) and meet the requirements for increased robustness (S marking). Standards/ Approvals AS/NZS 1337.2 Low Impact



3M Order Code	Model #	Description
UU001607181	V4G	Peltor Mesh Visor - Metal



# Eye Protection

The portfolio of 3M™ Eye Protection products promises quality eyewear that provides an optimal balance of comfort, protection and design. 3M™'s Engineers have worked hard to ensure that the level of comfort and style matches the standard of protection offered. The 3M™ portfolio offers the highest level of optical class. A broad range of eyewear products include durable anti-scratch and convenient anti-fog coatings.

# About the range.

Eye Protection products are used in many industries to protect against flying particles, liquids, chemicals, molten metals, radiated heat and glare. The 3M™ range of safety spectacles and goggles offer the user protection from eye hazards including medium impact flying fragments.

Our 3M™ safety spectacles and goggles can be used in conjunction with other Personal Protective Equipment products to give you added protection in different situations.

The 3M™ eye protection portfolio offers an unrivalled range of products for companies looking for comfortable and high-quality solutions to meet a variety of industrial applications.



### **Style.**

Style is a critical factor when it comes to raising the acceptance of the user to wear personal protective equipment (PPE). 3M™'s range of eyewear gives you a variety of modern and stylish products from which to choose.

### **Protection.**

The 3M™ range of eyewear offers high quality optics. Most of the 3M™ glasses and goggles offer reliable UV protection and all are tested and comply with AS/NZS1337.1

### **Comfort.**

Many of our products come with adjustable features and soft materials in points of contact in order to improve fit and comfort to accommodate different face sizes and shapes.

### **Compatibility.**

Eye protection often needs to be worn in conjunction with other protective equipment and it is essential that comfort and fit with other PPE is maintained. Most of the eyewear and goggle ranges can be used in combination with respiratory and hearing protection by 3M™. Compatibility with other PPE will be subject to a number of variable factors which requires the employer and end user to determine an appropriate selection depending on individual needs.

## Human eye

**The Cornea** in direct contact with an external environment, plays an essential part in the transmission of light rays. There are more nerve endings in the cornea than anywhere else in the body.

**The Pupil** (light controller), situated in the middle of the iris, works like the diaphragm of a camera. Its diameter changes in accordance with the light levels.

**The Lens** allows focusing (near vision, far vision) thanks to a control muscle. With age this muscle loses power and impacts near vision (presbyopia). The lens can lose its transparency due to exposure to IR (infrared light) and UV (ultraviolet light), resulting in loss of vision (cataract).

**The Retina** is where all light beams converge; it transmits all information through the optic nerve to the brain in order to create your vision. Burned retina cells are lost forever which causes irreversible loss of vision.

### Industrial hazards for the eyes:

- Mechanical hazards: dust, shock, solid particles.
- Thermal hazards: hot liquid, molten splash, flames.
- Chemical or Biological hazards: splashes of acids, solvents, alkalis, infected blood.
- Radiation hazards: ultraviolet, infrared, visible light, laser.
- Electrical hazards: direct contact, short-circuit electric arc.

### Facts on eye damage:

Every day worldwide more than 600 workers suffer from eye injury simply because they do not wear protective eyewear.

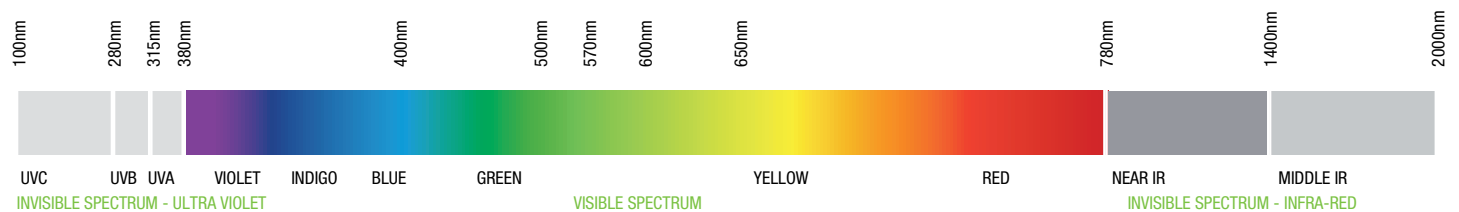
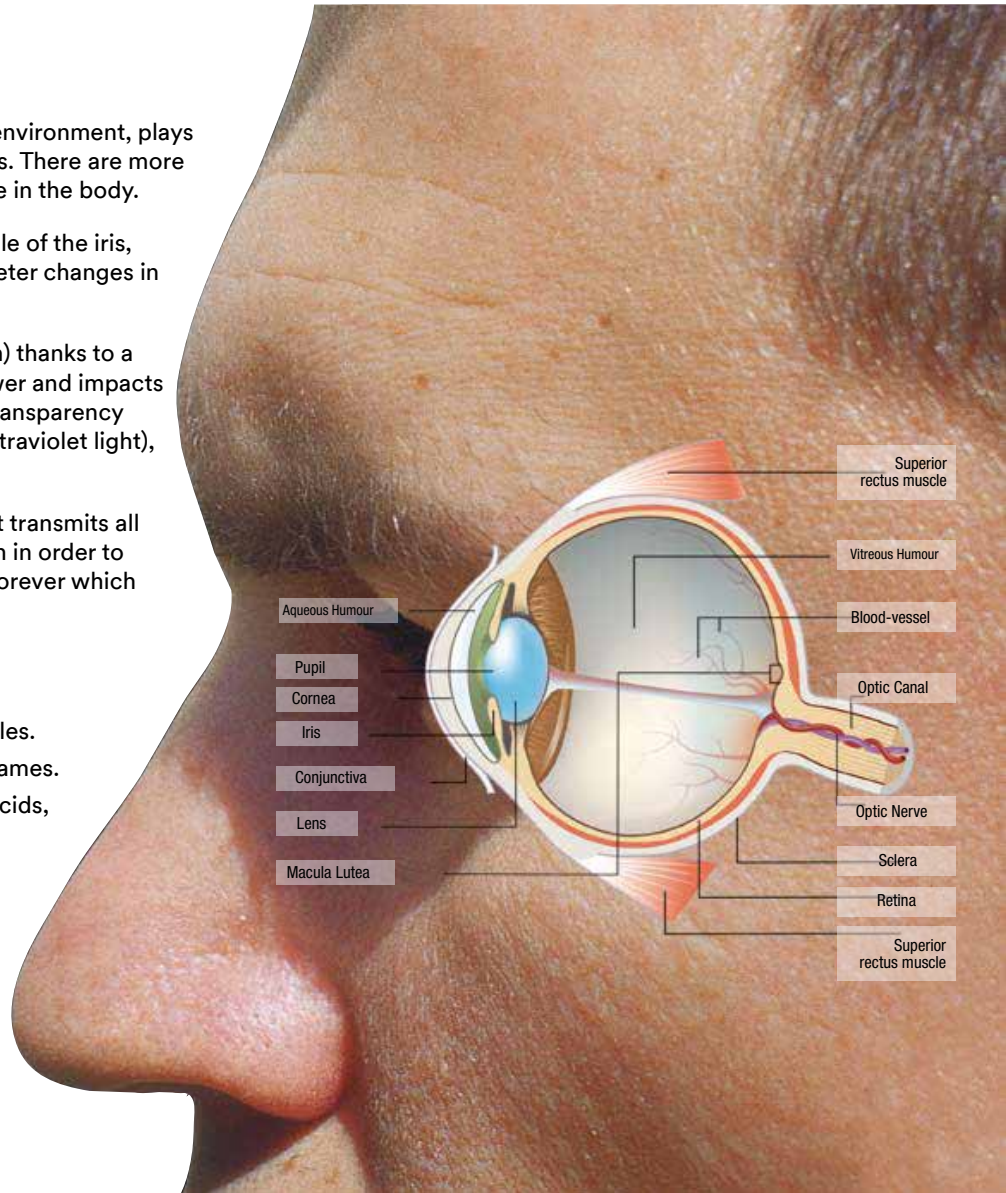

### Potential Effects from Exposure to Light and other Radiation

	UVC 100 to 280nm	UVB 280 to 315nm	UVA 315 to 380nm	BLUE LIGHT 380 to 480nm	VISIBLE LIGHT 380 to 780nm	NEAR IR 780 to 1400nm	MIDDLE IR 1400 to 2000nm
<b>Cornea</b>	Conjunctivitis Partial Blindness	Conjunctivitis Partial Blindness	Conjunctivitis Partial Blindness				
<b>Lens</b>	Conjunctivitis	Cataract Premature Ageing	Cataract Premature Ageing			Cataract	Conjunctivitis Partial Blindness
<b>Retina</b>	Conjunctivitis			Partial Blindness Photoreinitis	Vision Problems Discontinuous Vision	Retinitis Pigmentosa	

# Protection all the way.

Eyewear injuries happen when you least expect them.  
Be prepared.

We believe that health and safety are the priorities in any working environment, and that greater comfort and modern styles improve worker compliance with regulatory requirements for protective eyewear.

Therefore, we take care in adding comfort features where they are needed most, such as heavy contact areas like nose bridges and temple tips. The materials we choose to provide better comfort are designed to be durable to last and soft to the touch. We are also continually working on new coatings, new materials and new designs to bring the latest technology, innovation and fashion into our protective eyewear line.

### What contributes to eye injuries at work?

- **Not wearing eye protection.** Nearly three out of every five workers injured are not wearing eye protection at the time of the accident.
- **Wearing the wrong kind of eye protection for the job.** 40% of the injured workers were wearing some form of eye protection when the accident occurred. However, these workers were most likely to be wearing protective eyeglasses with no side shields.

### What causes eye injuries?

- **Flying particles.** Almost 70% of accidents resulted from flying or falling objects or sparks striking the eye. Injured workers estimated that nearly three-fifths of the objects were smaller than a pinhead. Contact with chemicals caused one-fifth of the injuries.

### Where do accidents occur most often?

- **Craftwork.** Potential eye hazards can be found in nearly every industry, more than 40% of injuries occurred among craft workers, like mechanics, repairers, carpenters and plumbers.
- **Industrial equipment operation.** Over a third of the injured workers were operators, such as assemblers, sanders, and grinding machine operators. Almost half of these injured workers were employed in manufacturing.

### How can eye injuries be prevented?

- **Always wear effective eye protection.** AS/NZ standards require that employers provide workers with suitable eye protection. To be effective, the eyewear must be of the appropriate type for the hazard encountered and properly fitted.
- **Better training and education.** Workers injured while not wearing protective eyewear most often said they believed it was not required by the situation. Even though the vast majority of employers furnished eye protection at no cost to employees, about 40% of the workers received no information on where and what kind of eyewear should be used.
- **Maintenance.** Eye protection devices must be properly maintained. Scratched and dirty devices reduce vision, cause glare and may contribute to accidents. Scratched or damaged eyewear should be replaced immediately.



# How to pick the right tinted safety glasses for your job.

Safety glasses come in numerous shapes and styles, but do you know how to choose the right tinted safety glasses for your job? Safety glasses are available in many different tints that serve many different purposes, depending on the job at hand and your environment. Tinted safety glasses can help reduce glare, reflect bright light, absorb harmful light, including UV and infrared (IR), and even increase contrast in your field of vision. We're discussing the reasons why selecting the right lens for your specific application is so important and sharing what you need to know about popular lens tints.

## Why does choosing the right lens matter?

### Safety

The top reason why lens tint matters comes down to safety. When you're wearing the right colour of tinted lenses, not only will this help protect your eyes from the hazards of the job at hand, your eyes can feel less fatigued from strain that can result from different working conditions. This can result in fewer instances of workers removing eyewear from their face due to discomfort, thereby keeping them safer. It's also important to look for eyewear that meets AS/NZS 1337.1:2010, which means it has passed impact testing and other safety requirements that can help protect your eyes.

### Health

The right eyewear can help reduce light sensitivities, eye strain and headaches for wearers. Polycarbonate lenses contain UVA and UVB coatings, which help protect eyes from light conditions that can damage them and increase a wearer's risk of developing eye disease, including cataracts. Different people have different needs, and choosing the right lens tints can be beneficial to a worker's health.

### Productivity

Certain lens tints provide contrast and can help workers see fine details better and more easily. This can help workers complete certain tasks more accurately and more quickly.

### Comfort

This is one of the most important considerations when choosing a lens tint – and personal protective equipment (PPE) in general! When PPE is comfortable, workers are more likely to wear it and keep it on. This is why 3M produces so many different styles of safety eyewear and encourages sampling different pairs of safety glasses to see what will work for a worker's individual face size and shape. To help objectively measure comfort and fit, we specially developed the 3M™ Eyewear Fit Testing System to help measure gaps and fit around the eyes to promote optimal protection and comfort.

## 3M™ Protective Eyewear Lens Tints.

### Clear

It likely isn't a surprise that clear safety glasses are the most popular choice of safety glasses. Luminance transmittance is the highest with clear safety glasses, at 93%. This means that a clear lens allows for the maximum amount of light to pass through the lens, which is beneficial for tasks requiring well-lit environments. Safety eyewear lenses made with polycarbonate will naturally absorb approximately 99% of UVA and UVB light, which provides additional protection to the user. All 3M polycarbonate lenses have been tested to the newest AS/NZS 1337.1:2010 to ensure compliance and safety. Safety glasses with clear lenses are best for everyday use and are appropriate for a wide variety of applications and uses.



# Protective eyewear.

## Polycarbonate lens selection guide

This Polycarbonate Lens Selection Guide will help you understand the need for different colour lenses and lens types for industrial applications. It will also help you determine what type of lens is best for your application and environment. There are many lens options other than Clear, Grey and Mirror. When choosing a lens, the basic “rule of thumb” is to consider colour opposites.

Lens Colour/Type	Lens Properties/Use	Suggested Applications/Environments
Clear	Maximum amount of light reaches the eye for good vision and acuity.	General everyday eye protection.
Grey, Bronze	Reduces brightness and glare from the sun.	Mainly for outdoor daytime use as in typical sunglass use.
Mirror & Coloured Mirror	Reduces brightness and glare from the sun.	Mainly for outdoor daytime use as in typical sunglass use.
Indoor/Outdoor	Reduces brightness and glare when working both indoors and outdoors.	For tasks requiring frequent movement indoor to/from outdoor. Loading docks, forklift drivers, construction or similar jobs.
Photochromic	Reduces brightness and glare from the sun and indoor lighting.	Lens darkens when outside and lightens when inside. Do not use for frequent indoor to/from outdoor movement.
Polarized	Reduces brightness and glare from the sun.	Exceptional for reducing reflective glare. Mainly for outdoor use.
Yellow/Amber	Increases contrast, reduces haze from blue lighting, excellent UV protection.	Good for inspection tasks and hazy, overcast or foggy days. Never use for night driving.
Filter Shades, Green & Grey	Reduces ultraviolet, visible and infrared radiation.	Predominately used for gas welding, cutting, brazing and soldering, metal making, furnace work and open flames.



Mirror & Coloured Mirror



Indoor/Outdoor



Photochromic



Yellow/Amber



Clear



Polarized



Filter Shades Grey & Green



Grey, Bronze

# Lens markings.

Markings on eye protectors are a requirement for certification. It assists users in identifying their intended use.

They are identified by the following:

Standard	Lens Marking	Explanations
AS/NZS 1337.1:2010	I = Medium Impact O = Outdoor/Indoor (untinted or amber)	OUTDOOR UNTINTED (FOR INDOOR AND OUTDOOR USE) These protectors are intended for indoor and outdoor use where no optical radiation hazards exist other than solar radiation.
	I = Medium Impact (outdoor tinted, smoke, brown or photo chromatic)	OUTDOOR TINTED These protectors are intended for outdoor use where no optical radiation hazards exist other than solar radiation. They are intended to provide adequate protection against sun glare and ultraviolet radiation from the sun.
	Filter Lenses (green shade 3)	These filter lenses are intended for welder assistant use and provide limited protection against ultraviolet. Infrared and visible radiation. Not suitable for electrical welding.

Impact protection is determined by the metres per second in which a projectile travels. A ballistic test rig fires either a 6.00mm or a 6.35mm projectile ball at speeds from 12m, up to 190m per second dependent on which size projectile is used.

Standard	Rating	Ball Speed		Impact Protection Situations	Type of Protector
		6.00mm	6.35mm		
AS/NZS 1337.1:2010	Low Impact	12m/sec	12m/sec	Hammering, handling wire, brick chipping by hand	Spectacles
AS/NZS 1337.1:2010	Medium Impact	40m/sec	40m/sec	Grinding, machining metals, woodworking	Spectacles, Eyeshields or lightweight visor systems
AS/NZS 1337.1:2010	High Impact	120m/sec	110m/sec	Concrete cutting, high speed disc grinding, metal cutting	Visor systems only
AS/NZS 1337.1:2010	Extra High Impact	190m/sec	175m/sec	Abrasive shot blasting, ballistic, military, electrical maintenance	Visor systems only

Australian/New Zealand Standards AS/NZS 1336:2014 is an excellent reference document and provides assistance. Medium impact safety spectacles provide protection from medium energy flying particles. For more information on tinted lenses and compliance testing to AS/NZS 1067 (sunglass standard) contact 3M.



# Features selection guide.

	Lens Tints or Shades											
	Medium Impact	Clear	Grey	Smoke	Brown	Green	Amber	Sunset	Blue	Shade 3	Shade 5	
<b>SAFETY EYEWEAR</b>												
3M™ SecureFit™ Protective Eyewear 400 Series	✓	✓	✓									
3M™ SecureFit™ 200 Series	✓	✓	✓									
3M™ Solus™ 1000 Series	✓	✓	✓									
3M™ Helios Series	✓	✓		✓	✓		✓	✓				
3M™ CrackerJack	✓				✓							
3M™ Wasp Series	✓	✓		✓				✓				
3M™ Savannah Series	✓	✓		✓	✓							
3M™ Wolf Series	✓	✓		✓			✓		✓			
3M™ Ecko Series	✓	✓		✓								
3M™ Buster Series	✓	✓		✓			✓		✓	✓	✓	
3M™ Bark Hut Series	✓	✓		✓		✓						
3M™ 2700 Series	✓	✓										
3M™ 2720 Series	✓	✓										
3M™ Lexa™ Series	✓	✓	✓									

# Eye Protection

		Lens Coatings						Comfort				Adjustability		
Blue Blocker	I/O Mirror	Anti-Scratch Lens	Anti-Fog Lens	Polarized	UV Protection	Scotchgard™ Coated	Anti-Static	Soft Nose Bridge	Soft Temple Tips	Pressure Diffusion Temple Technology	Dust Guard	Gasket	Replacement Strap	
	✓							✓	✓	✓		✓		
									✓					
						✓		✓					✓	
		✓					✓	✓			✓			
		✓	✓		✓									
		✓	✓					✓						
			✓		✓						✓			
		✓	✓		✓									
✓				✓	✓	✓					✓			
			✓					✓						

# 3M™ SecureFit™ Protective Eyewear 400 Series

Advanced Technology. 3M™ SecureFit™ Protective Eyewear self-adjusts to the individual wearer, providing comfort that lasts all day.

3M™ SecureFit™ Protective Eyewear 400 Series comes with a variety of features, because having options in protective eyewear can be critical. Workers can choose from several lens coating options, including 3M™ and features like a removable foam gasket that combines with Pressure Diffusion Temple (PDT) Technology to create a secure and comfortable fit.

## Features and Benefits:

**Polycarbonate lenses** absorb 99.9% of UVA & UVB. Meets the requirements of AS/NZS 1337.1:2010.

**Removable foam insert** helps keep debris out of your eyes while providing comfort and cushioning.

**Soft, adjustable, one-piece nose bridge** for an individual comfortable fit.

**Dual-injected, padded temple touchpoints** for added comfort over the ears.

**Motion-inspired, contoured piping** in a bold, modern color palette for an infusion of style and cushioning.

**Self-adjusting 3M™ Pressure Diffusion Temple Technology** ensures a comfortable and a secure fit and prevents slippage.

3M Order Code	Model #	Description
70071676368	SF401AF-AS	Polycarbonate. Clear Lens.
70071695426	SF402AF-AS	Polycarbonate. Grey Lens.
70071695434	SF410AS-AS	Polycarbonate Indoor/Outdoor Mirror Lens.

# Eye Protection

## 3M™ SecureFit™ 200 Series

3M™ SecureFit Protective Eyewear features 3M's proprietary self-adjusting Pressure Diffusion Temple Technology – a scientific advancement that helps diffuse pressure over the ear, enhancing frame comfort while at the same time ensuring a secure fit across diverse workforces.



Medium Impact

3M Order Code	Model #	Description
70071676269	SF201AF-AS	Clear Lens
70071695509	SF202AF-AS	Grey Lens

## 3M™ Helios

Stylish and lightweight. Multiple lens coating options. Contoured nine base anti-static lenses provide excellent fit and coverage. Flexible, vented, pillow-padded, co-moulded side arms for comfort. Dielectric no metal components. Clip on/off dust guard improves cheek to spectacle seal.



Medium Impact

3M Order Code	Model #	Description
NT070010573	S9151	Black Red Vpp5 Clear Lens
NT070010581	S9152	Black Red Vpp5 Smoke Lens
NT070010599	S9155	Black Grey Hcaf Brown Lens

## 3M™ Solus™ 1000 Series

Slim frame with a stylish and modern look. Strong PC lenses. Lightweight with soft cushioning on nose bridge and padding on temples for increased comfort and stability and when worn.



Medium Impact

3M Order Code	Model #	Description
70071676533	S1201SGAF-AS	With Scotchguard™ Anti-fog coating. Green/Black PC. Clear Lens
70071676541	S1202SGAF-AS	With Scotchguard™ Anti-fog coating. Green/Black PC. Grey Lens
70071694551	SOLUS-FOAM	Replacement Foam Gasket
70071694569	SOLUS-STRAP	Replacement Strap

## 3M™ Bark Hut

High fashion matt black frame. Lightweight and extremely comfortable. Robust and flexible frame. Hard coat anti-fog (HCAF) coating on selected models. 100% UV protection for outdoor use. Suitable for use with cutting, non hazardous liquids, lathe work, dust, sawing, chipping, riveting, glare and solar radiation. Clip on/off dust guard for dusty working environments.



Medium Impact

3M Order Code	Model #	Description
NT070010755	SNN007BB	Blue Blocker Hc Lens Spec
NT070010763	SNN007C	Clear Hcaf Lens Spec
NT070010771	SNN007CDG	Clear Hcaf Lens Spec Dust Guard
NT070010789	SNN007GP	Smoke Graduated Pol Hc Lens Spc
NT070010797	SNN007S	Smoke Hcaf Lens Spec
NT070010805	SNN007SDG	Smoke Hcaf Lens Spec Dust Guard
NT070011159	SXDG007	Spec Dust Guard

# Eye Protection

## 3M™ Wasp

Stylish and lightweight. Multiple tints options. Contoured nine base anti-static lens. Excellent fit and coverage. Adjustable spectacle strap available. Anti-scratch/anti-fog lens coating.



Medium Impact

3M Order Code	Model #	Description
NT070010391	S0131	Polycarbonate Hcaf Clear
NT070010409	S0132	Polycarbonate Hcaf Smoke
NT070010417	S0133	Polycarbonate Hcaf Sunset

## 3M™ Wolf

Fashionable sports style. Snug one piece lens. 100% UV protection for outdoor use. Anti-scratch lens increases durability. Clear, smoke, blue mirror, amber lenses.



Medium Impact

3M Order Code	Model #	Description
NT070010920	SNN310	Wolf Smoke Lens Spec
NT070010946	SNN330	Wolf Amber Lens Spec
NT070010888	SNN300	Wolf Clear Lens Spec

## 3M™ Savannah

Lightweight polycarbonate spectacle frame. Wrap-around style with flexible side arms and temple grips. Medium impact protection. 100% UV protection for use outdoors. Anti-scratch lens increases durability. Anti-fog (clear only) lens prevents fogging in humid conditions. Suitable for general industry including fabrications, manufacturing, mining and laboratory work



Medium Impact

3M Order Code	Model #	Description
NT070010904	SNN301C	Clear Af Lens Spec
NT070010912	SNN301S	Smoke Lens Spec
NT070010896	SNN301B	Brown Lens Spec

## 3M™ Ecko

Ultra lightweight disposable spectacles. One piece wrap-around sports style. Medium impact protection. Low cost. 100% UV protection for use outdoors. Anti-scratch lens increases durability. Suitable for general industry including mining, construction, laboratory workers



Medium Impact

3M Order Code	Model #	Description
NT070010862	SNN170C	Ecko Clear Lens Spec
NT070010870	SNN170S	Ecko Smoke Lens Spec

## 3M™ Buster

Fashionable, lightweight and comfortable safety spectacles. Unique floating lens with excellent coverage. Medium impact protection. 100% UV protection for use outdoors. Anti-scratch lens increases durability. Suitable for general industry including manufacturing, engineering, workshops and indoor/outdoor industrial environments



Medium Impact

3M Order Code	Model #	Description
NT070010847	SNN101C	Clear Af Lens Spec
NT070010854	SNN101S	Smoke Lens Spec
NT070010821	SNN101A	Amber Af Lens Spec
NT070010839	SNN101BM	Blue Mirror Lens Spec
NT070010813	SNN101:3	Shade 3 Lens Spec

# Eye Protection

## 3M™ 2720 Series

Low profile for comfort with high levels of protection



Medium Impact

3M Order Code	Model #	Description
70071649522	2720-00000-100AS	Blue Frame/Clear Lens in Polybag

## 3M™ Fahrenheit™ Goggle Series

Modern, slim-line and lightweight design for excellent fit. Aerodynamic shape with cylindrical lens for 180 degree distortion-free vision. Indirect ventilation system to prevent fog, liquids and dust. Lens absorbs more than 99% UV.



3M Order Code	Model #	Description
70071531621	40170-00000	Polycarbonate Clear Lens
70071531639	40171-00000	Polycarbonate Clear Lens
70071531647	40172-00000	Acetate Clear Lens
70071531654	40173-00000	Black Foam Frame. Polycarbonate Clear Lens

## 3M™ 2700 Series

Designed for use over prescription glasses



Medium Impact

3M Order Code	Model #	Description
70071649514	2700-00000-100AS	Clear Frame/Clear Lens in Polybag

# 3M™ GoggleGear™ 500 Series

The 3M™ Goggle Gear, 500-Series is a low-profile design with an adjustable neoprene strap and indirect ventilation. These splash goggles with 3M™ Scotchgard™ Anti-Fog Coating help keep lenses clear in, steamy and wet environments. The Science Behind 3M™ Scotchgard™ Anti-Fog Technology 3M™ Scotchgard™ Anti-Fog Technology brings higher anti-fog performance to safety eyewear, helping workers see more clearly to complete on-the-job tasks. The anti-fogging properties are based on 3M internal testing per EN168 test method when compared to traditional anti-fog coatings. Here is how the anti-fogging properties work. When microscopic water droplets land on lenses without any type of coating, they bead up and form condensation and fog, obscuring your vision.

### Features and Benefits:

- 3M™ Scotchgard™ Anti-Fog Coating lasts longer\* than traditional anti-fog coatings, helping to increase eyewear performance in wet and steamy environments
- Workers may enjoy reliable, clearer sight longer, because the coating with its active ingredient is bonded to the lens. The coating retains its effectiveness for at least 25 washings with water, allowing workers to wear their eyewear longer
- The coating can be disinfected with diluted bleach soaking or alcohol wipes without losing its anti-fog performance. Washing with soap and water is considered a best practice and can enhance coating durability.
- The coating withstands disinfection with diluted bleach soaking or alcohol wipes without losing its anti-fog performance



3M Order Code	Model #	Description
70071676582	GG501NSGAF-AS	GG500 GoggleGear™ 500 Series with Scotchguard™ Anti-fog coating. Polycarbonate. Clear Lens.
70071675055	GG500-P1	GoggleGear Prescription Insert

**3M** Science.  
Applied to Life.™



# Body Protection

The range of 3M™ Protective Apparel offers a variety of features, from the use of fabrics with specialist treatments for enhanced wear and added protection, to breathable back panels for increased comfort. Our experts can work closely with you, to help you identify hazards and best protect your workers against them.

**#3MScienceOfSafety**



# Materials.

At 3M we have a select and high quality range of Coveralls, which provide protection against many hazards.

The 3M range of Protective Apparel offers a variety of features, from the use of fabrics with specialist treatments for enhanced wear and added protection, to breathable back panels for increased comfort. Our experts can work closely with you, to help you identify hazards and best protect your workers against them.

## Non-woven Polypropylene.

Offers comfortable light-duty protection against non-hazardous liquids and dust.

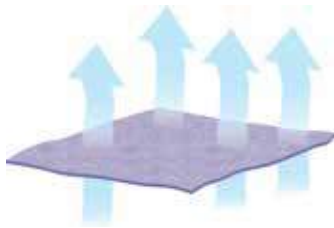

## Spunbond-meltblown polypropylene (SMS).

'SMS' can be layered differently to adjust the protective and physical properties of the material. Standard SMS-material is very breathable and offers a good barrier against dusts and limited liquid splashes. If treated, as 3M's Protective Coverall 4532+, an enhanced level of splash protection can be achieved.

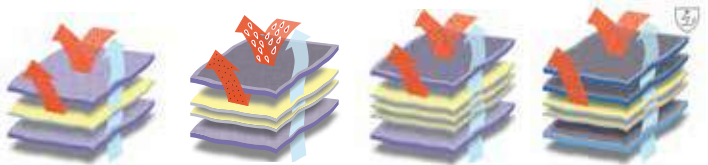

## Microporous laminates.

'Microporous laminates' offer a higher level of liquid splash protection, while the micropores allow for some breathability.



## Non-microporous laminates.

'Non-microporous laminates' can offer an even higher level of liquid protection. Adding multiple layers of the laminate can also increase robustness and chemical hold.



## Design features.

3M™ Protective Coveralls can offer a variety of features depending on your needs. The illustration below highlights some of the features available:

Contains no components made from natural rubber latex

Two-way zipper for on/off convenience

Anatomical design and fit for optimal wear, coverage and comfort

Elasticized waist and ankles and knit or elastic cuffs on all models for increased comfort and mobility



Three panel hood design on most models for compatibility with complementary PPE

Seamless shoulder and sleeve tops for fewer entry points for contaminants and increased comfort

Storm flap on all coveralls to help provide additional protection

Available in a variety of sizes (M-3XL).

- Backed by 3M global technical capabilities and support

## 3M™ Protective Coverall 4515

Low cost hazardous dust protection.

The 3M™ Protective Coverall 4515 is an economic solution to protect from hazardous dusts such as asbestos fibres exposed to during site inspection. While protecting on the outside, the breathable material allows air to escape from the inside to reduce heat build-up and discomfort. Available in white, blue and orange, the range is certified as CE Type 5/6 for both hazardous dusts and liquid splashes.

### Features and Benefits:

- Excellent barrier against dry particles and limited liquid splash (CE Type 5/6)
- Meets inward leakage requirements of EN 1073-2 for protection against nuclear particles
- Robust, highly breathable 50gsm SMS material
- 2-way zipper with storm flap for added on-off convenience and extra protection
- Elastic cuffs, waist and ankles for a better fit and freedom of movement
- Low-linting
- Available in white, blue and orange



#### Fabric material

The material used in the 3M protective coverall 4515 sandwiches a single thick filtering layer of melt-blown polypropylene between two thinner layers of softer spun bond polypropylene delivering a finished durable, breathable 50gsm protective material that aides air flow to reduce heat stress and improve comfort.

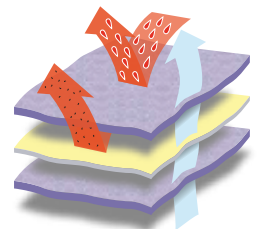

#### Seam Technology

Seams are serged for Type 5/6 protection.



3M AU Code	Model #	Description
GT700000224	4515	Coverall White type 5/6/ M
GT700000232	4515	Coverall White type 5/6/ L
GT700000240	4515	Coverall White type 5/6/ XL
GT700000257	4515	Coverall White type 5/6/ XXL
GT700000265	4515	Coverall White type 5/6 3XL
GT700000430	4515	Coverall Orange type 5/6 M
GT700000448	4515	Coverall Orange type 5/6 L
GT700000455	4515	Coverall Orange type 5/6 XL
GT700000463	4515	Coverall Orange type 5/6 XXL
GT700000471	4515	Coverall Orange type 5/6 3XL
GT700000299	4515	Coverall Blue type 5/6 M
GT700000307	4515	Coverall Blue type 5/6 L
GT700000315	4515	Coverall Blue type 5/6 XL
GT700000323	4515	Coverall blue type 5/6 XXL
GT700000331	4515	Coverall blue type 5/6 3XL
GT700000349	4515	Coverall blue type 5/6 4XL

# Body Protection

## 3M™ Protective Coverall 4510

The 3M™ Protective Coverall 4510 is an economic solution which offers quality and protection from limited chemical splashes such as those from paint spraying and is certified as CE Type 5/6 protection standard. The material is microporous, allowing air and moisture to escape from within the suit, while helping to protect from the hazard on the outside.

### Features and Benefits:

- Excellent barrier against dry particles and certain limited liquid chemical splash (CE Type 5/6)
- Laminated microporous material
- 2-way zipper with storm flap for added on-off convenience and extra protection
- Elastic cuffs, waist and ankles for a better fit and freedom of movement
- Super low-linting
- Anti-static treatment to EN 1149 to reduce charge build up (on inner surface)
- Meets inward leakage requirements of EN 1073-2 for protection against nuclear particles
- Biological protection tested to EN 14126

### Fabric material

The anti-static treated 3M protective coverall 4510 material is made using a layer of soft, spunbond polypropylene and a layer of light, but high quality anti-static treated polyethylene laminate film giving good levels of barrier efficiency and protection.

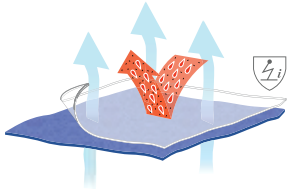

### Seam Technology

Seams are serged for Type 5/6 and certain seams bound for extra protection.

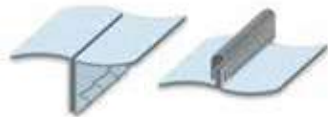

## 3M™ Protective Coverall 4520

Made using the latest lightweight, breathable material technology 3M presents the 3M™ Protective Coverall 4520, a Type 5/6 protective garment.

### Features and Benefits:

- Excellent barrier against dry particles and limited liquid splash (CE Type 5/6)
- SMMMS material technology for reduced heat stress and breathable comfort all day
- Low-linting
- Extremely lightweight and comfortable compared to many certified coveralls available in the marketplace
- 3-panel elasticated hood for enhanced compatibility with complimentary PPE
- Knitted cuffs and elasticated waist and ankles for increased comfort and freedom of movement
- 2-way zipper with sealable tab on stormflap for added convenience and extra protection
- Anti-static treatment to EN 1149 to reduce charge build up
- Meets inward leakage requirements of EN 1073-2 for protection against nuclear particles

### Fabric material

With 3 layers of melt-blown polypropylene in-between 2 layers of spunbond polypropylene, the 3M protective coverall 4520 fabric has been specifically designed to improve air flow and breathability, thereby reducing heat stress and enhancing comfort levels. The middle 3 layers act as a filter to effectively protect against hazardous dust and splash and the outer 2 layers offer strength and durability whilst maintaining a soft, comfortable feel.

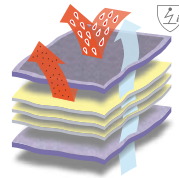

### Seam Technology

Seams are serged for Type 5/6 protection.



3M AU Code	Model #	Description
GT700000851	4510	Coverall White type 5/6 M
GT700000869	4510	Coverall White type 5/6 L
GT700000877	4510	Coverall White type 5/6 XL
GT700000885	4510	Coverall White type 5/6 XXL
GT700000893	4510	Coverall White type 5/6 3XL

3M AU Code	Model #	Description
GT700000596	4520	Coverall White+Green type 5/6 XL
GT700000604	4520	Coverall White+Green type 5/6 2XL
GT700000612	4520	Coverall White+Green type 5/6 3XL

# Body Protection

## 3M™ Protective Coverall 4535

If you're looking for a balance of protection, durability and additional comfort, look no further than the 3M™ Protective Coverall 4535. Certified as CE Type 5/6 protection, it utilises a dual material design with added comfort features to optimise wearer acceptance.

### Features and Benefits:

- Excellent barrier against dry particles and certain limited liquid chemical splash (CE Type 5/6)
- Robust, super low-linting laminated microporous material
- Extra large breathable back panel for improved air circulation and reduced heat stress
- 2-way zipper with storm flap for added on-off convenience and extra protection
- Knitted cuffs with elasticated waist and ankles for increased comfort and freedom of movement
- Low-linting
- Anti-static treatment to EN 1149 to reduce charge build up (on inner surface, white material only)
- Meets inward leakage requirements of EN 1073-2 for protection against nuclear particles

### Fabric material

The front of the 3M protective coverall 4535 combines a high quality polyethylene laminate providing an excellent barrier, on top of a layer of soft, spunbond polypropylene fibres creating a robust, yet comfortable 55gsm protective fabric. The large blue back panel is made from 5 layers of spunbond and meltblown polypropylene giving excellent breathability, whilst maintaining the Type 5/6 level of protection.

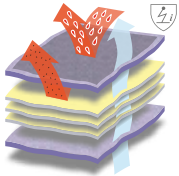

SMMMS back-panel.

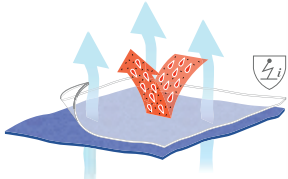

Microporous laminate fabric.

### Seam Technology

Seams are serged for Type 5/6 and certain seams bound for extra protection.



## 3M™ Protective Coverall 4540+

With premium dual material technology and offering CE Type 5/6 protection, the 3M™ Protective Coverall 4540+ is ideal for applications where both high levels of protective performance and comfort are desired.

### Features and Benefits:

- Excellent barrier against dry particles and certain liquid chemical splash (CE Type 5/6)
- Soft and light, super low-linting laminated microporous material that drapes and hangs well over the body facilitating ease of movement
- Back panel made of breathable SMMMS material for improved air circulation and reduced heat stress
- 2-way zipper with fully sealable storm flap for added on-off convenience and extra protection
- 3-panel hood design for enhanced compatibility with complimentary PPE
- Knitted cuffs and elasticated waist and ankles for increased comfort and freedom of movement
- Enhanced and reinforced triangular gusset panel to increase product durability
- Anti-static treatment to EN 1149 to reduce charge build up (on inner surface, white material only)
- Meets inward leakage requirements of EN1073-2 for protection against nuclear particles
- Low linting

### Fabric material

The 3M protective coverall 4540+ material is made using a composite layer of soft, spunbond fibres and a layer of light, but high quality polyethylene laminate film giving excellent levels of barrier efficiency and protection. Compared with many other laminates it has a particularly soft feel and drapes well over the body. The blue back panel is made from 5 layers of spunbond and meltblown polypropylene giving excellent breathability, whilst maintaining the Type 5/6 level of protection.

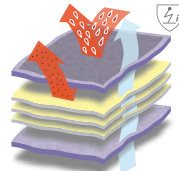

SMMMS back-panel.

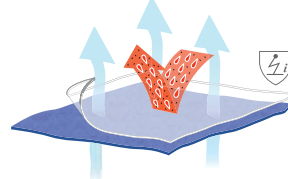

Microporous laminate fabric.

### Seam Technology

Seams are serged for Type 5/6 and certain seams bound for extra protection.



3M AU Code	Model #	Description
XA100006791	4535	Coverall White/Blue type 5/6 Size M
GT700001073	4535	Coverall White/Blue type 5/6 Size L
XA100006817	4535	Coverall White/Blue type 5/6 Size XL
GT700001099	4535	Coverall White/Blue type 5/6 Size XXL

3M AU Code	Model #	Description
UU001501566	4540+	Coverall White & Blue type 5/6 M
UU001501574	4540+	Coverall White & Blue type 5/6 L
UU001501582	4540+	Coverall White & Blue type 5/6 XL
UU001501590	4540+	Coverall White & Blue type 5/6 XXL
UU001501608	4540+	Coverall White & Blue type 5/6 3XL

# Body Protection

## 3M™ Protective Coverall 4565

Offering CE Type 4/5/6 protection, the 3M™ Protective Coverall 4565 has an impressive level of liquid barrier protection whilst maintaining its unique soft feel and well fitting drape. With tape applied over the seams a greater level of total protection and seam durability is offered versus Type 5/6 products.

### Features and Benefits:

- Excellent barrier against dry particles, liquid certain chemical splash and spray (CE Type 4/5/6)
- Taped seams across the suit for better protection and increased durability
- Soft, well-draping laminated material
- Biological protection tested to EN 14126
- 2-way zipper with fully sealable storm flap for added on-off convenience and extra protection
- 3-panel hood design for enhanced compatibility with complimentary PPE
- Knitted cuffs and elasticated waist and ankles for increased comfort and freedom of movement
- Anti-static treatment to EN 1149 to reduce charge build up
- Super low-linting
- Supplied in space saving vacuum packaging
- Meets inward leakage requirements of EN 1073-2 for protection against nuclear particles

### Fabric material

20% lighter than previous 3M polyethylene laminate materials, the 3M protective coverall 4565 combines a composite base of non woven fibres and a polyethylene film giving good barrier efficiency against many hazardous liquids. The laminate is also ultra-low linting and anti-static treated making it suitable for a wide variety of potentially hazardous applications.



### Seam Technology

Seams are stitched and overtaped with a red protective tape to offer increased seam strength and an effective barrier to liquids and particulates.

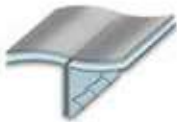

## 3M™ Protective Coverall 4570

The 3M™ Protective Coverall 4570 is a high performance chemical protective suit, certified to Type 3/4/5/6 levels of protection, making it suitable to protect against a range of chemical jets and sprays. With additional design features including an enlarged zip and finger loops, a double-closing storm flap system and chin flap, convenience of use can be offered without compromising the high level of protection given.

### Features and Benefits:

- Excellent barrier for jet spray and liquid tight chemical protection (CE Type 3/4)
- Biological / infective agent protection (EN 14126) to the maximum class
- Seams are taped with a multi layer coextruded clear tape, giving a discreet finish and a consistent seal and barrier
- 3-panel hood design for enhanced compatibility with complimentary PPE
- Two stormflaps combined with double colourcoded zips to create a double seal for added convenience and extra protection
- Large zip for ease of use
- Elasticated cuffs with thumb loops for secure fit during overhead work
- Elasticated waist and ankles for increased comfort and freedom of movement
- Glued in waist elastic and seam free shoulders to minimise entry points etc
- Adhesive chin flap
- Super low-linting
- Anti-static treatment to EN 1149 to reduce charge build up (on inner surface)
- Meets inward leakage requirements of EN 1073-2 for protection against nuclear particles

### Fabric material

The 3M™ Protective Coverall 4570 uses a heavy-duty material blending a soft inner layer of spun bond fibres with multiple outer layers of a high performance anti-static treated polyethylene laminate, to offer a high level of liquid protection.

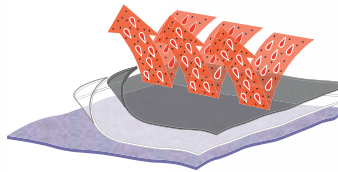

### Seam Technology

Seams are stitched and overtaped with a clear heat applied multi-layer chemically protective tape to offer increased strength and an effective barrier to liquids and particulates.

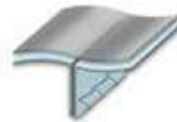

3M AU Code	Model #	Description
GT700001149	4565	Coverall White & Red type 4/5/6 L
GT700001156	4565	Coverall White & Red type 4/5/6 XL
GT700001164	4565	Coverall White & Red type 4/5/6 2XL
GT700001172	4565	Coverall White & Red type 4/5/6 3XL
GT700001180	4565	Coverall White & Red type 4/5/6 4XL

3M AU Code	Model #	Description
GT700001222	4570	Coverall Grey type 3/4/5/6 XL
GT700001230	4570	Coverall Grey type 3/4/5/6 XXL
GT700001248	4570	Coverall Grey type 3/4/5/6 3XL
GT700004911	4570	Coverall Grey type 3/4/5/6 4XL

# Product selector diagram.\*

\*Warning: This product selector is intended to provide guidance on key features of the 3M product range. The products shown highlight some of the products which may be considered but product suitability will depend on the particular situation and product selection should always be made after a risk assessment by a competent person knowledgeable of the actual working conditions and limitations of the PPE.

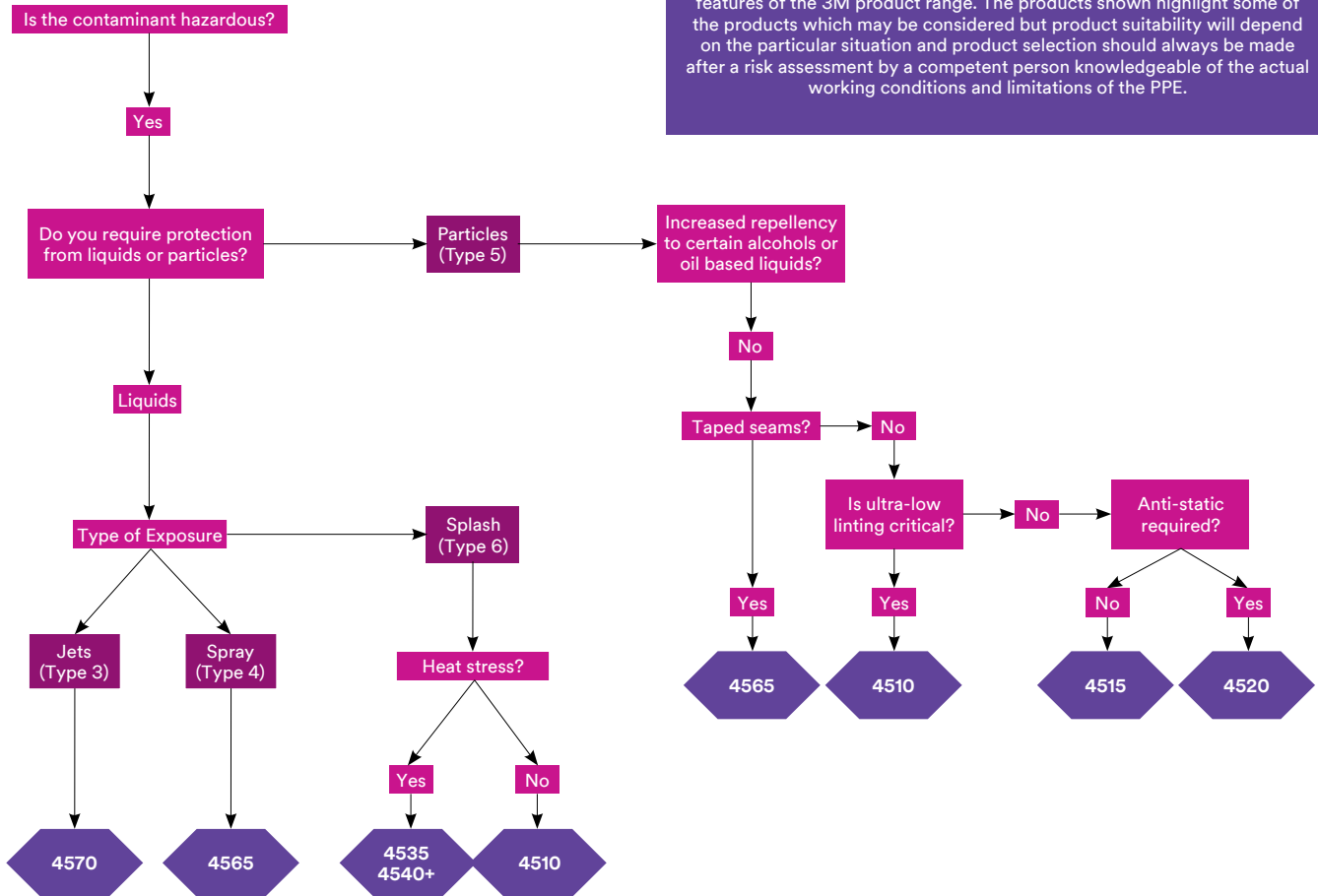

## 3M™ Protective Coveralls Protection Types

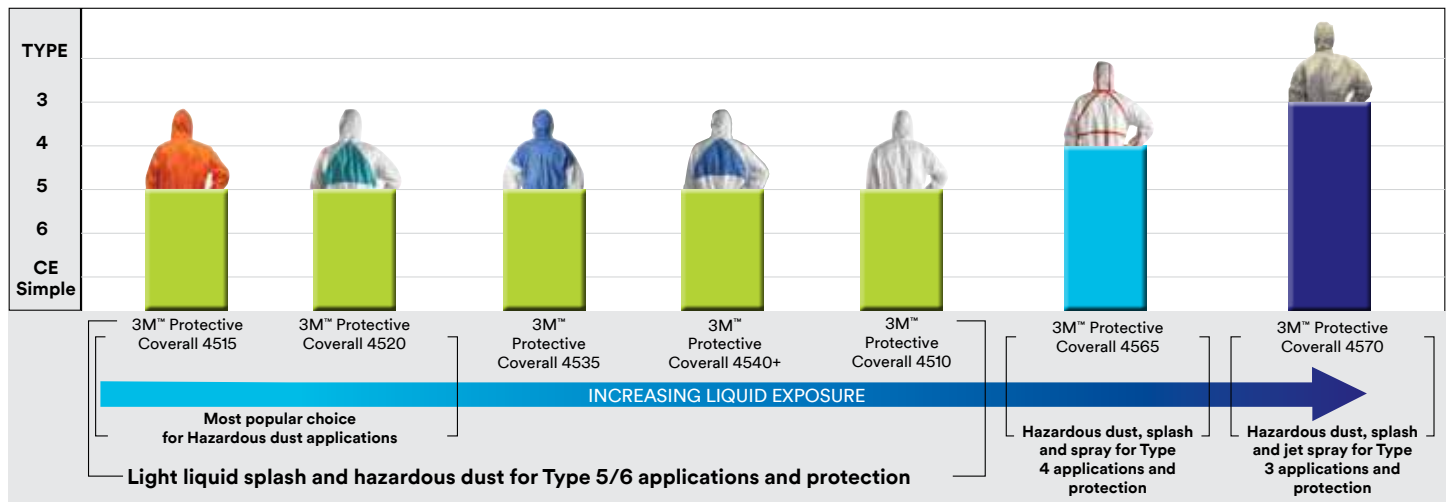

This guide is only an outline. It should not be used as the only means for selecting protective clothing. Always read and follow all user instructions supplied with your 3M™ Protective Coveralls in order to ensure correct operation. Final determination as to the suitability of these products for a particular situation is the employers responsibility. If in doubt contact a safety professional. For further information on the performance data of these garments or for any other questions contact your local 3M representative. LIMITATION OF LIABILITY: Except as provided above, 3M shall not be liable or responsible for any loss or damage, whether direct, indirect, incidental, special or consequential arising out of the sale, use or misuse of 3M PSD products, or the user's inability to use such products.

# Product selector table.\*



	3M	4510	4515	4520	4535	4540+	4565	4570
CE Certification**								
Material Weight		47gsm	50gsm	43gsm	55gsm	49gsm	49gsm	92gsm
Size		M-3XL	M-3XL	M-3XL	M-3XL	M-3XL	M-3XL	M-3XL
Colours								
Light-duty cleaning, warehousing, janitorial			●					
Asbestos Inspection, site preparation, insulation		●	●	●	●	●	●	
Asbestos removal		●	●	●	●	●	●	
Cement manufacturing, metal grinding & polishing		●	●	●	●	●	●	
Light industrial cleaning, machine maintenance		●	●	●	●	●	●	
Pharmaceutical processing, handling toxic powders		●		●	●	●	●	
Painting & coating, resins		●			●	●	●	
Cleanrooms		●					●	
Pesticide spraying							●	●
Chemical mixing and handling							●	●
Chemical spills, emergency response, decontamination, tank cleaning								●

● Popular choice ● Suitable for consideration

\* In all cases, product selection should be based on a full risk assessment. Always read product user information. Use limitations and performance data should be considered to ascertain the protection required. If in doubt, contact a safety professional. This guide is only an outline. It should not be used as the only means for selecting protective clothing. Details regarding performance and limitations are set out on the packaging and user instructions. Before using any protective clothing, the wearer must read and understand the user instructions for each product. Specific country legislation must be observed. If in doubt, contact a safety professional or 3M – 3M.com.nz/ppesafety. Always check the compatibility of the suit material before selection. Please note that the personal protective equipment (PPE) shown highlight some of the products which may be considered. Sections of the most appropriate PPE will depend on the particular situation and should be made only by a competent person knowledgeable of the actual working conditions and the limitations of PPE.

\*\* See user instructions or technical datasheets for full details.



Fall Protection



# Core Range Fall Protection

Height Safety | Confined Space | Industrial Rescue

#3MScienceOfSafety



# We help you unravel the standards and regulations.

## Fall Arrest Devices

From rooftops, communication towers, mining and more, we offer a full suite of information and versatile fall protection solutions to help protect your workforce. With an extensive range of products, third party certified to Australian and global standards, including the updated AS/NZS 1891.1:2020, AS 1891.3:2020 amd1:2021 and AS 1891.5:2020 standards.



## Leading Edge Applications

As common as they are hazardous, leading edges—the unprotected side and edge of a floor, roof or form work for a floor—require specialized fall protection designed for the task. That's why we've developed a universal orange icon that we placed all of our leading edge 3M Fall Protection products, such as our self-retracting Lifelines, DBI-SALA Nano-Lok LE and Smart Lock LE and PROTECTA Rebel LE plus DBI-SALA Force2 Cut Resistant lanyards.



# Safety as basic as the ABCs!

A typical Personal Fall Arrest System (PFAS) incorporates three components, often described as the ABC's of fall protection. The anchorage/anchorage connector, body support and connecting device—when used together—form a complete system for maximum worker protection. But don't forget the other important components of a comprehensive fall protection program: descent and rescue, education and fall protection for tools.

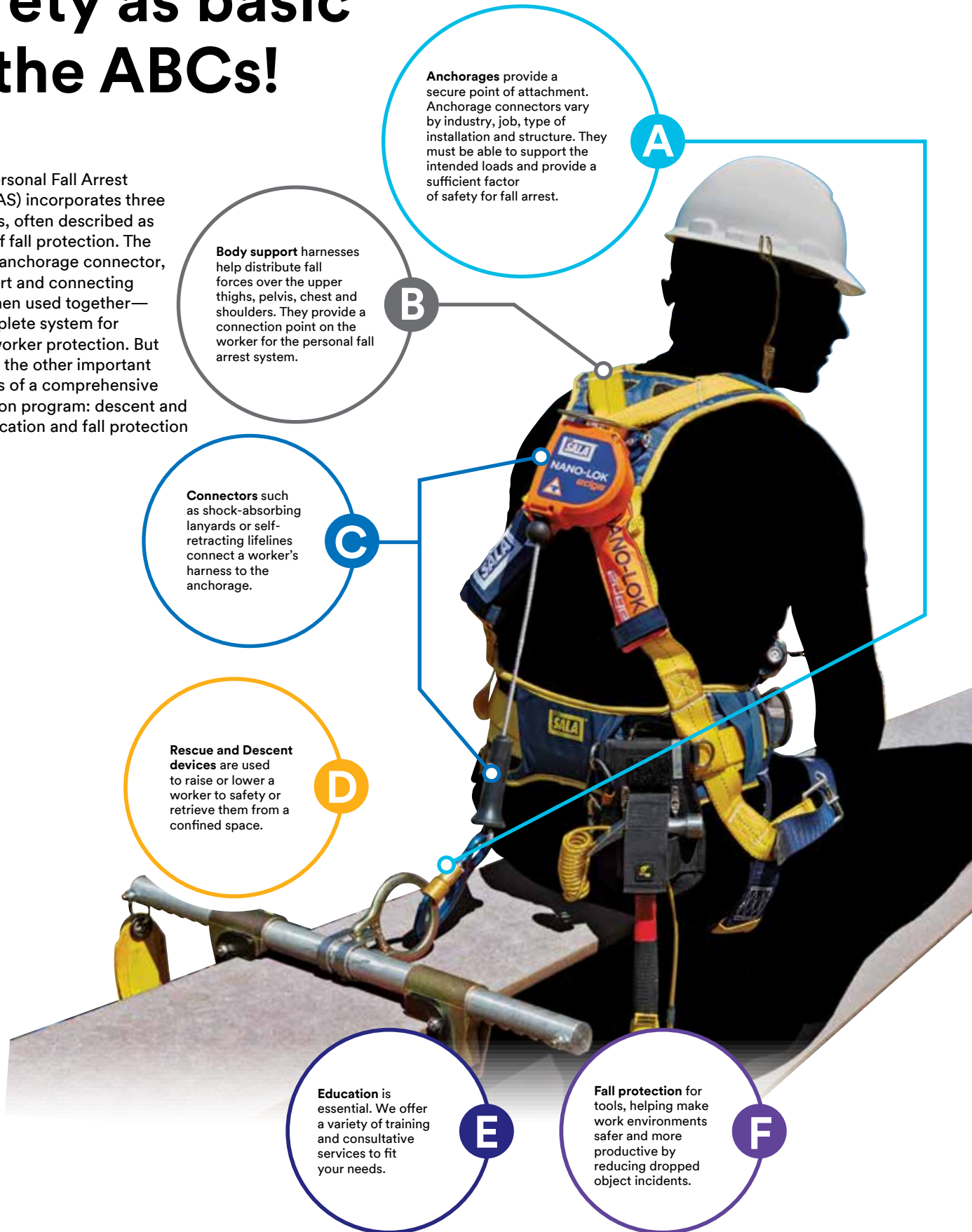

**A** **Anchorage** provide a secure point of attachment. Anchorage connectors vary by industry, job, type of installation and structure. They must be able to support the intended loads and provide a sufficient factor of safety for fall arrest.

**B** **Body support** harnesses help distribute fall forces over the upper thighs, pelvis, chest and shoulders. They provide a connection point on the worker for the personal fall arrest system.

**C** **Connectors** such as shock-absorbing lanyards or self-retracting lifelines connect a worker's harness to the anchorage.

**D** **Rescue and Descent devices** are used to raise or lower a worker to safety or retrieve them from a confined space.

**E** **Education** is essential. We offer a variety of training and consultative services to fit your needs.

**F** **Fall protection for tools**, helping make work environments safer and more productive by reducing dropped object incidents.



## The sky's the limit.

**“Dedicated To Bringing Every Worker At Height Home Safely.”**

3M Fall Protection, a part of 3M's Personal Safety Division is dedicated to fall protection and rescue. Our focus is razor sharp, it continually drives us to design and manufacture the safest possible height safety gear. We understand the industries we serve and listen to the workers in the field. We employ the best engineers to create innovative solutions and patent the products that keep workers safe at heights around the world. 3M Fall Protection has the best quality and largest range of fall protection products in the industry. But we're more than a product company. We take an innovative approach in bringing our products to the field.

We have created international partnerships and a vast network of authorised distributors, certified installers and service centres. We offer on-site and in-house training. Our manufacturing sites hold ISO 9001 quality accreditation, as well as ISO 14001 environment and AS4801 Health & Safety accreditation. 3M Fall Protection is one of the world's leading manufacturers of fall protection and rescue equipment, with decades of experience and a legacy of innovation. Look for complete solutions in our extensive range of DBI-SALA® and PROTECTA® brands.

## Fall Protection Demo Trailer

**Experience safety, comfort and performance. Backed by Science.**

Our demo trailers are back in action post Covid, learn more about our 3M complimentary demonstrations





# Anchorage

3M offers the most complete selection of temporary and permanent anchorage connectors available. Our safety anchors include steel anchors, concrete anchors, roof anchors and specialty anchors like our vacuum mount for smooth surface environments. We manufacture anchor systems to fit your unique applications.

# DBI-SALA Anchorages

## 3M™ DBI-SALA® Structural Mount Anchors



3M Order Code	Model #	Description	MBS
70007440707	2101630	D-ring with anchorage plate	22.2kN
70007900361	7234034	Single point anchor	22kN

## 3M™ DBI-SALA® Roof Mount Anchors



3M Order Code	Model #	Description	MBS	Certified
AT010621947	2101734	Anchor side truss mount	15kN	✓
AT010621954	2101735	Anchor top purlin mount	15kN	✓

## 3M™ DBI-SALA® Tie-Off Anchor Strap Adaptor with Interlocking Rings



3M Order Code	Model #	Description	Width	MBS	Certified
70007928834	E849-005	0.5 m	75mm	22.2kN	✓
70007929196	E849-008	0.8 m	75mm	22.2kN	✓
70007925731	E849-010	1 m	75mm	22.2kN	✓
70007928909	E849-012	1.2 m	75mm	22.2kN	✓
70007925566	E849-015	1.5 m	75mm	22.2kN	✓
70007925574	E849-020	2 m	75mm	22.2kN	✓

## 3M™ DBI-SALA® Round Anchor Strap



3M Order Code	Model #	Width	Length	MBS	Certified
AT010622010	1003581	25mm	0.6m	22.2kN	✓
AT010622028	1003582	25mm	1.0m	22.2kN	✓
AT010622036	1003583	25mm	1.2m	22.2kN	✓
AT010622044	1003584	25mm	1.5m	22.2kN	✓
AT010622051	1003585	25mm	2.0m	22.2kN	✓
AT010622077	1003587	25mm	3.0m	22.2kN	✓

## 3M™ DBI-SALA® Concrete Mount Anchors



3M Order Code	Model #	Description	MBS
70007440699	2101004	Concrete detent anchor	22.2kN
70007441093	2104560	Bolt on, with swivel D-ring	22.2kN
70007451167	2101000	Concrete Socket and Cap to suit Concrete Detent Anchor	N/A

## 3M™ DBI-SALA® Beam Anchors



3M Order Code	Model #	Description	MBS	Certified
70007440806	2103143	Beam trolley, installs onto 76mm - 203mm wide I-beam flange up to 17mm thick	22kN	
70007442091	2108406	Fixed beam anchor, installs onto 63mm - 305mm wide I-beam flange up to 38mm	22.2kN	
70804490921	2104711	Sliding Beam Anchor, Small, Adjustable 89mm - 355mm	15kN	✓
70804490939	2104716	Sliding Beam Anchor, Large, Adjustable 305mm - 762mm	15kN	✓

## 3M DBI-SALA Round Anchor Strap with protective wear sleeve

Protective wear sleeve protects load bearing web from sharp edges, dirt and wear for a long functional life.



3M Order Code	Model #	Width	Length	MBS	Certified
AT010622085	1003588	25mm	0.6m	40kN	✓
AT010622101	1003590	25mm	1.2m	40kN	✓
AT010622119	1003591	25mm	1.5m	40kN	✓

MBS = Minimum Breaking Strength  
Models marked 'Certified' are to AS/NZS 5532:2013 standard

## 3M™ DBI-SALA® Specialty Anchors

### 3M™ DBI-SALA® First-Man-Up™ Systems



3M Order Code	Model #	Description
70007441051	2104530	1.8 - 3.6 m working length
70007441069	2104531	2.4 - 4.8 m working length

### 3M™ DBI-SALA® Door Jamb Anchor



3M Order Code	Model #	Description	MBS
70007439592	2100080	Door/Window Jamb Anchor	22kN

### 3M™ DBI-SALA® Vacuum Anchor System



3M Order Code	Model #	Description
70007452900	2200108	Mobi Lok self contained aviation compliant vacuum anchor.
70007453015	2200400	12 m Sayflite vacuum anchor

## 3M™ DBI-SALA® Horizontal Lifeline Systems

### 3M™ DBI-SALA® Sayflite™ Temporary Lifeline Rope Systems

Up to 2 users



3M Order Code	Model #	Length
70007490355	7600505	15 m
70007490371	7600507	20 m
70007490389	7600508	25 m
70007490405	7600510	30 m

### 3M™ DBI-SALA® EZ-Line™ Retractable Horizontal Lifeline Wire Cable System

Up to 6 users (2 per span)

Note: DBI-SALA® Engineered permanent horizontal lifeline systems and Sayflite™ post and base system also available.



3M Order Code	Model #	Length
70007488128	7605061	18 m

### 3M™ DBI-SALA® SecuraSpan™ Temporary Horizontal Lifeline Wire Cable Systems

Up to 6 users (2 per span)



3M Order Code	Model #	Length
70007959672	7400120	6 m
70008287875	7400130	9 m
70007936290	7400140	12 m
70008287883	7400150	15 m
70007962155	7400160	18 m

Posts not included

# Protecta Anchorages

## 3M™ Protecta® Anchorage Devices

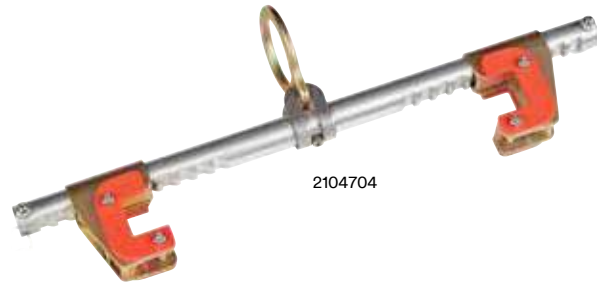

3M Order Code	Model #	Description	MBS	Minimum Width	Maximum Width	Certified
70007649455	2199938	Sliding Rail Anchor	16kN	2.75 inch	3.25 inch	
70804486242	2104704	Protecta® Sliding Beam Anchor	15kN	89mm	356mm	✓

## 3M™ Protecta® Dual Ring Cable Tie-Off Adaptor



3M Order Code	Model #	Size	Width	MBS
70007442240	2190100	0.9 m	6.35mm	22.2kN
70007442257	2190101	1.2 m	6.35mm	22.2kN
70007442265	2190102	1.8 m	6.35mm	22.2kN

## 3M™ Protecta® Temporary Horizontal Lifeline

Up to 2 users



3M Order Code	Model #	Description
70007427167	1200101	Web HLL E6 18m Pro with Anchor Strap

## 3M™ Protecta® Tie-Off Adaptor



3M Order Code	Model #	Size	Width	MBS
70007935250	AM500/100AU	1.0 m	45mm	22.2kN
70007938429	AM500/150AU	1.5 m	45mm	22.2kN

## 3M™ Protecta® P50 Round Anchor strap

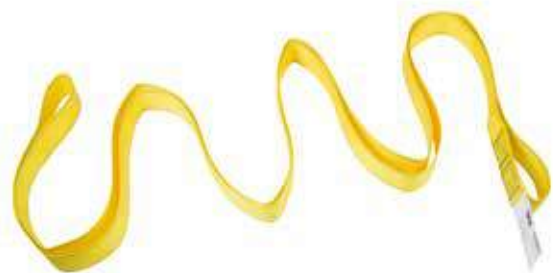

3M Order Code	Model #	Size	Width	MBS
AT010621657	5900583A	2.0 m	25mm	15kN

MBS = Minimum Breaking Strength  
Models marked 'Certified' are to AS/NZS 5532:2013 standard



# Body Harnesses

Safety harnesses provide comfort and confidence, and directly affects the user's productivity, as well as giving them flexibility to do what needs to be done on the job site. 3M has the latest in full body harness protection. DBI-SALA® and PROTECTA® harnesses - ExoFit STRATA™, ExoFit NEX™, Delta™, P200, P100 and P50 - have earned a reputation as top full body harnesses for maximum comfort, freedom of movement and ease-of-use.





## 3M™ DBI-SALA® ExoFit STRATA™

1

Designed for all day use with in-built weight distribution technology

- Patented design redistributes weight off wearer's shoulders
- Lightweight aluminium D-rings
- Easy-linking SRL adapter & standup D-ring simplify connections
- Mesh padding enhances breathability and comfort
- Revolving adjusters maintain fit and lock excess webbing in place
- Quick-connecting buckles enhance productivity

Select your work:

Construction	1	2	3	4
Tower Climbing		2	3	4
Riggers		2	3	4
Crossover		2	3	4
Wind Energy		2		



## 3M™ DBI-SALA® ExoFit NEX™

2

Premium all day comfort harness

- Revolving adjusters maintain fit and lock excess webbing in place
- Lightweight aluminium D-rings
- Quick-connecting buckles enhance productivity
- Non-slip, moisture-wicking padding
- Water repellent coating resists mould and dirt
- Standup dorsal D-ring simplifies connections

**ExoFit NEX™ Plus** also available, featuring a built-in SRL adapter.

Mining		2	3	4
Oil & Gas		2		4
Rope Access/Rescue		2		
Positioning		2	3	4
Scaffolding	1	2	3	4

# Body Harnesses



## 3M™ DBI-SALA® Delta™ Comfort

3

Light weight comfort harness

- Revolving adjusters maintain fit and lock excess webbing in place
- Vented shoulder, back and leg padding helps keep wearer cool
- Sewn-in dorsal pad holds personal SRLs and helps eliminate slippage
- Visual indicators alert wearer if harness has been impact-loaded



## 3M™ DBI-SALA® Delta™

4

The every day workers harness

- Revolving adjusters maintain fit and lock excess webbing in place
- Tangle-free design falls into place when donned
- Ergonomic hip pad supports back and hips
- Quick-connect buckles enhance productivity
- Water repellent coating resists mold and dirt
- Standup dorsal D-ring simplifies connections

Select your size:

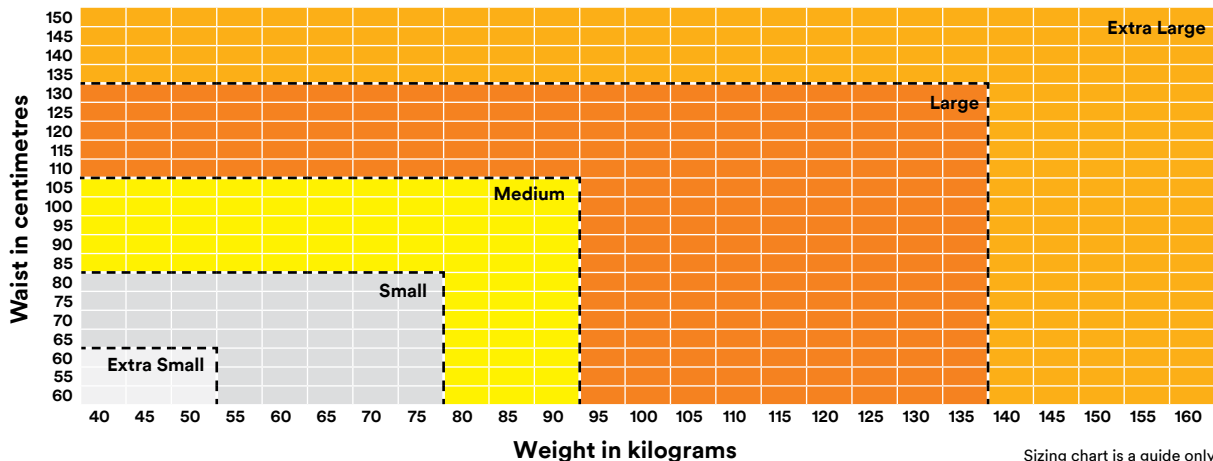

Sizing chart is a guide only

# 3M™ DBI-SALA® ExoFit NEX™ Full-Body Harnesses

The ultimate full-body comfort harnesses.

ExoFit NEX™ harnesses are the most advanced harnesses in the industry. They're the culmination of our experience with ExoFit™ and ExoFit™ XP, ongoing research and the incorporation of new materials and innovative features.

### Features and Benefits:

#### Stand-Up Dorsal D-ring

- Patented spring-loaded design automatically stands-up, ensuring fast, easy and safe connections to your fall arrest system.

#### Covered Labels and RFID equipped

- A press stud cover protects harness labels.

#### Impact Indicator

- Rip-stitch indicators allow you to inspect the harness at a glance, for prior damaging impact loads.

#### Vertical torso adjuster

- Simple and fast adjustments that eliminate loose ends and lock into place, preventing slippage.

#### Lightweight Aluminum D-rings

- Extremely lightweight alloy commonly used in military and aerospace offers a higher level of security and comfort.

#### Integrated Suspension Relief Straps

- Provide an adjustable, continuous loop for post fall, offering suspension relief.

#### Reflective Material

- For greater visibility in dark and dangerous environments, reflective material is integrated on legs, chest, shoulders and back.

#### Ultra-Soft Edging

- Moves with you - doesn't rub or chafe.

#### Hybrid Comfort Padding

- Lightweight, moisture wicking, and breathable padding won't move or slip, keeping the wearer comfortable at all times.

#### Lanyard Keepers

- Easy holstered snap hooks breakaway to avoid trip hazard.

#### Built-In Carrying Pocket

- Conveniently holds and protects a mobile phone, camera, or other items.

#### Rigid Hip Padding Loops

- Prevents equipment pouches from sagging and reduces abrasion in vulnerable areas

#### Web-Locking Quick-Connect Buckles

- Lightweight one-handed use with memory-fit web-lock ensures fast, non-slipping connections.



**BONUS**  
Harness storage  
back pack with every  
ExoFit NEX™ harness



# Body Harnesses

## 3M™ DBI-SALA® ExoFit NEX™ Riggers Harness

Ideal for use as a professional general purpose harness in rigging, ladder climbing and confined space access work.

Front and rear lightweight aluminum D-rings, Web-Locking Quick-Connect Buckles, Vertical torso adjuster, nonslip hybrid comfort padding, suspension trauma straps, confined space attachment points, impact indicator.



3M Order Code	Model #	Size
70007925673	603S2018	Small
70007925467	603M2018	Medium
70007926127	603L2018	Large
70007926218	603XL2018	Extra Large

## 3M™ DBI-SALA® ExoFit NEX™ Riggers Harness with Stainless Steel Hardware

Ideal for use as a professional general purpose harness in rigging, ladder climbing and confined space access work.

Front and rear lightweight Stainless Steel D-Rings, Stainless Steel Quick-Connect Buckles, Vertical torso adjuster, nonslip hybrid comfort padding, suspension trauma straps, confined space attachment points, impact indicator.



3M Order Code	Model #	Size
70007927331	603S1020	Small
70007927349	603M1020	Medium
70007928552	603L1020	Large
70007928560	603XL1020	Extra Large

## 3M™ DBI-SALA® ExoFit NEX™ Cross-Over Harness

Ideal for the professional performing roof construction, maintenance and ladder access work.

Front and rear lightweight aluminum D-rings, Web-Locking Quick-Connect Buckles, Vertical torso adjuster, nonslip hybrid comfort padding, suspension trauma straps, impact indicator.



3M Order Code	Model #	Size
70007946505	613S2016	Small
70007926655	613M2016	Medium
70007941803	613L2016	Large
70007936696	613XL2016	Extra Large

## 3M™ DBI-SALA® ExoFit NEX™ All Purpose Harness

Ideal for the professional performing confined space access work, ladder access and rescue.

Front and rear lightweight aluminum D-rings, Web-Locking Quick-Connect Buckles, Vertical torso adjuster, nonslip hybrid comfort padding, suspension trauma straps, confined space attachment points, impact indicator.



3M Order Code	Model #	Size
70007929378	623S2018	Small
70007926010	623M2018	Medium
70007925798	623L2018	Large
70007925764	623XL2018	Extra Large

## 3M™ DBI-SALA® ExoFit NEX™ Tower Workers Harness

Ideal for the professional performing pole work, rigging and work positioning.

Front and rear lightweight aluminum D-rings, Web-Locking Quick-Connect Buckles, Vertical torso adjuster, nonslip hybrid comfort padding, suspension trauma straps, impact indicator, includes suspension seat.



3M Order Code	Model #	Size
70007935102	653S4016	Small
70007926366	653M4016	Medium
70007928917	653L4016	Large
70007943510	653XL4016	Extra Large

## 3M™ DBI-SALA® ExoFit NEX™ Wind Energy Harness

Ideal for the professional wind tower worker, uniquely designed with specialised features for wind energy needs.

Front and rear lightweight aluminum D-rings, Web-Locking Quick-Connect Buckles, Vertical torso adjuster, nonslip hybrid comfort padding, suspension trauma straps, impact indicator, includes wear pad on waist belt.



3M Order Code	Model #	Size
70007930723	603S4044	Small
70007930699	603M4044	Medium
70007943759	603L4044	Large
70007960613	603XL4044	Extra Large

Also available: models with additional features suitable for specific industry applications

# Body Harnesses

## 3M™ DBI-SALA® ExoFit NEX™ Climbing Harness

Ideal for the professional performing rescue and emergency services, industrial rope access, abseiling and tower work.

Front and rear lightweight aluminum D-rings, Web-Locking Quick-Connect Buckles, Vertical torso adjuster, nonslip hybrid comfort padding, suspension trauma straps, impact indicator.



3M Order Code	Model #	Size
70007939559	683S4016	Small
70007931937	683M4016	Medium
70007938502	683L4016	Large
70007947370	683XL4016	Extra Large

## 3M™ DBI-SALA® ExoFit NEX™ Suspension Harness

Ideal for the professional performing rescue and emergency services, industrial rope access, abseiling and tower work.

Front and rear lightweight aluminum D-rings, Web-Locking Quick-Connect Buckles, Vertical torso adjuster, nonslip hybrid comfort padding, suspension trauma straps, impact indicator.



3M Order Code	Model #	Size
70007934402	783S4016	Small
70007931028	783M4016	Medium
70007927661	783L4016	Large
70007934469	783XL4016	Extra Large

## 3M™ DBI-SALA® ExoFit NEX™ Flotation Harness

Ideal for the professional requiring both fall and buoyancy protection in open or closed waters.

275N integral personal flotation device, rear stainless steel D-ring, front fall arrest loops, stainless steel quick-connect buckles, non-slip hybrid comfort padding, suspension trauma straps, impact indicator (also available with 300N MED/SOLAS personal flotation device).



3M Order Code	Model #	Size
70008280318	603S1034	Small 275N
70007936233	603M1034	Medium 275N
70007941191	603L1034	Large 275N
70007945168	603XL1034	Extra Large 275N
70008286240	603S1036	Small 300N
70007943023	603M1036	Medium 300N
70007946786	603L1036	Large 300N
70007956421	603XL1036	Extra Large 300N

## 3M™ DBI-SALA® ExoFit STRATA™ Construction Harness

Ideal for the professional performing construction, rigging, ladder climbing and general height safety work where the use of a Personal SRL is used on a regular basis.

Front and rear lightweight aluminum D-rings, Personal SRL Adapter, Weight Distribution System, Vertical torso adjuster, Web-Locking Quick-Connect Buckle, Breathable mesh back pad, wide padded lower back/hip pad, waist belt, suspension trauma straps, confined space loops, impact indicator.



3M Order Code	Model #	Size
70007949574	903S2018	Small
70007947321	903M2018	Medium
70007951422	903L2018	Large
70008291406	903XL2018	Extra Large

## 3M™ DBI-SALA® ExoFit STRATA™ Utility Harness

Ideal for the professional performing work positioning, construction, rigging, ladder climbing and general height safety work where the use of a Personal SRL is used on a regular basis.

Front and rear lightweight aluminum D-rings, Personal SRL Adapter, Weight Distribution System, Vertical torso adjuster, Web-Locking Quick-Connect Buckle, Breathable mesh back pad, wide padded lower back/hip pad, waist belt, suspension trauma straps, confined space loops, impact indicator.



3M Order Code	Model #	Size
70007947339	923S2018	Small
70007945663	923M2018	Medium
70007949616	923L2018	Large
70007953097	923XL2018	Extra Large

# 3M™ DBI-SALA® Delta™ Full-Body Harnesses

The safety harness that won't weigh you down.

Delta™ harnesses combine a set of “industry-first” advancements, with popular features making them the workhorse of the industry. Today's Delta™ represents the culmination of more than twenty years of design, research, manufacturing know-how and on-the-job performance.

### Features and Benefits:

#### Quick-Connect Buckles

- Offers one-handed operation and smooth adjustment.

#### Easy Grip End Tabs and Keepers

- For fast, efficient and secure web adjustment.

#### Stand-Up Dorsal D-Ring

- Patented spring-loaded design automatically stands up ensuring fast, easy and safe connections to your fall arrest system.

#### Impact Indicator

- Rip-stitch indicator allows the user to quickly and easily inspect the harness for impact loading.

#### Label Pack

- Laminated PVC labels resistant to abrasion, UV, ambient heat, water and a wide range of chemicals. Features permanent indented print of critical product information ensuring it remains visible for the life of the harness.

#### RFID equipped

- Helps track equipment and manage safety inspection programs.



## BONUS

Harness storage bag with every Delta™ harness

# Body Harnesses

## 3M™ DBI-SALA® Delta™ Riggers Harness

Ideal for use in rigging, confined space, ladder access and general height safety.

Large rear fall arrest rated stand-up D-ring, front fall arrest rated D-ring, confined space attachment points, quick-connect buckles, corrosion resistant hardware, fully adjustable.



3M Order Code	Model #	Size
70007941654	803XS0018	Extra Small
70007926416	803S0018	Small
70007925822	803M0018	Medium
70007925707	803L0018	Large
70007925046	803XL0018	Extra Large

## 3M™ DBI-SALA® Delta™ Riggers Harness with Stainless Steel Hardware

Ideal for use in rigging, confined space, ladder access and general height safety.

Large rear fall arrest rated Stainless Steel D-ring, front fall arrest rated D-ring, confined space attachment points, stainless Steel 2/3 bar buckles, corrosion resistant hardware, fully adjustable.



3M Order Code	Model #	Size
70007930970	803S1022	Small
70007930970	803M1022	Medium
70007926424	803L1022	Large
70007938528	803XL1022	Extra Large

## 3M™ DBI-SALA® Delta™ Cross-Over Harness

Ideal for use in roof construction, maintenance and ladder access work.

Large rear fall arrest rated stand-up D-ring, front fall arrest D-ring, quick-connect buckles, corrosion resistant hardware, fully adjustable.



3M Order Code	Model #	Size
70007946844	813XS0016	Extra Small
70007934378	813S0016	Small
70007932083	813M0016	Medium
70007925251	813L0016	Large
70007946752	813XL0016	Extra Large

## 3M™ DBI-SALA® Delta™ All Purpose Harness

Ideal for use in multi purpose access including confined space entry, rigging, ladder access work and work positioning at height.

Large rear fall arrest rated stand-up D-ring, front fall arrest rated D-ring, confined space attachment points, waist belt with side D-rings, quick-connect buckles, corrosion resistant hardware, fully adjustable.



3M Order Code	Model #	Size
70007930806	823S0018	Small
70007925855	823M0018	Medium
70007925616	823L0018	Large
70007927141	823XL0018	Extra Large

## 3M™ DBI-SALA® Delta™ Tower Workers Harness

Ideal for use by telecommunications and power industry personnel when working on towers and poles.

Large rear fall arrest rated stand-up D-ring, frontal fall arrest/belay loops, confined space attachment points, padded waist belt with side D-rings, pole/restraint D-rings, quick-connect buckles, corrosion resistant hardware, fully adjustable.



3M Order Code	Model #	Size
70007936365	853S0018	Small
70007925160	853M0018	Medium
70007928818	853L0018	Large
70007932042	853XL0018	Extra Large

## 3M™ DBI-SALA® Delta™ Miners Harness

Ideal for use by mining industry personnel for use with battery packs and self rescuers.

Large rear fall arrest rated stand-up D-ring, front fall arrest rated D-ring, confined space attachment points, integral miners belt with battery and self rescue straps, reflective tape, suspension trauma straps, quick-connect buckles, corrosion resistant hardware, fully adjustable.



3M Order Code	Model #	Size
70007947362	823S0035	Small
70007934790	823M0035	Medium
70007929410	823L0035	Large
70007932737	823XL0035	Extra Large

Also available: models with additional features suitable for specific industry applications

# Body Harnesses

## 3M™ DBI-SALA® Delta™ Live Line & Standard Linesman Harness (Resistant to electrical conductivity)\*

Ideal for use when working on high and low voltage live lines from an EWP vehicle.

Rear fall arrest rated webbing loop with integrated dorsal extension, frontal fall arrest/belay loops, confined space attachment points, leather insulators, no metal hardware above the waist, quick-connect buckles, corrosion resistant hardware, fully adjustable.

\*No metal hardware above the waist



3M Order Code	Model #	Size
70007937165	803S0009	Small
70007935292	803M0009	Medium
70007937082	803L0009	Large
70007937090	803XL0009	Extra Large

## 3M™ DBI-SALA® Delta™ Riggers Comfort Harness

Ideal for use in rigging, confined space, ladder access and general height safety.

Large rear fall arrest rated D-ring, front fall arrest rated D-ring, confined space attachment points, quick connect buckles, aluminium hardware, fully adjustable, built-in shoulder, back and leg comfort padding.



3M Order Code	Model #	Size
70007937728	833S2018	Small
70007927455	833M2018	Medium
70007931218	833L2018	Large
70007935573	833XL2018	Extra Large

## 3M™ DBI-SALA® Delta™ Cross-Over Comfort Harness

Ideal for use in roof construction, maintenance and ladder access work.

Large rear fall arrest rated D-ring, front fall arrest rated D-ring, quick-connect buckles, corrosion resistant hardware, fully adjustable, built-in shoulder, back and leg comfort padding.



3M Order Code	Model #	Size
70007943221	843S2016	Small
70007935714	843M2016	Medium
70007950911	843L2016	Large
70007935722	843XL2016	Extra Large

## 3M™ DBI-SALA® Delta™ Welders Harness\*

Ideal for use in 'Hot Work' and arc flash environments.

Rear stand-up D-ring, front fall arrest rated loops, confined space loops, Nomex®/Kevlar® fibre webbing, dielectric hardware.

Note: Specially designed Welders Lanyards are also available to complement/use with this harness.

\*Arc flash, flame, heat and cut resistant



3M Order Code	Model #	Size
70007932851	320S2066NK	Small
70007927729	320M2066NK	Medium
70007930459	320L2066NK	Large
70007945218	320XL2066NK	Extra Large

Also available: models with additional features suitable for specific industry applications



# Body Harnesses



## 3M™ DBI-SALA® Fall Protection Kits

Suited for specific worker applications, our kits include all the necessary components of the ABC of fall protection to ensure worker safety.



3M Order Code	Model #	Description
70007930988	1900-0004	<b>Construction Workers Kit</b> , includes: 823M0018 (DBI SALA Delta All Purpose Harness), E849-015 (DBI SALA Tie off Adaptor), Z90203636 (DBI SALA EZ Stop Shock Absorbing Webbing Lanyard), 1900-0000 Equipment/Kit Bag, 3101615 ( DBI-SALA Nano-Lok™ Extended Length Single Leg SRL with Quick Connector). Also available with small, large or extra large harness.
70007928529	1900-0005	<b>Professional Roof Workers Kit</b> , includes: Harness (814M116) Yellow, E849-015, P6711-015-36-58, R-308 (DBI SALA Double Action Autolock Carabiner), Z90103636, 1900-0000 Equipment / Kit Bag. Also available with small, large or extra large harness.
70007948238	1900-0027	<b>Professional Roof Workers Kit without harness</b> , includes: Z90103636 EZ-Stop™ 1.0 m Lanyard, P6711-015-36-58 15 m Rope and Rope Grab, R-105-S Screw Gate Karabiner, E849-015 Tie-Off Adaptor, 1900-0000 Equipment / Kit Bag

## 3M™ DBI-SALA® Miners Belts



E100M-0837

E100M-0179



E112M-0033



E100M-0051



3M Order Code	Model #	Description
70007928412	E100M-0051	Medium, with rear D-ring, battery pack and self rescue straps with velcro, reflective tape on rear
70007937843	E100M-0179	Medium, with rear D-ring, fixed braces, battery pack and self rescue straps with velcro, reflective tape on front and rear
70007939047	E100M-0837	Medium, with 2 front D-rings, detachable braces, battery pack and self rescue straps, reflective tape on front and rear
70007942058	E112M-0033	Medium, with detachable battery pack and self rescue straps, 2 front D-rings, reflective tape along entire length of belt

Note: Miners belts are available in small, medium, large and extra large sizes.

**Also available: models with additional features suitable for specific industry applications**

# 3M™ Protecta™ P200 Full-Body Harnesses

3M™ Protecta P200 fall arrest harnesses provide reliable protection, comfort and convenience; now with upgraded features and a sleek, modern look – all at an affordable price.

Available in a variety of styles and configurations, these new harnesses have enhanced features including quick connect buckles, auto-resetting lanyard keepers as well as softer and more durable hip padding.

### Features and Benefits:

- **D-Ring Placement**  
Conveniently placed front fall arrest D-ring helps you stay balanced and centred.
- **Auto-resetting Lanyard Keepers**  
Provides easy parking and release of snap hooks, scaffold hooks or Karabiners.
- **Impact Indicators**  
Make it simple to inspect the harness for damage and help ensure it's safe to use
- **Modern Black Components**  
Zinc plated steel with electro deposit paint finish
- **Protected Labels**  
For long-term identification and inspection
- **Comfort Padding**  
Softer and more robust hip pad is 3x thicker\* for extra comfort
- **EZ-Link SRL Adapter**  
Integrated easy-link web SRL adapter lets you quickly and easily connect and disconnect personal SRL's \*\*
- **Improved Belt**  
Durable and sturdy belt for tool bag carrying convenience\*
- **Gear Tool Loops\*\***  
Tools can be secured while working at heights, to keep people and property safe anywhere below you

\*\* On selected models



# Body Harnesses

## 3M™ Protecta® P200 Riggers Harness

- Quick connect buckles
- Rear fall arrest D-ring
- Front and rear adjustable chest strap
- Soft EZ-link SRL adapter



3M Order Code	Model #	Size
AT010644295	1161672	Small
AT010644303	1161673	Medium
AT010644311	1161674	Large
AT010644329	1161675	Extra Large

## 3M™ Protecta® P200 Riggers Harness with Pads

- Quick connect buckles
- Rear fall arrest D-ring
- Front and rear adjustable chest strap
- Comfort padding
- Soft EZ-link SRL adapter



3M Order Code	Model #	Size
AT010644337	1161676	Small
AT010644345	1161677	Medium
AT010644352	1161678	Large
AT010644360	1161679	Extra Large

## 3M™ Protecta® P200 All Purpose Harness

- Quick Connect buckles
- Front and Rear fall arrest D-ring
- Comfort padding
- Soft EZ-link SRL adapter
- Padded Waist belt with Side D rings



3M Order Code	Model #	Size
AT010644378	1161680	Small
AT010644386	1161681	Medium
AT010644394	1161682	Large
AT010644402	1161683	Extra Large

## 3M™ Protecta® P200 Riggers Harness with Stainless Steel Hardware & Pass Through Buckles

- Pass through buckles
- Front and Rear fall arrest D-rings
- Adjustable chest strap



3M Order Code	Model #	Size
AT010644170	1161660	Small
AT010644188	1161661	Medium
AT010644196	1161662	Large
AT010644204	1161663	Extra Large

## 3M™ Protecta® P200 Riggers Harness with Stainless Steel Hardware

- Quick Connect buckles
- Front and Rear fall arrest D-ring
- Adjustable chest strap height



3M Order Code	Model #	Size
AT010644212	1161664	Small
AT010644220	1161665	Medium
AT010644238	1161666	Large
AT010644246	1161667	Extra Large

## 3M™ Protecta® P200 Riggers Harness with Pads & Stainless Steel Hardware

- Quick Connect buckles
- Front and Rear fall arrest D-ring
- Adjustable chest strap
- Comfort padding



3M Order Code	Model #	Size
AT010644253	1161668	Small
AT010644261	1161669	Medium
AT010644279	1161670	Large
AT010644287	1161671	Extra Large

# Body Harnesses

## 3M™ Protecta® P200 Miners Harness

- Quick Connect buckles
- Integrated miners belt
- Comfort padding
- Soft EZ-link SRL adapter
- Front and Rear Fall Arrest D Rings



3M Order Code	Model #	Size
AT010644410	1161684	Small
AT010644428	1161685	Medium
AT010644436	1161686	Large
AT010644444	1161687	Extra Large

## 3M™ Protecta® P200 Welders Harness

- Quick Connect buckles
- Meta Aramid/Kevlar webbing
- Front and Rear Fall Arrest D rings



3M Order Code	Model #	Size
AT010644451	1161688	Small
AT010644469	1161689	Medium
AT010644477	1161690	Large
AT010644485	1161691	Extra Large

## 3M™ Protecta® P200 Tower Workers Harness with D-Rings

- Quick connect buckles
- Rear fall arrest D-ring
- Adjustable chest strap
- 2 x work positioning D-rings
- Soft Sternum Fall Arrest Loops
- Padded Waist Belt



3M Order Code	Model #	Size
AT010644493	1161692	Small
AT010644501	1161693	Medium
AT010644519	1161694	Large
AT010644527	1161695	Extra Large

## 3M™ Protecta® P200 Tower Workers Harness with O-Rings

- Quick connect buckles
- Rear fall arrest D-ring
- Adjustable chest strap
- 2 x work positioning O-rings
- Soft Sternum Fall Arrest Loops
- Padded Waist Belt
- 300mm dorsal extension
- Tool Loops



3M Order Code	Model #	Size
AT010644535	1161696	Small
AT010644543	1161697	Medium
AT010644550	1161698	Large
AT010644568	1161699	Extra Large

## 3M™ Protecta® P200 Live Line Harness

- Quick connect buckles on legs only
- Only plastic coated hardware above the waist
- 300mm dorsal extension
- Leather insulation on metal components



3M Order Code	Model #	Size
AT010644659	1161708	Small
AT010644667	1161709	Medium
AT010644675	1161710	Large
AT010644683	1161711	Extra Large

## 3M™ Protecta® P200 Y Back Harness

3M™ Protecta X Y-Back Utility fall arrest harnesses provide reliable protection, comfort, convenience and ease of use; now with upgraded features and a sleek, modern look – all at an affordable price.



3M Order Code	Model #	Size
AT010791534	1161771	Small
AT010791542	1161772	Medium
AT010791559	1161773	Large
AT010791567	1161774	X-Large



# 3M™ Protecta® P100 Harnesses

Quality and safety for everyday workers.

Full-body harnesses are genuine working tools that allow you to get on with your job without worrying about safety. That's why our all new re-designed and upgraded 3M™ Protecta® P100 Full-Body Harness Range offers a choice of harnesses for every possible working environment, from general construction to tower work.

### Features and Benefits:

#### Buckle Options

- Pass Through for simple, safe connection.

#### Chest Strap

- Optimum position for connection to lanyards and systems.
- Keeps connectors out of the users face.

#### Easy adjust Torso Buckles.

- Easier to adjust with pull down adjustment.

#### Webbing Management

- Spare torso webbing stored through hip strap.
- All stitch blocks are away from the body for greater comfort.

#### Contrasting

##### Leg & Chest Strap

- Reduces donning time.

#### Large Rear D-ring

- Easier to connect, increased safety.
- Can be used for rescue.

#### Protected Labels

- Protective Velcro® sealed pouch.
- Ensures easy identification and inspection.



# Body Harnesses

## 3M™ Protecta® P100 Riggers Harness

Ideal for rigging, rescue, construction, elevated work platforms, ladder access work, confined space access and general height safety.

Front & rear fall arrest rated D-ring, confined space attachment points, easy adjust hardware, sub-pelvic strap, adjustable chest, shoulder & leg straps.



3M Order Code	Model #	Size
70007951984	AB123S	Small
70007950937	AB123M	Medium
70007951695	AB123L	Large
70007953014	AB123XL	Extra Large

## 3M™ Protecta® P100 All Purpose Harness

Ideal for use in multi purpose applications including confined space entry, rigging, construction, ladder access work positioning and general height safety.

Front & rear fall arrest rated D-ring, confined space attachment points, easy adjust hardware, sub-pelvic strap, integrated shoulder & lower back/hip pads, adjustable chest, shoulder & leg straps.



3M Order Code	Model #	Size
70008280474	AB124S	Small
70007950929	AB124M	Medium
70007952594	AB124L	Large
70007953048	AB124XL	Extra Large

## 3M™ Protecta® P100 Riggers Harness with Adjustable Integral Lanyard



3M Order Code	Model #	Size	Connector
70804400706	AB126-36S	Small	Snap Hook
70008280060	AB126-36M	Medium	Snap Hook
70007952867	AB126-36L	Large	Snap Hook
70804400714	AB126-36XL	Extra Large	Snap Hook
70804400672	AB126-34M	Medium	Scaffold Hook
70804400664	AB126-34L	Large	Scaffold Hook
70804400698	AB126-34XL	Extra Large	Scaffold Hook

## 3M™ Protecta® P100 Riggers Harness With Elasticated Integral Lanyard



3M Order Code	Model #	Size	Connector
70804400763	AB127-36M	Medium	Snap Hook
70804400755	AB127-36L	Large	Snap Hook
70007952982	AB127-34M	Medium	Scaffold Hook
70804400722	AB127-34L	Large	Scaffold Hook

## 3M™ Protecta® P100 Tower Workers Harness

Ideal for use in linesman/tower work, and industries where a harness must be used for climbing, suspension, positioning or rescue

Front & dorsal fall arrest rated D-ring, pelvic strap, confined space attachment points, adjustable waist belt, leg, shoulder & chest straps, side D-rings, tool loops, integral rear extension, pole / restraint side attachment points, work positioning buttock seat, wide padded lower back pad



3M Order Code	Model #	Size
70007952859	AB129-2M	Medium
70007951976	AB129-2L	Large
70804400821	AB129-2XL	Extra Large

## 3M™ Protecta® P100 Fall Protection Kits



### Pro Construction Workers Kit

3M Order Code	Model #	Description
70007930384	AA410AU	Pro Climbing Harness (AB123M), 3.3 m Rebel Personal SRL (3100447), 1.5 m round anchor strap (1003584), backpack storage bag

### Pro Roof Workers Kit

3M Order Code	Model #	Description
70007928479	AA400AU	Pro Climbing Harness (AB123M), 15 m kernmantle rope lifeline with 0.55 m integral shock absorbing lanyard, 1.5 m tie-off adaptor anchor strap (AM500/150AU), backpack storage bag

# 3M™ Protecta® P50 All Purpose Harness

Fall protection that's there when you need it.

Every at height worker deserves to be safe, no matter the size or nature of the job. That's why Protecta® products have become the choice of safety managers looking for reliable fall protection solutions that comply with safety regulations and help their workers get the job done.

### Features and Benefits:

#### Multiple attachment points

- Front, rear, side D-rings for multiple work positions.

#### Confined space access

- Shoulder retrieval attachment points.
- Added comfort  
Waist belt and padded hip/lower back pad.





# Body Harnesses

## 3M™ Protecta® P50 All Purpose Harness

Construction harness with front, rear, side D-rings, confined space attachment points, waist belt and padded hip/lower back pad.



3M Order Code	Model #	Description
AT010621582	1390062A	Universal

## 3M™ Protecta® P50 Riggers Harness

Industrial harness with front and rear fall arrest rated D-ring, adjustable leg and chest straps, Sub pelvic Strap.



3M Order Code	Model #	Description
AT010621574	1390061A	Universal

## Riggers harness with adjustable 2m integral lanyard w/snap hook



3M Order Code	Model #	Description
AT010621590	1390063A	Universal

## Riggers harness with adjustable 2m integral lanyard w/scaffold hook



3M Order Code	Model #	Description
AT010621608	1390064A	Universal

## 3M™ Protecta® P50 Fall protection Kits

### First™ Construction Workers Kit

3M Order Code	Model #	Description
70007929576	AA1020AU	P50 Fall Arrest Harness (AB17510AU), 1.8 m Rebel Personal SRL (3100445), 1.5 m round anchor strap (1003584), packed in a rugged re-useable carry bucket

### First™ Roof Workers Kit

3M Order Code	Model #	Description
70007925012	AA1000AU	P50 Fall Arrest Harness (AB17510AU), 15 m kernmantle rope lifeline with 1 m integral shock absorbing lanyard, 1.5 m round anchor strap (1003584), packed in a rugged re-useable carry bucket



AA1000AU



# Connectors

Specific jobsites call for unique connectors. That's why we developed a comprehensive product range, all rigorously tested to meet almost all applications.

# Unique risks of leading and sharp edges:

## 1 Increased fall distance

Anchoring at foot level increases the distance needed for fall clearance.

When workers are attached at foot-level, as they often are in leading edge applications, they will fall farther than they would if they were anchored at shoulder height or above. The required clearance when anchored at foot-level varies by product so make sure to reference the products' user instructions.

## 2 Lock-up speed

Required time to reach velocity to engage lifeline takes longer because of longer fall distance.

Self-retracting lifelines react to a fall when the lifeline accelerates out of the housing at a certain velocity. When self-retracting lifelines are anchored at foot-level, the lifeline does not achieve the required acceleration during a fall until after the user's D-ring passes over the leading edge and below the level of the anchor. This means the user has already fallen approximately 1.5 meters before the self-retracting lifeline device will engage to arrest the fall.

## 3 Increased fall arrest forces

Potentially higher impact to the body when the fall is arrested.

Falling further means the impact on the body through the fall protection system will potentially be greater when the fall is arrested. This is why leading edge Self Retracting Lifelines are designed with an energy absorber at the end of the lifeline, or as an integrated back-pack style, that connects to the users harness.

## 4 Increased potential for swing hazards

This could create a sawing action on a lifeline strung taut over a sharp edge.

Depending on a worker's position during a fall, they may swing like a pendulum after the fall is arrested. While swinging is a hazard under any circumstances, the danger is compounded if the worker's lifeline is strung taut over a sharp edge and saws back and forth across that edge.

## 3M™ DBI-SALA® Force2™ Shock Absorbing Lanyards

Built for toughness and exceptional performance - trust the best!

All DBI-SALA Force2 shock absorbing lanyards are available in either single or double tail configurations constructed from webbing, wire or rope in a variety of styles (elasticated, non-elasticated, adjustable and tie-back), and are available with a wide combination of hook & karabiner terminations to suit your specific needs and applications.

### Choosing a lanyard

Look for quality in these features when selecting a lanyard.

#### A. Webbing

Choose your webbing based on the type of conditions you work in. Options include Nomex®, Kevlar®, Kermantle rope and cable

#### B. Connector/hook

Expanded range of 3M™ DBI-SALA® Connectors allowing for one-handed use, won't pinch thumbs or fingers, for all industry applications and demands

#### C. Length

The standard lanyard length is 2m, but other lengths are available

#### D. Shock absorber

Smallest Shock absorber in the world, with HI-10™ high tenacity fibre energy management material, keeps forces below 6kN. For user weights up to 160kg

#### E. Labelling

Product data protected from everyday use, RFID equipped



### Types of 3M™ DBI-SALA® Connectors

Expanded range of DBI-SALA Connectors includes triple action snap and scaffold hooks plus transverse loading options. All of our connectors feature 16kN rated gates.

	Steel Snap Hook	Aluminium Snap Hook	Stainless Steel Snap Hook	Aluminium Snap Hook Triple Action	Aluminium Scaffold Hook	Steel Scaffold Hook	Saflok Max Steel Rebar Hook	Saflok Tower Hook	Aluminium Scaffold Hook Triple Action	Comfort Grip Hook	Steel Karabiner Triple Action	Stainless Steel Karabiner Triple Action	Aluminium Karabiner Triple Action	Aluminium Karabiner Triple Action with Eye
Gate Opening	19mm	19mm	19mm	20mm	57mm	64mm	87mm	116.84mm	63.5mm	57mm	20mm	20mm	18mm	18mm
Gate Strength	16kN	16kN	16kN	16kN	16kN	16kN	16kN	16kN	16kN	16kN	16kN	16kN	16kN	16kN
Model #	9502116	9505254	9505253	2000183	9502058	2109193	2000125	2000194	2000182	2000214	R-113	R-119	2000184	8700552

## 3M™ DBI-SALA® Force2™ Shock Absorbing Lanyards



### 3M™ DBI-SALA® Force2™ Shock Absorbing Webbing Lanyards



3M Order Code	Model #	Description	Single-Leg/ Twin-Leg	Connector 1 (Harness)	Connector 2 (Anchor)
70007926861	Z10200909	Non Adjustable, 2.0m with double action snap hooks on all connections	Single	9502116	9502116
70007934618	Z10200909E	Elasticated, 2.0m with double action snap hooks on all connections	Single	9502116	9502116
70007932232	Z10202519E	Elasticated, 2.0m with aluminium snap hook and scaffold hook	Single	9505254	9502058
70007947081	Z11202525	Adjustable, 2.0m with aluminium snap hooks on all connections	Single	9505254	9505254
70007925681	Z11200919	Adjustable, 2.0m with double action snap hook and scaffold hook	Single	9502116	9502058
70007928388	Z11206161	Adjustable, 2.0 with aluminium triple action karabiners on all connections	Single	8700552	8700552
AT019425530	Z10200980E	Elasticated 2.0m with double action snap and comfort hook	Single	9502116	2000214
70007945655	Z12202519	Non Adjustable 2.0m with aluminium double action snap hook and scaffold hooks	Twin	9505254	9502058
70007925418	Z12202519E	Elasticated, 2.0m with aluminium double action snap hook and scaffold hooks	Twin	9505254	9502058
70804412545	Z12206129E	Elasticated, 2.0m with aluminium triple action karabiner and scaffold hooks	Twin	8700552	2000182
70007941621	Z13200919	Adjustable, 2.0m with double action snap hook and scaffold hooks	Twin	9502116	9502058
70804412677	Z13202525	Adjustable, 2.0m with aluminium double action snap hooks on all connections	Twin	9505254	9505254
70007963815	Z13204545	Adjustable, 2.0m with stainless steel triple action karabiners on all connections	Twin	R-119	R-119
70007964623	Z13206129	Adjustable, 2.0m with aluminium triple action karabiner and triple action scaffold hooks	Twin	8700552	2000182
AT019425597	Z12202580E	Elasticated 2.0m with aluminium double action snap hook and comfort hook	Twin	9505254	2000214

### 3M™ DBI-SALA® Force2™ Shock Absorbing Wind Energy Rescue Lanyards

Incorporating rescue D-rings and heavy duty wear pads, this lanyard has been specifically designed and developed to meet the demands of the wind energy industry.



3M Order Code	Model #	Description	Single-Leg/ Twin-Leg	Connector 1 (Harness)	Connector 2 (Anchor)
70007930707	Z12200929EW	Elasticated, 2.0m with double action snap hook and scaffold hooks	Twin	9502116	9502058
AT010782954	Z12202580EW	Elasticated, 2.0m with aluminium snap hook and comfort hooks	Twin	9505254	2000214

\* DBI-SALA Shock Absorbing Lanyards are available in a range of lengths, with alternate hook and karabiner terminations to suit your specific needs and application. Contact 3M Customer Service or your local 3M Fall Protection expert for more information. All twin tail lanyards are supplied with E839 lanyard stowage points. If a dorsal extension is part of your harness the maximum lanyard assembly permitted is 1.7m or less.

## 3M™ DBI-SALA® Force2™ Shock Absorbing Rope & Cable Lanyards



### 3M™ DBI-SALA® Force2™ Shock Absorbing Rope Lanyards



3M Order Code	Model #	Description	Single-Leg/ Twin-Leg	Connector 1 (Harness)	Connector 2 (Anchor)
70007931960	Z10200909R	Non-adjustable, 2.0m with double action snap hooks on all connections	Single	9502116	9502116
70007954202	Z10202519R	Non-adjustable, 2.0m with aluminium double action snap hook and scaffold hook	Single	9505254	9502058
70007925475	Z11204545R	Adjustable, 2.0m with stainless steel triple action karabiners on all connections	Single	R-119	R-119
70007935094	Z11206119R	Adjustable, 2.0m with aluminium triple action karabiner and scaffold hook	Single	8700552	9502058
70007934345	Z11206159R	Adjustable, 2.0m with aluminium triple action karabiner on all connectors	Single	8700552	2000184
70007929956	Z11204545CR	Cut Resistant, Adjustable, 2.0m with stainless steel triple action karabiners on all connections	Single	R-119	R-119
70007963344	Z11206119CR	Cut Resistant, Adjustable, 2.0m with aluminium triple action karabiner and scaffold hook	Single	8700552	9502058
70007943833	Z11206159CR	Cut Resistant, Adjustable, 2.0m with aluminium triple action karabiner on all connectors	Single	8700552	2000184
70007925889	Z12202519R	Non Adjustable, 2.0m with aluminium snap hook and scaffold hooks	Twin	9505254	9502058
70007957486	Z13204545R	Adjustable, 2.0m with stainless steel triple action karabiners on all connections	Twin	R-119	R-119
70007940854	Z13206119R	Adjustable, 2.0m with aluminium triple action karabiner and scaffold hooks	Twin	8700552	9502058
70007927190	Z13206129R	Adjustable, 2.0m with aluminium triple action karabiner and triple action scaffold hooks	Twin	8700552	2000183
70007938791	Z13206159R	Adjustable, 2.0m with aluminium triple action karabiners on all connections	Twin	8700552	2000184
70007937348	Z13206119CR	Cut Resistant, Adjustable, 2.0m with aluminium triple action karabiner and scaffold hooks	Twin	8700552	9502058

### 3M™ DBI-SALA® Force2™ Shock Absorbing Lanyards - Wire Cable - Double Tail



3M Order Code	Model #	Description	Single-Leg/ Twin-Leg	Connector 1 (Harness)	Connector 2 (Anchor)
70007930087	Z10200909WR	PVC Coated, 2.0m with double action snap hooks on all connections	Single	9502116	9502116
70007939757	Z10204545WR	PVC Coated, 2.0m with stainless steel triple action karabiners on all connections	Single	R-119	R-119
70007950341	Z10207575WR	PVC Coated, 2.0m with triple action karabiners on all connections	Single	R-113	R-113
70007940987	Z12200919WR	PVC Coated, 2.0m with double action snap hook and scaffold hooks	Twin	9502116	9502058
70007950010	Z12204545WR	PVC Coated, 2.0m with stainless steel triple action karabiners on all connections	Twin	R-119	R-119
70007955993	Z12207575WR	PVC Coated, 2.0m with triple action karabiners on all connections	Twin	R-113	R-113

\* DBI-SALA Shock Absorbing Lanyards are available in a range of lengths, with alternate hook and karabiner terminations to suit your specific needs and application. Contact 3M Customer Service or your local 3M Fall Protection expert for more information. All twin tail lanyards are supplied with E839 lanyard stowage points. If a dorsal extension is part of your harness the maximum lanyard assembly permitted is 1.7m or less.

## 3M™ DBI-SALA® EZ-Stop Shock Absorbing Lanyards



Z60200919NKE

Z90200909NKE

Z51203636

Z60203634E

### 3M™ DBI-SALA® EZ-Stop™ Shock Absorbing Lanyards Webbing



3M Order Code	Model #	Description	Single-Leg/Twin-Leg	Connector 1 (Harness)	Connector 2 (Anchor)
70007926887	Z51203636	Adjustable, 2.0m with double action snap hooks on all connections	Single	2000161	2000161
70007927695	Z90203636	Non-Adjustable, 2.0m with double action snap hook on all connections	Single	2000161	2000161
70007936209	Z90203634	Non-Adjustable, 2.0m with double action snap hook and scaffold hook	Single	2000161	2000164
70007930004	Z90203636E	Elasticated, 2.0m with double action snap hook on all connections	Single	2000161	2000161

### 3M™ DBI-SALA® EZ Stop Shock Absorbing Welders Lanyards

High temperature lanyards constructed from Nomex®/Kevlar® fibre webbing, ideal if you are welding, cutting or grinding, or in a potentially explosive or high-voltage electrical environment.



3M Order Code	Model #	Description	Single-Leg/Twin-Leg	Connector 1 (Harness)	Connector 2 (Anchor)
70007926812	Z90200909NK	Non adjustable, 2.0m with with double action snap hooks on all connections	Single	9502116	9502116
70007930814	Z90200909NKE	Elasticated 2.0m with double action snap hooks on all connections	Single	9502116	9502116
70007959086	Z90204545NKE	Non adjustable 2.0m with stainless steel triple action karabiners on all connections	Single	R-119	R-119
70007925327	Z60200919NKE	Elasticated 2.0m with double action snap hook and scaffold hooks	Twin	9502116	9502058
70007937413	Z60204545NKE	Elasticated 2.0m with stainless steel triple action karabiners on all connections	Twin	R-119	R-119

Nomex® and Kevlar® are registered trademarks of E.I. du Pont de Nemours and Company.

## 3M™ DBI-SALA® Pole Straps and Lifelines



### 3M™ DBI-SALA® Webbing Pole Straps



3M Order Code	Model #	Description	Connector 1	Connector 2
70007927653	E601-020	2.0m with double action snap hooks on all connections	2000161	2000161
70007930186	E601-025	2.5m with double action snap hooks on all connections	2000161	2000161
70007925178	E601-030	3.0m with double action snap hooks on all connections	2000161	2000161
70007947685	E601-035	3.5m with double action snap hooks on all connections	2000161	2000161
AT010644782	E613B0202525	2.0m with aluminium double action snap hooks on all connections	9505254	9505254
70007937801	E613B0351717	3.5m with red aluminium double action snap hooks on all connections	2000168	2000168
70804402686	E613BLU0301818	3.0m with blue aluminium double action snap hooks on all connections	2000167	2000167
70007935672	E613BLU0351818	3.5m with blue aluminium double action snap hooks on all connections	2000167	2000167
AT010643933	E613-BLU-035-61-18	3.5m with blue aluminium double action snap hook and aluminium triple action karabiner	8700552	2000167
70007934550	E613RPY0250909	2.5m with double action snap hooks on all connections	9502116	9502116
70007937827	E613RPY0300909	3.0m with double action snap hooks on all connections	9502116	9502116
70007940730	E613RPY0350909	3.5m with double action snap hooks on all connections	9502116	9502116

### 3M™ DBI-SALA® Rope Pole Straps\*



3M Order Code	Model #	Description	Connector 1	Connector 2
70007930731	E90204545	2.0m with stainless steel triple action karabiners on all connections	R-119	R-119
70007960233	E90254545	2.5m with stainless steel triple action karabiners on all connections	R-119	R-119
70007945804	E90202559	2.0m with double action snap hook and triple action karabiner	9505254	2000184
70007927687	E90252559	2.5m with double action snap hook and triple action karabiner	9505254	2000184
70007950457	E90207575	2.0m with triple action karabiners on all connections	R-113	R-113
70007940615	E90257575	2.5m with triple action karabiners on all connections	R-113	R-113

### 3M DBI-SALA Lifeline Assembly Systems

3M™ DBI-SALA® 11mm Kernmantle rope lifeline with sewn thimbled eye, fitted with connector at one end and sewn end stop on the other, rope adjuster.



P6711-015-36-58



3M™ DBI-SALA® 11mm Kernmantle rope lifeline with sewn thimbled eye, fitted with connector at one end and sewn end stop on the other, rope adjuster with shock absorber fitted with connector.



P67110100958Z



3M Order Code	Model #	Length	Connector
70007950473	P6711-003-36-58	3m	2000161
70007939708	P6711-005-36-58	5m	2000161
70007945432	P6711-010-36-58	10m	2000161
70007927182	P6711-015-36-58	15m	2000161
70007940722	P6711-020-36-58	20m	2000161
70007929451	P6711-025-36-58	25m	2000161
70007939039	P6711-030-36-58	30m	2000161
70007948220	P6711-040-36-58	40m	2000161

3M Order Code	Model #	Length	Connector
70007955258	P67110100958Z	10m	9502116
70007939716	P6711-002-75-58Z	2m	R-113
70007943007	P67110057558Z	5m	R-113
70007940540	P6711-006-36-58Z	6m	2000161
70007931895	P6711-015-75-58Z	15m	R-113
70007947743	P67110203658Z	20m	2000161
70007937421	P67110253658Z	25m	2000161
70007961629	P67110307558Z	30m	R-113
70007945796	P67110503658Z	50m	2000161

\* DBI-SALA Pole Straps and Lifelines are available in a range of lengths, with alternate hook and karabiner terminations to suit your specific needs and application. Contact 3M Customer Service or your local 3M Fall Protection expert for more information.



## 3M DBI-SALA® Personal Self Retracting Lifelines

### 3M™ DBI-SALA® Nano-Lok™ LE Self-Retracting Lifelines

#### Integrated, backpack-style Energy Absorber

- Energy absorber and connector work together to limit forces on both the worker and the impacted edge.
- Backpack design stays tight to the harness and helps evenly distribute units weight

#### Easy-to-install connector

- Provides 360 degrees of rotation, the direct-to-harness connection provides seamless integration of the energy absorber and leaves the D-ring open for rescue or other equipment

#### Sharp Edge Icon

- Global sharp edge icon to quickly and easily identify sharp edge products

#### Tough and flexible webbing or galvanized cable lifelines

- 2.4m of 5mm cable or 20mm Kevlar®/Dyneema fibre webbing provides maximum range of motion, durability and cut resistance

#### Impact-resistant housing

- Lightweight thermoplastic housing provides maximum durability

Compliant to AS 1891.3:2020 Amd1:2021

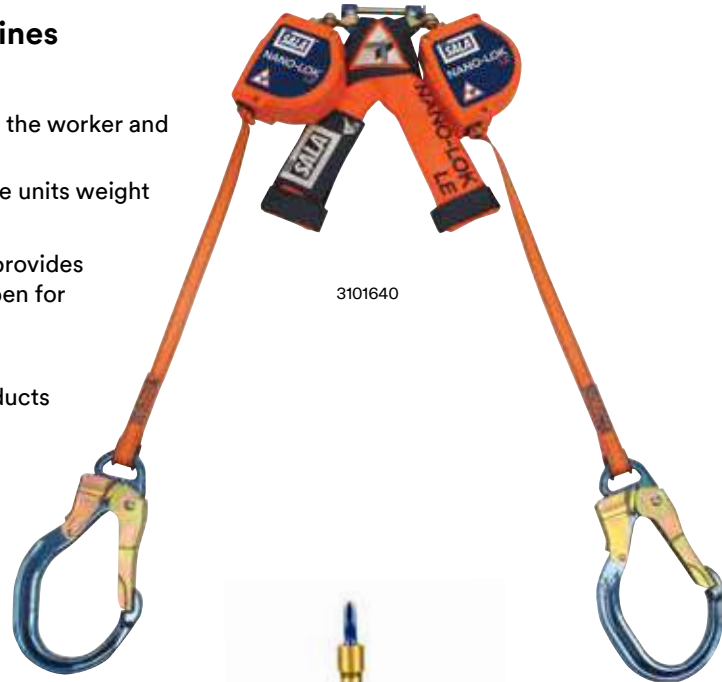

3101640

### 3M™ DBI-SALA® Nano-Lok 2G Self-Retracting Lifelines

#### High capacity external energy absorber and impact indicator

- Specialised built-in external absorption system maintains safe fall arrest forces for users and tools up to 140 kg and provides a visual alert that the SRL has been involved in a fall

#### 1.8m 19mm Dynema polyester web lifeline

- The synthetic lifeline reduces overall weight and the retractable design provides freedom of movement, keeps the lifeline out of the worker's way and reduces dragging, snagging and trip falls.

#### Tough and impact resistant thermoplastic housing

- Compact and durable housing is designed to withstand the demands of challenging jobsites, it's built to last.

#### Wide variety of configurations available

- There are a wide variety of models to choose from to suit almost any application for complete jobsite versatility and flexibility

#### Fast connection system

- Simple, light-weight connector allows backward compatibility

Compliant to AS 1891.3:2020 Amd1:2021



3101709

	Steel Snap Hook	Steel Snap Hook Tie Back	Aluminium Scaffold Hook	Steel Scaffold Hook	Aluminium Scaffold Hook	Comfort Grip Hook	Aluminium Scaffold Hook	Steel Karabiner Double Action	Steel Karabiner Triple Action	Stainless Steel Karabiner Triple Action	Aluminium Karabiner Triple Action	Cab Mount
Gate Opening	19mm	19mm	57mm	64mm	57mm	57mm	63.5mm	17mm	20mm	20mm	18mm	N/A
Gate Strength	16kN	16kN	16kN	16kN	16kN	16kN	16kN	16kN	16kN	16kN	16kN	N/A
Model #	9502116	9501804	9502058	2109193	2007153	2000214	2000209	2000112	R-113	R-119	2000184	3100144
												N/A

	Steel Fast Connection System	Steel Direct Connect	Steel Direct Connect	Steel Direct Connect	Steel Twin Connector
Model #	3100480	3100127	3100064	3100088	3100109



3100480



3100088

## 3M™ DBI-SALA® Nano-Lok™ Self Retracting Lifelines



### 3M™ DBI-SALA® Nano-Lok™ LE Self-Retracting Lifelines

3M Order Code	Model #	Description	Single-Leg/Twin-Leg	Connector 1 (Housing)	Connector 2 (Lifeline)
70007951729	3101639-75	2.4m Webbing Lifeline	Single	LE direct connect	R-113
70007940938	3101641-75	2.4m Webbing Lifeline	Twin	LE direct connect	R-113
70007446910	3101640	2.4m Webbing Lifeline	Twin	LE direct connect	2000209
70007456471	3500255	2.4m Cable Lifeline	Twin	LE direct connect	2000209



### 3M™ DBI-SALA® Nano-Lok™ 2G Self-Retracting Lifelines

3M Order Code	Model #	Description	Single-Leg/Twin-Leg	Connector 1 (Housing)	Connector 2 (Lifeline)
70007455226	3101330	1.8m Webbing Lifeline	Single	Direct Connect	9502116
70007444188	3101331	1.8m Webbing Lifeline	Single	Direct Connect	9502058
70007455234	3101339	1.8m Webbing Lifeline	Single	R-113	R-113
70007931119	3101340	1.8m Webbing Lifeline	Single	R-119	R-119
70007931986	3101342	1.8m Webbing Lifeline	Single	R-113	2109193
70804501743	3101709	1.8m Webbing Lifeline	Single	2000184	2000214
70007455242	3101345	1.8m Webbing Lifeline	Twin	Direct Connect	2100193
70007444246	3101346	1.8m Webbing Lifeline	Twin	Direct Connect	9502058
70804506031	3101718	1.8m Webbing Lifeline	Twin	Direct Connect	2000214
70804506049	3101719	1.8m Webbing Lifeline	Twin	Direct Connect	2000209

# Connectors



3101594



3101615



3101366

## 3M™ DBI-SALA® Nano-Lok™ Tie-Back Self Retracting Lifelines

3M Order Code	Model #	Description	Single-Leg/Twin-Leg	Connector 1 (Housing)	Connector 2 (Lifeline)
70007444295	3101366	2.7m Webbing Lifeline	Single	Direct Connect	9501804

## 3M™ DBI-SALA® Nano-Lok™ XL Self Retracting Lifelines

3M Order Code	Model #	Description	Single-Leg/Twin-Leg	Connector 1 (Housing)	Connector 2 (Lifeline)
70007456174	3101615	Single 3.4m Webbing Lifeline	Single	3100064	9502116
70007456117	3101594	Single 2.8m Webbing Lifeline	Single	2000112	2109193



3101521



3101524



3101523

## 3M™ DBI-SALA® Nano-Lok™ Hot Work Self Retracting Lifelines

3M Order Code	Model #	Description	Single-Leg/Twin-Leg	Connector 1 (Housing)	Connector 2 (Lifeline)
70007445672	3101521	1.8m Nomex®/Kevlar® Fibre Webbing Lifeline	Single	3100127	2109193
70007445680	3101523	1.8m Nomex®/Kevlar® Fibre Webbing Lifeline	Single	2000112	9502116
70007455838	3101524	1.8m Nomex®/Kevlar® Fibre Webbing Lifelines	Twin	3100109	2109193



## 3M™ DBI-SALA™ Smart Lock Self-Retracting Lifelines

- **Swivelling anchorage & Karabiner included**
- **Ergonomic handle.**  
Designed for easy transport and support during overhead installation.
- **Magnetic retraction control.**  
The lifeline rewinds at an evenly controlled pace, helping reduce the possibility for harm to people or equipment (compared to solutions with gear based retraction).
- **Patent pending dual label system.**  
An extra label stored in the bumper on the lifeline allows users to easily access critical asset information and keeps it protected from damage to help reduce cost of ownership.
- **Highly-visible orange energy-absorber cover.**  
Identifies product as meeting Leading Edge standards and allows you to more easily confirm that workers are tied off (Horizontal models).
- **6kN Maximum Arresting Force (MAF)**
- **190kg weight capacity**



## 3M™ DBI-SALA® Sealed-Blok™ Self-Retracting Lifeline

When grease, dirt and moisture are just part of your job. Keeping them from affecting the performance of your SRL is ours. These sealed SRLs are constructed from heavy-duty, corrosion-resistant materials, and incorporate a patented concept that separates all dynamic components—including the motor spring and brake—from foreign elements.

### Carrying handle

- Built-in design for easy transport—certified as secondary 3101001 fall arrest rated anchorage point.

### Galvanised & stainless steel cable

- Abrasion resistant and corrosion-resistant lifeline options.

### Self-locking swivel hook

- Limits lifeline twisting
- Integrated impact indicator
- 16kN gate reduces accidental disengagements (“roll-out”)

### Fast Line

- Provides the user with ability to replace the lifeline in the field.



## 3M™ DBI-SALA® Ultra-Lok™ Self-Retracting Lifelines

Rugged durability. Extremely lightweight. These SRLs are engineered to deliver everything you need to maximize your safety, efficiency and comfort. Stainless steel components, an antiratcheting brake system and a semi-sealed design result in a system that's truly built to last.

### Top swivel

- Limits lifeline twisting for smoother operation.

### Thermoplastic housing

- Lightweight, compact and durable.

### Ergonomic cable handle

- Provides added comfort and ease-of-use when making connections.

### Multiple lifeline options

- Galvanized or stainless steel cable

### Self-locking swivel hook

- Limits lifeline twisting
- Integrated impact indicator
- 16kN gate reduces accidental disengagements (“roll-out”)



## 3M™ DBI-SALA® Nano-Lok™ Extended Length Self-Retracting Lifelines (SRL's), 6 m (Overhead)

### Swivelling Anchorage Loop

- Limits lifeline twisting for smooth operation.

### Impact-Resistant Housing

- Tough thermoplastic housing designed to withstand demanding worksites.

### Speed-Sensing Brake System

- Reduces fall clearance

### Dyneema® Fibre and Polyester Web Lifeline

- Synthetic lifeline reduces overall weight and the retractable design provides freedom of movement.

### High-Capacity External Energy Absorber

- Maintains safe fall arrest forces for users up to 140 kg.

### Impact Indicator

- Energy Absorber deployment provides a visual alert that the SRL has been involved in a fall

	Swivel Steel Snap Hook	Swivel Steel Snap Hook	Swivel Stainless Steel Snap Hook	Swivel Stainless Steel Snap Hook	Swivel Steel Snap Hook
Gate Opening	19mm	19mm	57mm	57mm	19mm
Gate Strength	16kN	16kN	16kN	16kN	16kN
Model #	9502194	2000180	2000181	2100044	9502195

# Connectors

## 3M™ DBI-SALA™ Smart Lock Self-Retracting Lifelines

3M Order Code	Model #	Description	Lifeline Connector
70804492539	3503803	6m Galvanised Steel Wire Rope	9502194
70804492547	3503804	6m Stainless Steel Wire Rope	2100044



## 3M™ DBI-SALA® Smart Lock™ LE Self Retracting Lifelines

3M Order Code	Model #	Description	Lifeline Connector
70804492521	3503802	6m Galvanised Steel Wire Rope with EZ-Stop energy absorber	9502194
70804492588	3503822	9m Galvanised Steel Wire Rope with EZ-Stop energy absorber	9502194

## 3M™ DBI-SALA® Sealed-Blok™ Self-Retracting Lifeline

3M Order Code	Model #	Description	Lifeline Connector	Fast Line
70007459533	3400803	9m Galvanised Steel Wire Rope	2000180	✓
70007450631	3400805	9m Stainless Steel Wire Rope	2000181	✓
70007460077	3400950	15m Galvanised Wire Rope	2000180	✓
70007460085	3400951	15m Stainless Steel Wire Rope	2000181	✓
70007459772	3400866	25m Galvanised Wire Rope	2000180	✓
70007459780	3400867	25m Stainless Steel Wire Rope	2000181	✓
70007452074	3400971	40m Galvanised Wire Rope	2000180	✓
70007452082	3400972	40m Stainless Steel Wire Rope	2000180	✓

## 3M™ DBI-SALA® Ultra-Lok™ Self Retracting Lifelines

3M Order Code	Model #	Description	Lifeline Connector
70007462974	3504427	6m Galvanised Wire Rope	9502194
70007456562	3504424	9m Galvanised Wire Rope	9502194
70007456844	3504465	15m Galvanised Wire Rope	9502194
70007463196	3504489	26m Galvanised Wire Rope	9502194

## 3M™ DBI-SALA® Nano-Lok™ Extended Length Self-Retracting Lifelines 6 m

3M Order Code	Model #	Description	Connector 1 (Housing)	Connector 2 (Housing)
70804498130	3103867	6m Dyneema and Polyester Web	2000112	9502195

## 3M™ DBI-SALA® Karabiners

3M Order Code	Model #	Description	Gate Strength	Gate Opening
AT019422370	8700130	Steel Double Action, Autolock with captive eye	16kN	20mm
70007928651	2000114	Steel Double Action, Autolock with captive eye	16kN	55.5mm
70007926986	R-113	Steel Triple Action, Autolock with captive eye	16kN	20mm
70007930558	R-119	Stainless Steel Triple Action, Autolock with captive eye	16kN	20mm
70007449807	2000300	Steel Triple Action, Autolock with captive eye	16kN	51mm



\*Additional connector combinations available.

## 3M DBI-SALA Lad-Saf™ Vertical Cable Systems

### 3M™ DBI-SALA® Lad-Saf Top & Bottom Bracket Kits

3M Order Code	Model #	Description	Users
70804503277	6116631	Galvanised Steel, level with top, to suit Ladder Rung	2
70804503285	6116632	Stainless Steel, level with top, to suit Ladder Rung	2
70804503293	6116633	Galvanised Steel, level with top, to suit Ladder Rung	4
70804503301	6116634	Galvanised Steel to suit Mono Pole	4
70804503327	6116636	Galvanised Steel, climb extension, to suit Ladder Rung	2
70804503343	6116638	Stainless Steel to suit Mono Pole	4



### 3M™ DBI-SALA® Lad-Saf™ Pre-Swage Cable 7×19, 9.5mm Diameter

#### Galvanised

3M Order Code	Model #	Metres
AT010622143	6115001	3m
AT010622150	6115002	6m
AT010622168	6115003	9m
AT010622176	6115004	12m
AT010622184	6115005	15m
AT010622192	6115006	20m
AT010643495	6115018	25m
AT010622200	6115007	30m
AT010643503	6115019	35m
AT010622218	6115008	40m
AT010643511	6115020	45m
AT010622226	6115009	50m
AT010643529	6115021	55m
AT010622234	6115010	60m
AT010643537	6115022	65m
AT010643552	6115024	80m
AT010622143	6115001	80m

#### Stainless Steel

3M Order Code	Model #	Metres
AT010622242	6115011	3m
AT010622259	6115012	6m
AT010622267	6115013	9m
AT010622283	6115015	15m
AT010622291	6115016	20m
AT010643636	6115032	25m
AT010622309	6115017	30m
AT010643644	6115033	35m
AT010643669	6115035	45m
AT010644105	6115042	90m



6115001



6100400



6100457

### 3M™ DBI-SALA® Lad-Saf™ Cable Guides

3M Order Code	Model #	Description	Application
70007475786	6100400	Galvanised Assembly to suit <1-1/8" Rung, Straight	Standard
70007470415	6100457	Stainless Steel Assembly to suit <1" Rung, Straight	Standard
70804505751	6100513	Stainless Steel Assembly to suit <1-5/8" Rung, 90 degree	Standard
70007470464	6100515	Galvanised Assembly to suit 5-3/4" in length, 90 degree	Monopole
70007934675	LS379	Galvanised, Straight	Monopole
70007475851	LS379-ASS	Galvanised Assembly, Straight	Monopole

### 3M™ DBI-SALA® Lad-Saf™ X3+ Sleeve

3M Order Code	Model #	Description
70007484242	6160052	Detachable Cable Sleeve with Zinc Plated Steel Double Action Karabiner
AT019424947	6160065	Detachable Cable Sleeve with Zinc Plated Steel Triple Action Karabiner



6160052

**Certified Lad Saf training available.  
Contact your local 3M Fall Protection expert for more information.**

## 3M™ Protecta® Shock Absorbing Lanyards



### 3M™ PROTECTA® Shock Absorbing Webbing Lanyards



3M Order Code	Model #	Description	Single-Leg/ Twin-Leg	Connector 1 (Harness)	Connector 2 (Anchor)
70007925442	AE529/3AU	Non-adjustable, 2.0m with snap hooks on all connections	Single	2000161	2000161
70007927414	AE529/13AU	Non-adjustable, 1.5m with snap hooks on all connections	Single	2000161	2000161
70007940599	AE529E/3AU	Elasticated, 2.0m with snap hooks on all connections	Single	2000161	2000161
70007928537	AE529ADJ/3AU	Adjustable from 0.75 - 2.0m with snap hooks on all connections	Single	2000161	2000161
70007940284	AE529ADJ/5AU	Adjustable from 0.75 - 2.0m with snap hook and scaffold hooks	Twin	2000161	2000164
70007926879	AE529EY/5AU	Elasticated, 2.0m with snap hook and scaffold hooks	Twin	2000161	2000164

### 3M™ PROTECTA® Shock Absorbing Welders Lanyards



3M Order Code	Model #	Description	Single-Leg/ Twin-Leg	Connector 1 (Harness)	Connector 2 (Anchor)
70007944229	AE529/3W	Non-adjustable, 2.0m with snap hooks on all connections	Single	2000161	2000161
70007942900	AE529/5W	Non-adjustable, 2.0m with snap hook and scaffold hook	Single	2000161	2000164
70007948808	AE529/9W	Non-adjustable, 2.0m with triple action karabiners on all connections	Single	R-113	R-113

### 3M™ PROTECTA® Shock Absorbing Rope Lanyards



3M Order Code	Model #	Description	Single-Leg/ Twin-Leg	Connector 1 (Harness)	Connector 2 (Anchor)
70007942074	AE529ADJ/9R	Adjustable from 0.75 - 2.0m with steel triple action karabiners on all connections	Single	R-113	R-113
AT010644832	AE529ADJ/10R	Adjustable from 0.75 - 2.0m with steel triple action karabiner and scaffold hook	Single	R-113	2000164
AT010644840	AE529ADJY/10R	Adjustable from 0.75 - 2.0m with steel triple action karabiner and scaffold hooks	Twin	R-113	2000164
AT010783069	AE529ADJ/8R	Adjustable from 0.75 - 2.0m with stainless steel triple action karabiners on all connections	Single	R-119	R-119

### 3M™ PROTECTA® P50 Shock Absorbing Webbing Lanyards

3M Order Code	Model #	Description	Single-Leg/ Twin-Leg	Connector 1 (Harness)	Connector 2 (Anchor)
AT010621624	1390066A	Adjustable from 0.75 - 2.0m with snap hooks on all connections	Single	2000161	2000161
AT010621616	1390065A	Non-adjustable, 2.0m with snap hook and scaffold hooks	Twin	2000161	2000164

### 3M™ PROTECTA® Lifelines

3M™ PROTECTA® 11mm Kernmantle rope lifeline with sewn thimble eye, fitted with connector at one end and sewn end stop on the other, rope adjuster.



3M™ PROTECTA® 11mm Kernmantle rope lifeline with sewn thimble eye, fitted with connector at one end and sewn end stop on the other, rope adjuster with shock absorber fitted with connector.



3M Order Code	Model #	Length	Connector
70007929683	AC415MAU	15m	R-105-S-CE
70007947289	AC420MAU	20m	R-105-S-CE
70007934667	AC430MAU	30m	R-105-S-CE

3M Order Code	Model #	Length	Connector
70007928495	AC415MBAU	15m	R-105-S-CE
70007939401	AC420MBAU	20m	R-105-S-CE
70007944278	AC430MBAU	30m	R-105-S-CE

\* All twin tail lanyards are supplied with E839 lanyard stowage points. If a dorsal extension is part of your harness the maximum lanyard assembly permitted is 1.7m or less

\* Viper™ 2 Rope Grabs must only be used with 3M supplied Viper™ 10.5mm Kernmantle Rope. Cobra™ Rope Grabs must only be used with 3M supplied Cobra™ 14-16mm 3-Strand Rope

## Connectors

# 3M™ Protecta® Viper™ & Cobra™ Lifelines



AC400



AC202/01



AC202/02



AC215



5009137

### 3M™ PROTECTA® Viper™ Lifelines

10.5mm Kernmantle rope lifeline with sewn thimbled eye, fitted with connector at one end and knotted end stop on the other.

3M Order Code	Model #	Length	Connector
70804885682	5009137	20m	2000117
70007910337	AC440	40m	AJ501/0
70007914776	AC460	60m	AJ501/0

### 3M™ PROTECTA® Cobra™ Lifelines

14-16mm 3-Strand rope vertical lifeline with sewn thimbled eye, fitted with connector at one end and knotted end stop on the other.

3M Order Code	Model #	Length	Connector
70007909313	AC215	15m	AJ501/0
70007902938	AC230	30m	AJ501/0
70007904066	AC260	60m	AJ501/0

### 3M™ PROTECTA® Rope Grabs

3M Order Code	Model #	Description
70007781688	AC400	Viper™ 2 Rope Grab with Karabiner to suit 10.5mm Kernmantle Rope
70007902615	AC202/01	Cobra™ Automatic Rope Grab with Karabiner to suit 14-16mm 3-Strand Rope
70007907408	AC202/02	Cobra™ Automatic Rope Grab integral shock pack and snap hook to suit 14-16mm 3-Strand Rope

### 3M™ PROTECTA® Rebel™ Personal Self Retracting Lifelines

3M Order Code	Model #	Description	Single-Leg/ Twin-Leg	Connector 1 (Harness)	Connector 2 (Anchor)
70007443099	3100445	1.8m Webbing Lifeline	Single-Leg	2000192	2000161
70007454393	3100447	3.3m Webbing Lifeline	Single-Leg		2000161
70007454401	3100448	6.0m Webbing Lifeline	Single-Leg		2000161

### 3M™ PROTECTA® Rebel™ Self Retracting Lifelines

3M Order Code	Model #	Description	Lifeline Connector
70007458675	3590520	6m Galvanised Steel Wire Rope	2000175
70007464996	3590521	10m Galvanised Steel Wire Rope	2000175
70007460440	3590570	15m Galvanised Steel Wire Rope	2000175
70007460549	3590610	20m Galvanised Steel Wire Rope	2000175
70007460622	3590690	30m Galvanised Steel Wire Rope	2000175
70007460382	3590536	10m Stainless Steel Wire Rope	2000126
70007466082	3590609	20m Stainless Steel Wire Rope	2000126



### 3M™ PROTECTA® Rebel™ Leading Edge Self Retracting Lifelines

3M Order Code	Model #	Description	Lifeline Connector
70007465076	3590540	6m Stainless Steel Wire Rope	2000178
70007460408	3590546	15m Stainless Steel Wire Rope	2000178
70007465944	3590548	20m Stainless Steel Wire Rope	2000178

### 3M™ PROTECTA® Rebel™ Self Retracting Lifelines with Triple Action Karabiner

3M Order Code	Model #	Description	Lifeline Connector
70007460382	3590536	10m Galvanised Steel Wire Rope	2000126
70007466082	3590609	20m Galvanised Steel Wire Rope	2000126





# Descent & Rescue

Thanks to 3M, not only keeping the worker safe, but getting him safely back on terra firma has never been easier with our rescue equipment. We offer the most complete line of safe and effective rescue systems in the industry, trusted by safety professionals and workers globally.

# 3M™ DBI-SALA® High Capacity Davit

Designed for manhole and confined space entry/retrieval applications. The Davit pivots for ease of rescue and has an adjustment for overhead clearance restrictions. The lower base adjusts to fit most standard entries. A range of bases and masts are available.

### Features and Benefits:

#### Fall Arrest Anchorage

Davits offer 4 x AS/NSZ 5532 type B anchor points

- 2 anchor points for direct connection with fall arrest PPE
- 2 guided cable lifelines from a 3M™ mounted SRL.

#### One Front and One Back Cable Lifeline Guide

In addition to being a fall arrest anchorage, the 2 guided cable lifelines serve as:

- Rescue line with a mounted 3M™ DBI-SALA® rescue winch or 3M™ SRL with built-in rescue winch
- Raising / lowering line for people or load with a mounted 3M™ DBI-SALA® man and load-riding digital winch.

#### Winch and SRL Options

- Winch and SRL can be mounted on the mast with appropriate bracket.
- **Front or back mounting choice is possible to allow the most convenient positioning for the user**, unlike some others systems that only allow the winch and SRL to be back mounted or allowing only one fixation to the mast.

#### Adjustable Reach and Height

- Selection of one of the 4 davit mast extension options allows the user to select the best height setting for the operating environment.
- Multiple pins position of the gusset arm and head allows the user to adjust the best reach and height needed for the application.
- Possibility of maximum height of anchorage point is 2.91 m, allowing use over most tanks edges and guardrails.

#### Base Options

- Fixed bases in galvanized steel or stainless steel are available to accommodate a variety of anchorage locations.
- One short reach and one long reach portable 3 piece base options allow full versatility of the systems.
- Maximum external width of long reach 3 piece base is 2.61 m, allowing the surround of very large confined space openings.



Winch and SRL sold separately



# Descent & Rescue

## High Capacity 5 Piece Davit Systems

3M Order Code	Model #	Description	Length	Width	Height
70804508425	8000132	Short Reach	140cm	121.3-190cm	204.2-254.2cm
70804508433	8000133	Long Reach	182.9cm	192.7-261cm	222.3-280.5cm

## High Capacity Davit Arms

3M Order Code	Model #	Description	Reach	Height
70804508409	8000130	Short Reach Upper Mast Assembly	36-71cm	93-96.5cm
70804508417	8000131	Long Reach Upper Mast Assembly	68.9-111.9cm	120.9-133.5cm
70804507856	8000128	Short Reach Offset Arm	36-71cm	N/A
70804507864	8000129	Long Reach Offset Arm	68.9-111.9cm	N/A
70804503509	8000109	Universal Lower Mast Assembly (to suit 8000128 & 8000129)	N/A	TBA

## High Capacity Davit Mast Extension

3M Order Code	Model #	Length
70804503533	8000112	53.3cm
70804503541	8000113	83.8cm
70804503558	8000114	114.3cm
70804503566	8000115	144.8cm

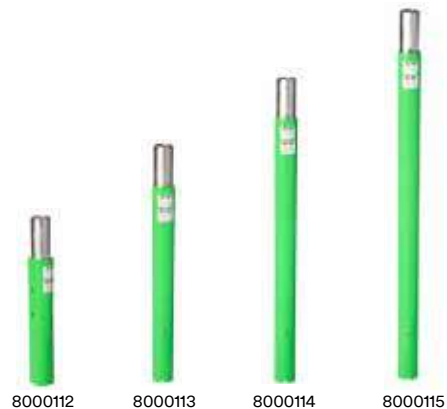

## High Capacity Portable Davit Bases

3M Order Code	Model #	Description	Length	Width
70804502295	8000104	3 Piece Short Reach	140cm	121.3-190cm
70804502303	8000105	3 Piece Long Reach	182.9cm	192.7-261cm
70804503178	8000106	Counterweight with Cart	223.5-299.7cm	239cm
70804501883	8000103	Vehicle Hitch Mount	188.4-264.6cm	239cm



8000101



8000091



8000089



8000095



8000099

## High Capacity Davit Bases

3M Order Code	Model #	Description	Material
70804498841	8000101	Wall Mount	Galvanised Steel
70804498858	8000102	Wall Mount	Stainless Steel
70804498726	8000089	Flush Core Mount	Galvanised Steel
70804498734	8000090	Flush Core Mount	Stainless Steel
70804498742	8000091	Flush Core Mount with Top Plate	Galvanised Steel
70804498759	8000092	Flush Core Mount with Top Plate	Stainless Steel
70804498783	8000095	Floor Mount	Galvanised Steel
70804498791	8000096	Floor Mount	Stainless Steel
70804498825	8000099	Deck Mount	Galvanised Steel
70804498833	8000100	Deck Mount	Stainless Steel

## Descent & Rescue

# 3M™ DBI-SALA® Tripods

Constructed of lightweight tubular aluminum with a rugged steel head assembly. Quick-release pins positively locate components at all adjustment points for tool-free setup and adjustment.

### Features and Benefits:

#### Mechanical Devices

Supports up to three winches or SRLs for complete flexibility.

#### Quick-Connect Bracket

Fast and easy attachment of mechanical devices.

#### Safety Chain

Added support in demanding applications.

#### Top Mounted Pulley System

Mount up to three pulleys to route mechanical device lifelines.

#### Secondary Anchor Point

22 kN anchor point for secondary fall arrest system.

#### Aluminum Construction

Lightweight and durable for ease-of-use.



### Aluminium Tripod

3M Order Code	Model #	Height		Spread of Legs (Inside Shoe)		Storage Height
		Minimum	Maximum	Minimum	Maximum	
70007488417	8000000	172.7cm	236.2cm	111.8cm	160cm	177.8cm
70007490959	8000010	242.3cm	304.8cm	165.1cm	203.4	259cm



8003205



8003238



9503094

8005048

### Aluminium Tripod Accessories

3M Order Code	Model #	Description
70007612537	9503094	Tripod Carry Bag to suit 8000000
70007612545	9503095	Tripod Carry Bag to suit 8000010
70007488649	8003205	Snatch Block Pulley Assembly for use with Tripod Eye Bolt
70007488656	8003238	Leg Mount Pulley Bracket for Tripod Leg
70007489506	8005048	Mounting Bracket to fit SRL/Winch to Tripod Leg

## 3M™ DBI-SALA® Advanced Digital Winches



### 100 Series 2 Speed 4:1 & 9:1

3M Order Code	Model #	Description	Removable Handle	Power Drive
70007496816	8518560	18m, 5mm Galvanised Cable	✓	
70007496808	8518558	18m, 5mm Stainless Steel Cable	✓	
70007496824	8518561	27m, 5mm Galvanised Cable	✓	
70007496568	8518566	27m, 5mm Stainless Steel Cable	✓	✓
70007496840	8518568	27m, 5mm Galvanised Cable	✓	✓

### 200 Series 2 Speed 4:1 & 9:1

3M Order Code	Model #	Description	Removable Handle	Power Drive
70007496857	8518579	42m, 5mm Stainless Steel Cable	✓	
70007498184	8518582	58m, 5mm Galvanised Cable	✓	
70007498192	8518586	58m, 5mm Stainless Steel Cable	✓	✓
70007498200	8518587	58m, 5mm Stainless Steel Cable	✓	✓

### 300 Series 2 Speed 4:1 & 9:1

3M Order Code	Model #	Description	Removable Handle	Power Drive
70007498259	8518609	88m, 5mm Stainless Steel Cable	✓	✓

### 3M™ DBI-SALA® Salalift™ II Winch

3M Order Code	Model #	Description
70007489712	8102001	18m, 6mm Galvanised Cable
70007491478	8102003	18m, 6mm Stainless Steel
70007489746	8102009	27m, 5mm Galvanised Cable
70007491486	8102011	27m, 5mm Stainless Steel Cable
70007489720	8102005	36m, 5mm Galvanised Cable



### 3M™ DBI-SALA® Winch Brackets & Accessories

3M Order Code	Model #	Description
70007928396	8510207	Winch/SRL Adapter with Flat Back to attach DBI-SALA Winch to structures
70007494225	8512936	Overload Protection Clutch, working load of 204kg
70007495669	8517567	Padded Carry Bag

Other winch lengths available on request

## 3M™ DBI-SALA® Emergency Retrieval Sealed-Blok SRL's

Sealed design makes it ideal for working in even the harshest of environments. All Emergency Retrieval Sealed-Blok Self Retracting Lifelines feature an ergonomic integral carrying handle and anchorage karabiner.

Fastline feature provides the user with ability to replace the lifeline in the field.



3M Order Code	Model #	Description	Lifeline Connector	Fastline
70007460093	3400955	15m, 5mm Galvanised Cable	2000180	✓
70007452025	3400956	15m, 5mm Stainless Steel Cable	2000181	✓
70007451720	3400880	25m, 5mm Galvanised Cable	2000180	✓
70007459830	3400881	25m, 5mm Stainless Steel Cable	2000181	✓
70007460168	3400985	40m, 5mm Galvanised Cable	2000180	✓
70007452157	3400986	40m, 5mm Stainless Steel Cable	2000180	✓
70804516899	3400897	25m, 5mm Galvanised Cable	2000126	✓
70804516907	3400898	25m, 5mm Stainless Steel Cable	2000126	✓
70804516915	3400957	15m, 5mm Galvanised Cable	2000126	✓
70804516923	3400958	15m, 5mm Stainless Steel Cable	2000126	✓
70804516931	3400998	40m, 5mm Galvanised Cable	2000126	✓
70804516949	3400999	40m, 5mm Stainless Steel Cable	2000126	✓

\*triple action versions available on request

### 3M™ DBI-SALA® Emergency Retrieval Sealed-Blok SRL's RSQ

3M Order Code	Model #	Description	Lifeline Connector	Fastline
70007460069	3400944	15m, 5mm Stainless Steel Cable	2000181	✓

### 3M™ DBI-SALA® Emergency Retrieval Sealed-Blok SRL's Accessories

3M Order Code	Model #	Description
70007452256	3401025	Mounting Bracket



### 3M™ DBI-SALA® Ultra-Lok™ RSQ

Inbuilt dual mode rescue system for assisted rescue utilising the First-Man-Up™ Pole or automatic rescue mode for Self Rescue/Descent.

3M Order Code	Model #	Description	Lifeline Connector
70007463279	3504555	15m, 5mm Stainless Steel Cable	2100044
70007453874	3500102	First-Man-Up™ Pole with assisted rescue tool 2.4 - 4.8m	N/A

## 3M™ DBI-SALA® Portable Fall Arrest System

### Portable Fall Arrest System

- Three independent swiveling tie-off points.
- 360 degrees of protection for three workers.
- Telescopic design;
- 83.2 cm–116.8 cm–145.4 cm
- Lightweight and durable aluminum construction.

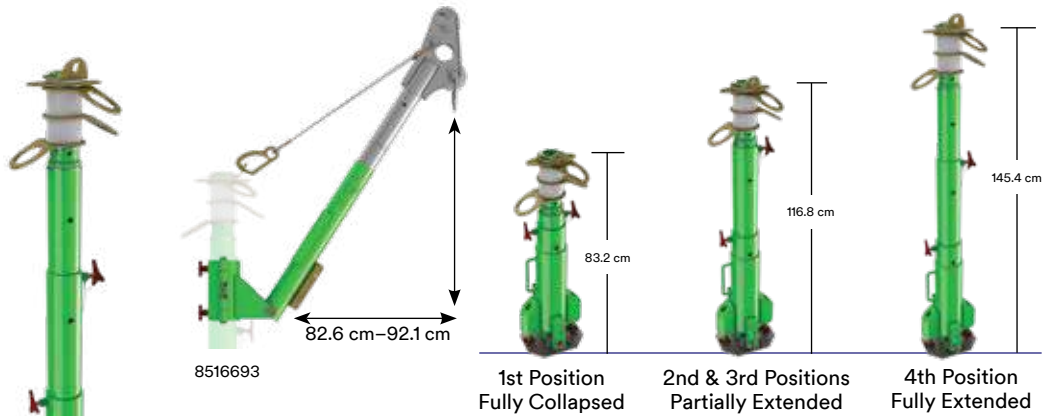

### Rescue Davit Arm for Portable Fall Arrest Post

The optional rescue davit arm assembles easily to our portable fall arrest post, providing simple and efficient rescue and material handling capabilities.

8516691

3M Order Code	Model #	Description
70007495354	8516691	Advanced Portable Fall Arrest Post
70007495370	8516693	Rescue Davit Arm for Portable Fall Arrest Post

### Portable Fall Arrest System Bases & Accessories

3M Order Code	Model #	Description
70007495594	8517412	Bare Steel Uni-Anchor with Tie Off Anchor
70007491965	8510816	Weld on Mounting Plate, unplated mild steel construction
	8517413	Incline Adapter with Tie-Off Anchor
	8519819	Base Concrete Anchor
70007495362	8516692	355.6mm Extension Post to suit 8516691
70007496048	8517565	Heavy-duty carry bag to suit 8516691 or 8516693



### 3M™ DBI-SALA® Side Entry Systems

3M Order Code	Model #	Description
70007493102	8511233	Side entry system package for use with external adjustment tank collar
70007493094	8516693	Permanently mounted bases External adjustable tank collar



### 3M™ DBI-SALA® Pole Hoist System

3M Order Code	Model #	Description
70007492930	8510409	1499-1956mm Extendable Pole Hoist, swivel head and hardware, includes winch bracket
70007492971	8510476	1829-3048mm Extendable Pole Hoist, swivel head and hardware, includes winch bracket
70007493128	8511235	T-Bar Leg Assembly to suit Extendable Pole Hoist
70007452405	2104550	Steel Anchor Plate with D-Ring to suit 3/8 to 1" plate steel

## 3M™ DBI-SALA® Self-Rescue Device

Work at height without worrying about hanging in your harness for an extended period of time after an arrested fall event. Instead of waiting for help, lower yourself to safety with the 3M™ DBI-SALA® Self-Rescue Device.

### Features and Benefits:

- **Easily Accessible Primary Release Cord**
- **Easy-Link SRL Adapter**  
A simple, fast connection point for your lanyards or personal SRLs.
- **Moulded Padding**  
Protects the bag from wear and tear.
- **Colour-Coded and Reflective Elements**  
Provides greater visibility, even in dark situations.
- **Assisted-Rescue and 3M™ DBI-SALA® Rescue Pole**  
Allows for remote access and deployment by a colleague.
- **15m-30m Lengths**  
More flexibility and freedom to work at height worry-free.
- **7m Training Version**



3320030



20.3 cm

### Rescue Pole

Kit includes bag, rescue pole, carabiner and tagline.

Bag length: 72.4cm

Width: 15.2cm.

Depth: 5.8cm

Weight: 0.907kg

Pole extends to 264cm.



8900299



48.3 cm

6.3 cm

Lightweight, low profile design minimizes impact on user's motion.

3M Order Code	Model #	Description
70007650362	3320030	Self-Rescue Device 15m
70007650370	3320031	Self-Rescue Device 30m
70007649497	3320037	Self-Rescue Training Device 7m
70007650040	8900299	Rescue Pole with Bag



# 3M™ DBI-SALA® Rollgliss™ R550 Rescue and Descent

Keep rescues simple with one of the lightest, most compact and easy-to-use devices in the industry.

- 1 Drill Adapter**  
Provides a mechanical option to raise a victim.
- 2 Cast Aluminum Housing**  
Lightweight and extremely durable.
- 3 Bi-Directional Hub**  
Brings one hook up as the other goes down, for immediate use after each descent.
- 4 Anchorage**  
Provides greater visibility, even in dark situations.
- 5 Integrated Rope Ears**  
Greater descent speed control in assisted rescues.
- 6 Dual Brakes**  
Added security, safety and peace of mind.
- 7 Durable Rope**  
9.5 mm Static Kernmantle Rope.
- 8 Lifeline Hook**  
Patented Self-Locking Snap Hook.



Drill adapter



Super-tough nylon makes the rescue wheel lightweight and durable. The ergonomic design provides a better grip and more control.



### Multiple Length Options

Lengths between 10 and 150m

### Two-Person Capacity

Can be used from heights up to 500 m for one user at 141 kg or 175 m for two users totalling 282 kg

# Always be rescue – ready

Be ready for at-height rescues with the 3M™ DBI-SALA® R550 Rescue System

## 3M™ DBI-SALA® R550 Rescue Units

3M Order Code	Model #	Length
70007945366	3329010	10m
70007926663	3329020	20m
70007940706	3329040	40m
70007939146	3329060	60m
70007934568	3329080	80m
70007928107	3329100	100m
70008283106	3329150	150m

## 3M™ DBI-SALA® R550 Remote Rescue Kit with Rescue Hook & Telescopic Pick Pole

3M Order Code	Model #	Length
70007941308	1907-0010	10m
70007929667	1907-0020	20m
70007944039	1907-0030	30m
70007938387	1907-0040	40m
70008281720	1907-0050	50m
70008280425	1907-0060	60m
AT010643487	1907-0070	70m
70007937322	1907-0100	100m
70007950507	1907-0150	150m

## 3M™ DBI-SALA® R550 Escape Units

3M Order Code	Model #	Length
70007931325	3328010	10m
70008282991	3328020	20m
AT019424269	3328030	30m
70007940888	3328040	40m
70008283007	3328060	60m
70008283015	3328100	100m
70007962650	3328120	120m



## R550 Rescue Kit Bag

3M Order Code	Model #
70804512245	9514746



## Micro Pulley

3M Order Code	Model #
70804512591	9514753

## Cable Grab

3M Order Code	Model #
70804512237	5000028

## Web Strap Angled Descent

3M Order Code	Model #
70007668604	1200207

## Heavy Duty Telescopic Pole with Bag

3M Order Code	Model #
70007926853	8900031



## RA Edge Protector - Gen 2

3M Order Code	Model #
70804512401	3320046



## Web Grab

3M Order Code	Model #
70804514274	5000032



## Ladder Bracket

3M Order Code	Model #
70007458683	3320014



## Humidity Case

3M Order Code	Model #
70007627741	9508289



## Scaffold Hook

3M Order Code	Model #
70007781860	AJ527



## R550 Rescue Kit

3M Order Code	Model #
70804512252	3300005



# Descent & Rescue

## 3M™ DBI-SALA® Rescue Positioning Device Kit

Simple yet extremely reliable rescue or positioning system designed to raise and/or lower yourself or someone else, providing a stable way to reach a working level, even in tight space.



3M Order Code	Model #	Length	M/A
70007931010	3600050	15m System	3:1
70007944161	3600075	23m System	3:1
70007930582	3600100	30m System	3:1
70007939328	3602050	15m System	4:1
70007955449	3602075	23m System	4:1
70007959110	3602100	30m System	4:1

## 3M™ DBI-SALA® Rollgliss™ R350 Rescue System

All R350 kits include: rope unit, pulleys, rope control device with integral lanyard, anchor strap, karabiners and carry bag.



3M Order Code	Model #	Length	M/A
70007942710	R3503015	15 m system	3:1
70007947776	R3503030	30 m system	3:1
70007946778	R3503030P	30 m system, with pick pole	3:1

## 3M™ DBI-SALA® Self Rescue Descender System (SRD)

All SRD kits include: descender, kernmantle rope, karabiner (SRD1 series), hammerlok with snap hook (SRD2 series), U bolt, storage/ deployment box, tracer wire with R-clip, spacer and certification tag.

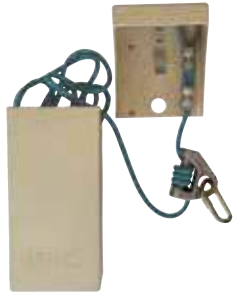

3M Order Code	Model #	Description
70007942017	SRD1-20	20 m system, SRD1 series <b>Also available:</b> 25 m and 30 m systems
70007958757	SRD2-20	20 m system, SRD2 series <b>Also available:</b> 25 m and 30 m systems

## 3M™ DBI-Sala® RescueMate™ Auto Lock Haul Kits

3M Order Code	Model #	Length	M/A
70007931309	8704103	5m	4:1
70007933347	8704104	10m	4:1
70007930392	8704105	15m	4:1
70007952271	8704106	20m	4:1
70007928206	8705104	10m	6:1
70007935151	8705105	14m	6:1
70007934246	8705106	20m	6:1
70007946497	8705110	40m	6:1



8705104

## 3M™ DBI-SALA® Trigger X Adjustable Positioning Rope System

3M Order Code	Model #	Length	Tie-Back	Mode		Rope Line Connector
				Single	Double	
70804491408	1234084	2.4m	✓	✓		Steel Scaffold Hook
70804491416	1234085	2.4m		✓		Aluminium Scaffold Hook
70804491424	1234086	2.4m		✓	✓	Aluminium Snap Hook
70804491432	1234087	3m		✓		Aluminium Scaffold Hook
70804491440	1234088	3m	✓	✓		Steel Scaffold Hook
70804493966	1234089	3m		✓	✓	Aluminium Snap Hook
70804493974	1234090	1.8m		✓		Aluminium Scaffold Hook
70804493982	1234091	1.8m		✓	✓	Aluminium Snap Hook
70804493990	1234092	1.8m	✓	✓		Steel Scaffold Hook



M/A = Mechanical Advantage

# Descent & Rescue



8700198



2000025



8700200



2000117



2000172

## 3M™ DBI-SALA® Rollgliss® Karabiners

3M Order Code	Model #	Description	Gate Strength	Gate Opening
70007931721	8700200	Small Offset D, Aluminium triple action autolock	9kN	18mm
70007925079	2000117	Medium Offset D, Stainless Steel double action autolock	16kN	20mm
70007930228	8700198	Medium Offset D, Aluminium screw gate	8kN	22mm
70007934030	2000172	Large Offset D, Stainless Steel triple action autolock	11kN	27mm
70007449591	2000025	Medium Parabiner, Aluminium double action autolock	16kN	19mm

## 3M™ DBI-SALA® Rollgliss™ Rescue Ladder



8516294

## 3M™ DBI-SALA® Spreader Bar



3M Order Code	Model #	Description
70007494928	8516294	2.4 m, includes 3 connecting karabiners
70007494951	8516316	Anchorage plate for mounting ladder to a davit arm or anchorage point

3M Order Code	Model #	Description
70007926135	E522-SB1	Spreader bar with double action karabiner connections
70007936308	E522-SB3	Spreader bar with triple action karabiner connections

# Descent & Rescue

## 3M™ Protecta® Tripod & Confined Space Kits



3M Order Code	Model #	Description
70007932364	AM100	Tripod, 1.4 - 2.4m
70007936274	AA600AU	With Personnel Winch, includes: AM100 tripod, AT200/I20 Winch, AK0100 bag, mounting bracket and pulley. Comes with PROTECTA (AB123M) harness
70007940581	AA610AU	With Type 3 SRL, includes: AM100 tripod, 3591002 Type 3 retrieval SRL, AK0100 bag, mounting bracket & pulley

## 3M™ Protecta® Confined Space Accessories



3M Order Code	Model #	Description
70007780078	AT052/1	Pulley with karabiner for use on tripod
70007464897	3590498	Fixing bracket for 3591002 retrieval SRL
70007932380	AK0100	Tripod Bag
70007635736	AK020A1	Pulley

## 3M™ Protecta® Confined Space Rebel™ Retrieval Self Retracting Lifeline



3M Order Code	Model #	Description
70007466314	3591002	Galvanised cable, 15 m*
70007464905	3590499	Mounting bracket for 50FT Rebel winch and SALA Tripod.

\*When ordering the Rebel™ Retrieval Fall Arrest SRL for use with the Tripod, order the AT052/1 pulley and the 3590498 fixing bracket.

## 3M™ Protecta® Confined Space Rescue Winch



3M Order Code	Model #	Description
70007784153	AT200/I20	Automatic locking system, 20 m**

\*\*When ordering the Rescue Winch for use with the Tripod, order the AT052/1 pulley. Alternatively order the complete system, part no. AT200/I20/P

# 3M™ DBI-SALA® FlexiGuard™ Solutions.



### C-Frame rail fall arrest system.

A versatile system designed to be moved manually or with the use of a tow bar and service vehicle to provide safe access, horizontal movement and total fall protection on or near sensitive equipment for up to two users.



### A-Frame rail fall arrest system.

A secure anchor point in a portable structure giving the worker increased coverage and protection. Ideal solution for a workshop environment where space is limited. System is designed to be moved manually, provides horizontal movement and total fall protection for up to two users.



### Ladder fall arrest system.

Adjustable in height that provides easy access to elevated work areas of different heights such as fuselage, wing and general maintenance areas with fall protection from the ground up for multiple users, for the duration of the work being performed.



### Portable tanker access ladder system - fall arrest.

The Portable Tanker Access Ladder System (PTALS) provides easy access to elevated work areas with fall arrest rated tie-off for one operator from the ground up for the duration of the work being performed. System configurations may include but not limited to guardrails, SRL's or confined space entry equipment.

# Speciality Systems



## Counterweight rail fall arrest system.

Designed as a versatile solution to provide an overhead anchor point for up to two users while working at heights. These systems are designed to be counterbalanced by concrete allowing for close positioning to the work surface without obstructing the equipment being accessed.



## Portable tanker access ladder system - work positioning.

The Portable Tanker Access Ladder System (PTALS) combines easy access to elevated work areas with fall protection and work positioning for one operator for the duration of the work being performed. System configurations may include but not limited to guardrails or confined space entry equipment.



## M100 & M200

Get the coverage you need with this versatile new fall protection system. Available in both the M100 and M200 Series, the 3M™ DBI-SALA® Flexiguard™ Modular Jib System features a simplified design that enhances worker safety in multiple applications. Increased rail-length configurations improve working coverage while a new design facilitates easier system transport.



Each FlexiGuard solution is driven by our customers' needs and is dependent on the industry, environment and specific design constraints, including government standards. For complete peace of mind DBI-SALA's FlexiGuard Access Systems offer a complete solution that is ready to use.

Due to the technical nature of all these speciality systems and applications, a degree of customisation is required. Please contact 3M Fall Protection for more information.

# 3M™ DBI-SALA® Engineered Systems.

Our range of engineered horizontal systems provide a choice of fall protection solutions that allow users to most effectively resolve the risks associated with work at height in a wide range of applications, and comply with workplace safety regulations.

## RoofSafe™ cable system.

The system attaches to roof sheeting and can span up to 12 m between supports to provide continuous hands-free access and protection.



## RoofSafe™ rail system.

The only direct to roof rail system that can facilitate changes in direction and roof slopes, ensuring continuous safe roof access for fall arrest and rope / suspended access applications.



## 3M™ DBI-SALA® 8 mm permanent horizontal lifeline system.

This system attaches to the structure and is well suited to modern building projects and a wide range of industrial safety applications.



## UniRail™ system.

Can be fitted to a wide range of structures and can support multiple workers for both fall arrest and rope / suspended access applications.



## The Uni-8™ overhead system.

This quality safety solution can support heavy fall arrest and controlled rate descent devices, ensuring free and unhindered movement for the worker when carrying out work at height.

Contact us for more information or to speak with one of our Systems Specialists.



## 3M™ Fall Protection Accessories







**RFID retrofit tags are also available for use on all brands of harnesses, lanyards, self-retracting lifelines or other equipment such as gas detectors, tools, ladders & fire extinguishers that require inspection.**

3M Order Code	Model #	Description
70007930715	E810-DUAL	Yoke Harness Extension, dual, for rescue
70007933834	E810-SINGLE	Yoke Harness Extension, single, for rescue
70007925780	E831	Dorsal Extension, retrofit
70007925004	E838	Utility Tool Pouch - 2 Pocket
70007938817	E839	Lanyard Stowage Points
70007400479	1000570	Derrick Belt, for use with ExoFit NEX™ Derrickmans harness
70007432340	1150011	Suspension Seat, for use with ExoFit NEX™ climbing, Sit and Derrickmans harness
70007424396	1150414	Suspension Seat, for use with any brand/style of harness
70007433355	1150174	Harness Hydration System
70007925137	9501403	Suspension Trauma Straps
70007607438	9501207	Delta™ Comfort Back Pad
70804401902	CL002	Custom Harness Labels
70007925848	G029-10	Harness Storage Bag
AT010644154	9598649	Draw String Bag
70007937215	G029-NEX	Harness Storage Backpack
70007932224	8700217	Equipment Duffel Bag, small
70007931291	8700547	Equipment Duffel Bag, standard
70007929493	1900-0000	Equipment/Kit Storage Bag, standard
70007927224	G029-3	Equipment/Kit Storage Bag, large
70007939138	AK066AU-BKP	Roofers Kit Backpack
70007947529	G029-PRO	Harness Storage Bag
70007938817	E839	Lanyard Stowage Points
70007932224	8700217	Storage Bag 5 L, orange/black, extra small - fits approx. 7 m x 11 mm rope
70007931341	8700225	Storage Bag 25 L, yellow, small - fits approx. 50 m x 11 mm or 25 m x 13 mm rope



# Fall Protection for Tools

From construction sites to oil rigs, 3M™ DBI-SALA® Fall Protection for Tools makes work environments safer and more productive by drastically reducing falling object incidents that can result in personal injury, equipment damage, and tool loss.

## 3M™ DBI-SALA® Attachment Points

Image to Scale

### D-Rings

- D-rings can be attached to virtually any tool under 2.3 kg or 0.9 kg using our Quick-Wrap Tape
- Creates an attachment point in less than a minute.
- Dual D-rings allow for 100% tool tie-off during tool transfers.



3M Order Code	Model #	Description	Load Rating	Quantity	Non-Conductive
70007448809	1500003	D-ring 1.3 cm x 5.7 cm	0.9kg	10 Pack	No
70007448825	1500005	D-ring 0.5" x 2.25" (1.3 cm x 5.7 cm) non-conductive	0.9kg	10 Pack	Yes
70007448841	1500007	D-ring 1" x 3.5" (2.5 cm x 8.9 cm)	2.3kg	10 Pack	No

### Heavy Duty Quick-Wrap Tape

- Heavy duty 2.5 cm wide tape conforms to the shape of whatever it is applied to.
- Used with our D-Rings and Tool Cinch Attachments to create instant tethering points on virtually any tool.
- Made from a self-fusing silicone rubber that leaves no adhesive or residue behind.
- Inner fiberglass webbing increases the strength of the tape and makes the tape resistant to sharp objects.

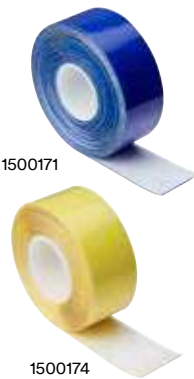

3M Order Code	Model #	Description	Quantity	Length
70804436924	1500174	Quick wrap, yellow	1	2.743m
70804440223	1500175	Quick wrap, yellow	10	2.743m
70804440199	1500171	Quick wrap, blue	1	5.486m

### Tool Cinch Attachments

- Tool Cinch Attachments feature a cinch design that allows users to quickly secure equipment up to 15.9 kg or 36.3 kg.
- Stabilization wings can be used to keep Tool Cinch Attachments in place using our Quick-Wrap Tape.



3M Order Code	Model #	Load Rating	Length	Stabilisation Wings
70007449401	1500015	V-Ring attachment point, stabilization wing	2	15.9kg
70007448866	1500011	V-Ring attachment point, stabilization wing	None	15.9kg
70007448882	1500017	V-Ring attachment point, stabilization wing	2	36.3kg

### D-Ring Cord

- Easily clinches to tools, simply pass the loop end of a D-Ring Cord through a pre-drilled hole or closed handle to create an attachment point.
- Extremely durable and reusable.



3M Order Code	Model #	Description	Load Rating	Quantity
70007448858	1500009	D-ring cord	2.3kg	10 Pack

## 3M™ DBI-SALA® Tethers & Lanyards

### Bungee Tethers

Built to be more durable and longer-lasting than the competition, our bungee tethers are third-party load rated and thoughtfully designed to prevent dropped objects.



3M Order Code	Model #	Description	Load Rating	Length (relaxed)	Length (stretched)
70007449047	1500047	Hook2Loop Bungee Tether	4.5kg	81.3cm	119.4cm
70007449054	1500048	Hook2Loop Bungee Tether (10 pack)	4.5kg	81.3cm	119.4cm
70007449062	1500049	Medium-Duty Hook2Loop Bungee Tether	15.9kg	78.7cm	132.1cm

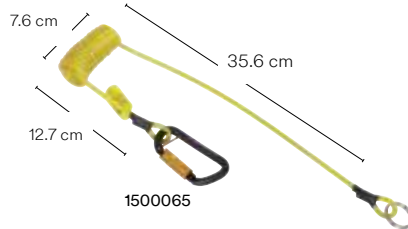
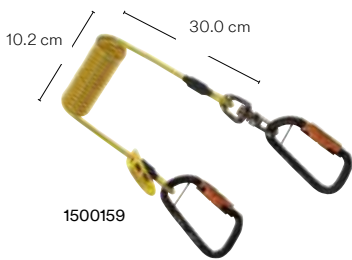

### Coil Tethers

Easy to clean and out of the way—exactly what a tether should be. The lightweight vinyl construction and ultra-compact design of our Coil Tethers makes them an ideal alternative to classic bungee tethers.

3M Order Code	Model #	Description	Load Rating	Length (relaxed)	Length (stretched)
70804431230	1500159	Hook2Hook Coil Tether with Swivel	2.3kg	100cm	157.5cm
70007449153	1500065	Hook2QuickRing Coil Tether with Tail	0.9kg	80cm	160cm
70804486085	1500178	Hard Hat Tether	1.8kg	10cm	90cm

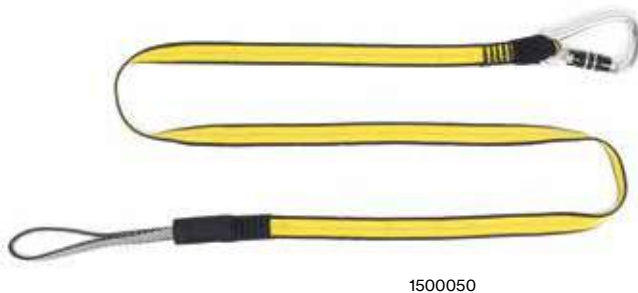

### Tool Lanyards

3M Order Code	Model #	Description	Load Rating	Length
70007449070	1500050	Medium-Duty Hook2Loop Lanyard	15.9kg	182.9cm
70007449088	1500051	Heavy-Duty Hook2Loop Lanyard	36.3kg	182.9cm

## 3M™ DBI-SALA® Tool Holsters

### Single and Dual Tool Holsters

- Single and Dual Tool Holsters are equipped with D-rings that are load rated for 2.3 kg.
- Several variants of these holsters come with Retractors (indicated below). Retractors are load rated for 0.7 kg.
- Single and dual tool holsters feature High-Visibility Reflectors and the Magnetic Tool Staging System.
- A bottom drain vent allows the holster to perform even in wet conditions.

3M Order Code	Model #	Description	Retractors included	Attachment
70007438982	1500104	Single Tool Holster with Retractor	1x	Harness
70007449328	1500102	Single Tool Holster with Retractor	1x	Belt
70007439006	1500107	Dual Tool Holster with Retractors	2x	Belt



### Tape Measure Holster with Retractor

- Designed to be used with virtually any tape measure, or the optional tape measure sleeve, allowing tape measures to be safely tethered and holstered.
- Includes a Retractor.
- The tape measure sleeve conforms to the size of nearly every tape measure.
- Features High-Visibility Reflectors.

3M Order Code	Model #	Description	Retractors included	Attachment
70007438941	1500098	Tape Measure Holster with Retractor	1	Belt
70007438958	1500099	Tape Measure Sleeve	0	N/A
70007438966	1500100	Tape Measure Holster with Retractor and Sleeve Combo	1	Belt
70007438917	1500095	Pouch Holster with Retractor	1	Belt



### Scaffold Wrench Holsters

- Quickly holster scaffold wrenches while working at height.
- Features High-Visibility Reflectors.



Back of holster features pouch for Safety Retractor 1500069. Rear feed system allows retractor to tie off a scaffold wrench while staying out of the way.

3M Order Code	Model #	Description	Retractors included	Tether included	Attachment
70007438925	1500096	Scaffold Wrench Holster with Retractor	1	N/A	Belt
70007438933	1500097	Scaffold Wrench Holster with Retractor and Hook2Loop Bungee Tether	1	1500047	Belt



# Fall Protection for Tools

## Hammer Holsters

- The Hammer Holster allows for the safe holstering of virtually any hammer under 5 lb (2.3 kg).
- D-ring on the side of the holster is load rated for 2.3 kg.
- The 1500094 combo comes with a 1500065 Hook2Quick Ring Coil Tether that is specially designed for use with the Hammer Holster. The Hook2Quick Ring Coil Tether is load rated for 2 lb (0.9 kg).
- During transport, the Hammer Holster can be locked shut with a hook and loop strap. While being used, the strap can be locked up allowing for easy hammer access and holstering.



Patent pending

**Top:** Hammer Holster is locked, preventing hammer from slipping out.  
**Bottom:** Hammer Holster is unlocked, making it suitable for active use.

3M Order Code	Model #	Description	Tether included	Attachment
70007438909	1500093	Hammer Holster	N/A	Belt
70007449302	1500094	Hammer Holster & Hook2Quick Ring Coil Tether	1500065	Belt

## Battery Holster

- Unique sleeve design conforms to the size of virtually any drill battery.
- Sleeve is cinched to the drill, allowing the drill to be tethered off while being used at height.
- 4.5 kg load rating.



3M Order Code	Model #	Description	Load Rating
70007449278	1500090	Battery Holster/Sleeve	4.5kg

## Radio Holster

- Holster adjusts to fit virtually any hand-held radio, cell phone, and many other devices.
- Can be worn from belt or harness.
- A Micro D-Ring can be placed on the back of a device, and can then be tethered to a D-ring on the front of the
- Adjustable Radio Holster using a 1500065 Clip2Loop
- Coil Tether.



Can be worn from a belt or harness.



Patent pending

1500089

3M Order Code	Model #	Description	Retractors included	Attachment
70007438891	1500089	Adjustable Radio Holster, Clip2Loop Coil Tether and Micro D-Ring	1500060	Universal

# Fall Protection for Tools

## 3M™ DBI-SALA® Tool Pouches

### Utility and Inspection Pouches

- Features two outside pockets for storing spud wrenches and two inner pockets for storing additional tools.
- Tools can be tethered to D-rings on the inside and outside of the pouch.
- Adjustable side-release closure system helps prevent objects from falling out when the pouch isn't being used.



### Small Parts Pouches

- Innovative self-closure system traps objects inside, making it nearly impossible for objects to fall out once placed in the bag.
- Easy to retrieve objects since no opening or closing is necessary.
- Compatible with most tool belts; belt loops located on back of pouch.



1500119

3M Order Code	Model #	Description
70007439097	1500130	Utility Pouch with zipper closure
70007449484	1500132	Utility Pouch with adjustable side-release closure system
70007439105	1500131	Inspection Pouch

3M Order Code	Model #	Description
70007449443	1500123	Small Parts Pouch, extra deep canvas black
70007449435	1500122	Small Parts Pouch, vinyl yellow
70007439055	1500119	Small Parts Pouch, canvas black

### Standard Safe Bucket

- Built-in connection points.
- High-quality canvas load rated for 45.4 kg, and vinyl load rated for 113.4 kg.
- Integrated carabiner and hoisting strap.
- Puncture resistant.



1500134

1500140

3M Order Code	Model #	Load Rating	Closure System	Body material	Height/diameter	Capacity
70007439121	1500134	45.4kg	Hook and Loop	Canvas	38cm/31.75cm	4673.6cm <sup>3</sup>
70007439162	1500140	113.4kg	Hook and Loop	Vinyl	38cm/31.75cm	4673.6cm <sup>3</sup>

### Safe Bucket Hard-Body

- Converts a standard soft-body Safe Bucket into a hard-body Safe Bucket.
- Our reusable hard-body Safe Bucket insert keeps your Safe Bucket standing upright, making it easier to stage tools and stay productive.
- Integrated inner pockets allow tools to be holstered and organized quickly.



3M Order Code	Model #	Description
70007449518	1500141	Reusable hard-body safe bucket insert with 4 integrated inner pockets



### Closure systems

Every Safe Bucket features either a unique, patent-pending drawstring or a locking hook and loop closure system that acts as an extra layer of spill-protection during transport and lifting. Colourful indicator tabs provide quick visual cues to indicate whether the bucket is in lockdown mode or easy-access mode.



3M Australia Pty Ltd RTO Code 45498, offers a range of training and consulting services to fit your needs, ensuring you or your employees are thoroughly trained in a practical, hands-on environment.

## In-house training facilities

Custom-built, in-house training facility at our Sydney training centres provide a hands-on training experience. Practical demonstrations, individual exercises and theoretical assessment ensure our courses build confidence and enhance safety competence when working at heights

## On-site training

Training programs can be delivered at the client's site at all locations across Australia. If you can provide the students and the location, we will provide the equipment and experienced instructors.

## Tailored training

Our courses can be tailored to suit a company's individual requirements. We specialise in the design and implementation of training for industry sectors such as: civil, construction, mining, and wind energy. We also offer specialist courses such as: roof top and bridge rescue, jump form, tower crane and swing stage rescue, post fall recovery and wind turbine rescue.

**3M Australia Pty Ltd RTO Code 45498, is accredited by the National VET Regulator, ASQA, to deliver the following nationally recognised units of competency:**



- Provide cardiopulmonary resuscitation
- Provide basic emergency life support
- Provide first aid
- Undertake manual handling
- Perform inspection
- Work in accordance with an issued permit
- Enter confined space
- Operate breathing apparatus
- Gas test atmospheres
- Confine small emergencies in a facility
- Participate in a rescue operation
- Undertake vertical rescue
- Work in a team
- Work autonomously
- Confine small workplace emergencies
- Conduct local risk control
- Apply risk management processes
- Enter and work in confined spaces
- Work safely at heights
- Perform pole top rescue
- Perform EWP rescue
- Perform tower rescue
- Perform rescue from a live LV panel
- Perform EWP controlled descent escape

**[3M.com.au/ppesafety](https://www.3m.com.au/ppesafety)**



# Comprehensive training, when and where you need it



## We've got your back

3M Fall Protection is dedicated to bringing workers home safely. Our focus drives us to design and manufacture the safest possible height safety gear.

We understand the industries we serve and listen to the workers in the field. We employ engineers to create innovative solutions and patent the products that keep workers safe at heights around the world. 3M Fall Protection offers its customers the quality products, expertise and service of the trusted 3M™ DBI-SALA® and 3M™ Protecta® Fall Protection Brands.

We take an innovative approach in bringing our products to the field. We have created international partnerships and a vast network of authorised distributors, certified installers and service centres. We offer on-site and in-house training. 3M Fall Protection is one of the world's leading manufacturers of fall protection and rescue equipment, with decades of experience and a legacy of innovation. Look for complete solutions in our extensive range of DBI-SALA® and Protecta® brands.

**“Dedicated to bringing every worker at height home safely”**



Fall Protection  
**Australia**  
Website



Fall Protection  
**New Zealand**  
Website



Fall Protection  
Demo Trailer



Contact Us

# Inspection reporting service.

Is your site safe to work at height?

- The law requires that you provide a safe work environment for staff, visitors and contractors.
- How long has it been since your last site inspection?
- Do you have a workable rescue plan?

One of the biggest challenges facing many companies is understanding where the working-at-height risks exist on site and the types of measures that can be taken to minimise them.

Our trained technicians will develop a thorough report, making recommendations that employ worlds best practice regarding fall protection in your workplace.

Contact your Regional Sales Manager or our Customer Service Centre on:

**1800 445 867 (AUS),**

**0800 212 505 (NZ).**

to book your site inspection or for more information.

## Are you looking for more?

- New Products
- Full Product Range
- Glossary (fall protection terminology)
- Instruction Manuals
- Technical Bulletins
- Find your local Sales Manager
- Safety References
- Product Images
- Find a certified Installer
- Find your local distributor
- Detailed Product Specifications
- Fall Distance Calculations

It's all available at

**[3M.com.au/ppesafety](https://3M.com.au/ppesafety)**



# Thermal Imaging

Today's firefighters operate in extreme conditions, where temperatures are capable of rising faster and where visibility is reduced in seconds. Conditions within these environments can put firefighters in situations where their safety is compromised and they must have a complete understanding of the environment. 3M Scott's Thermal Imaging Cameras come with the very latest in advanced thermal imaging, with exclusive features such as hot spot tracking, Intelligent Focus™ and tactical colourisation. Our thermal imaging cameras provide firefighters with the ultimate situational awareness.

# Ultimate combination of situational awareness.

Today's firefighters operate in extreme conditions, where temperatures are capable of rising faster and where visibility is reduced in seconds. Conditions within these environments can put firefighters in situations where their safety is compromised and they must have a complete understanding of the environment.

Thermal imaging cameras (TICs) provide users with the ultimate combination of situational awareness, lightweight design and robust features. The superior image quality enables firefighters to fully interpret a fire scene and make more-informed tactical decisions

### What is thermal energy?

Thermal energy, also known as infrared energy, is light that is invisible because its wavelength is too long to be detected by the human eye. It is part of the electromagnetic spectrum that we perceive as heat. Unlike visible light, where energy is emitted by objects only at a very high temperature, infrared energy is emitted by all objects at ordinary temperatures. The higher the object's temperature, the greater the infrared radiation emitted.

### How does a thermal camera work?

TIC detect infrared/thermal radiation temperature variations converting into electrical signals, signals convert back into images on a screen.

Thermal cameras do not depend on visible light, objects in total darkness or surrounded in smoke can be seen. TICs cannot see through walls, glass, and water, anything that absorbs thermal radiation.

3M™ Scott Fire & Safety Thermal Imaging Camera features tactical colourisation, enabling quick response.

The Hot Spot Tracker identifies the hottest object in the scene, tracks it, and displays its temperature, whilst conversely the Cold Spot Tracker locates and pinpoints thread or valve gas leaks in seconds.

#### TIC operational tasks include:

- Surveillance operations – hiding burglars, fleeing from a crime scene
- Firefighting – quickly identifying hot spots
- Search & Rescue – locating people in smoke filled or dark environments
- Maritime navigation – clearly see other vessels or people in the water at night
- Clandestine operations – find households or building with suspiciously high temperatures
- Disease control – quickly scan incoming passengers at airports for elevated temperatures.



# 3M™ Scott™ V320 Thermal Imaging Camera

The V320, featuring a 320×240 sensor, and equipped with extended battery life, provides firefighters with mission critical information that enables firefighters to make better decisions in extreme conditions.

### Features and Benefits:

- 320×240 High Resolution Sensor Provides clear images enabling firefighters to navigate through limited-visibility conditions.
- Extended Battery Life Up to Eight-hour runtime with a removable rechargeable battery.
- Single Button Single button ON/OFF provides easy deployment. No menus required.
- 3.5" High-Contrast Display Ensures the image on the display can be seen in multiple light conditions.
- Fast Startup Time Ready for use within five seconds of activating the power button – without the use of a standby mode!
- Lightweight, Durable Design Designed to withstand the extreme conditions.
- Ergonomics Ergonomically designed and balanced for comfort with a gloved hand.



3M Order Code	Model #	Description
XP101716320	8007135	V320 25Hz TIC Celsius - KIT
AT010787995		V320 25HZ TIC Kit in hard carry case
XP101716304	8007133	V320 9Hz TIC Celsius - KIT
XP101715926	8007136	V-SERIES Retractable Lanyard
XP101715918	8007137	V-SERIES Battery Charger
XP101715900	8007138	V-SERIES Charger Power Supply
XP101715892	8007139	V-SERIES Standard Battery
78815125022		KIT, TIC Truck Holder V-SERIES

**3M** Science.  
Applied to Life.™



# Reusable Respirator, Powered & Supplied Air Parts & Accessories

Please note not all parts and accessories are stocked or active in our system.  
Please contact 3M sales rep or customers service for further clarification.

NEW ZEALAND

#3MScienceOfSafety

# Parts & Accessories

## 3M™ Reusable Respirator Half Face Accessories 6000

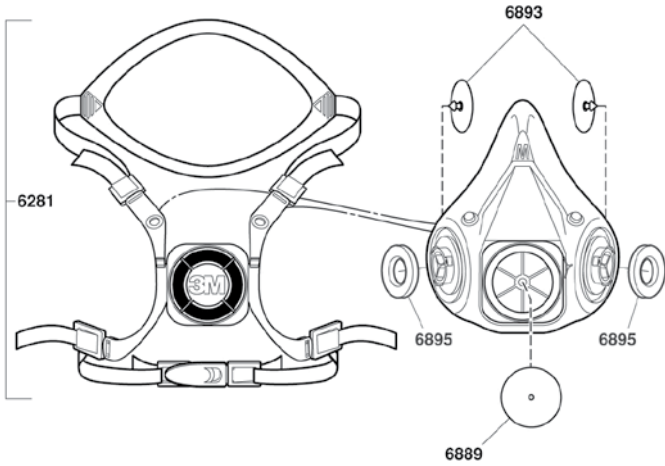

3M Order Code	Model #	Description
70070846087	6281	Standard Head Harness Assembly
70070757656	6889	Exhalation Valve
70070710986	6893	Inhalation Valve
70070710994	6895	Inhalation Gasket
70070406544	601	Quantitative CNC Fit Test Adapter 601

## 3M™ Half Face Respirator Accessories 6500QL

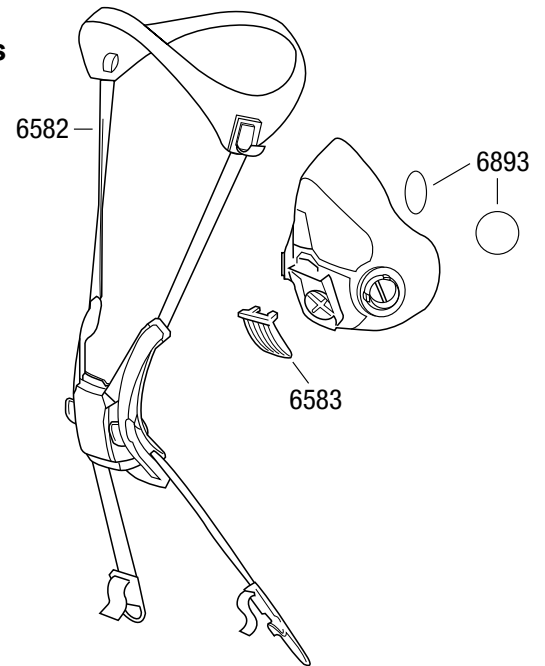

3M Order Code	Model #	Description
70071668175	6582	Head harness Cradle
70071668183	6583	Exhalation Valve
70070710986	6893	Inhalation Valve
70070406544	601	Quantitative CNC Fit Test Adapter 601

## 3M™ Half Face Respirator Accessories 7500

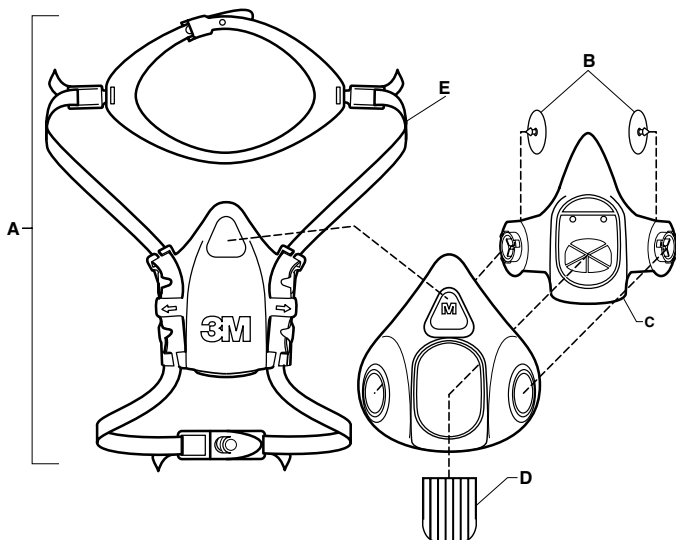

3M Order Code	Model #	Description
70071042603	7581	Head Harness Assembly (A)
70071042611	7582	Inhalation Valve (B)
70071042637	7586	Filter Holder with 2 x 7582, 1 x 7583 (C)
70071042629	7583	Exhalation Valve (D)
70071534294	7580	Respirator replacement strap (E)
70070406544	601	Quantitative CNC Fit Test Adapter 601

## 3M™ Half Face Respirator Accessories HF-800SD

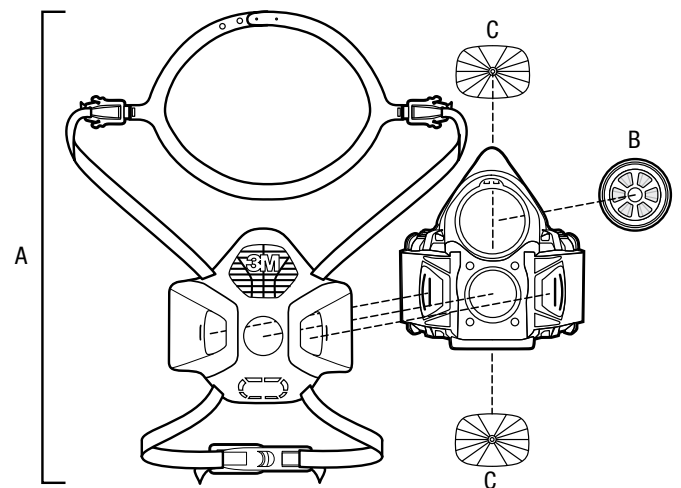

3M Order Code	Model #	Description
UU009607902	HF-800-04	Head Harness Assembly SD Version (A)
UU009620988	HF-800-05	Speaking Diaphragm (B)
UU009608314	HF-800-02	Inhale/Exhale Valve (C) Pack size. Sold as each
UU009620905	HF-800-03	Quantitative Fit Test Adapter Kit

# Parts & Accessories

## 3M™ Full Face Respirator Accessories FF-400

3M Order Code	Model #	Description
70071516846	FF-400-01	Buckle
70071516853	FF-400-02	Button
70071516861	FF-400-03	Lens replacement
70071516879	FF-400-04	Head Harness
70071516887	FF-400-05	Lens Frame Assembly
70071516895	FF-400-06	Comfort Cradle
70071516903	FF-400-07	Exhalation Valve Assembly
70071516911	FF-400-08	Bayonet Assembly
70071516929	FF-400-09	Exhalation Valve Cover
70071516945	FF-400-11	Nose Cup Assembly. Comes with 7582 inhalation valves for nose cup.
70071516960	FF-400-13	Speaking Diaphragm
70071516986	FF-400-17	Semi-permanent lens protector. Adhesive around full edge
XA006514674	102	3M Universal spectacle kit
70071042611	7582	Inhalation Valve
70071042629	7583	Exhalation Valve
70071668183	6583	Exhalation Valve
70070406544	601	Quantitative CNC Fit Test Adapter 601

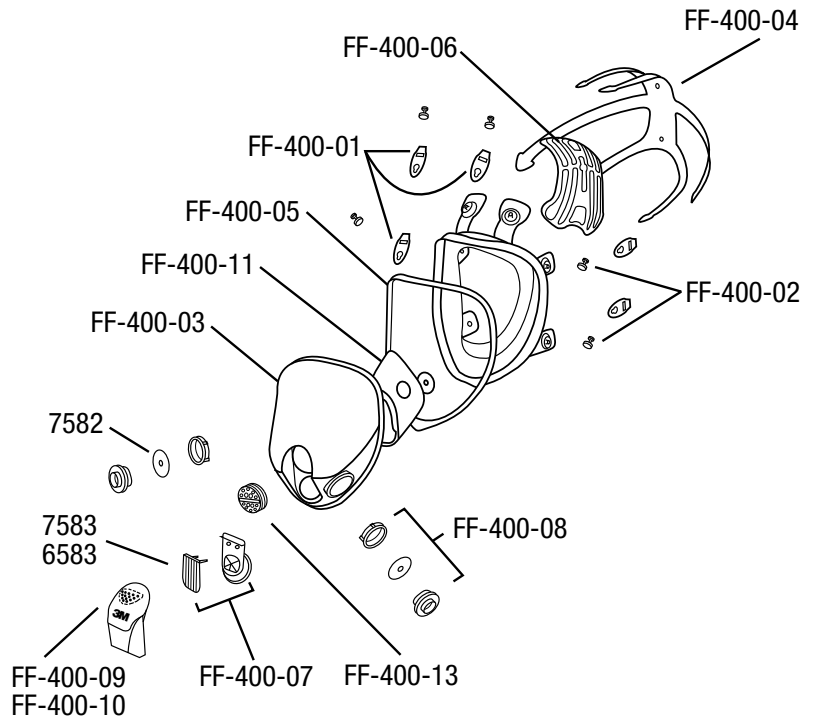

## 3M™ Reusable Respirator Full Face 6000 & 6000DIN Accessories

3M Order Code	Model #	Description
70071093010	6864	Centre Adapter Assembly (1)
70071668183	6583	Exhalation Valve (1B)
70070847051	6896	DIN Centre Adapter Gasket (1D & 2E)
70070709087	6884	DIN Port Adapter Assembly (2)
70070757656	6889	Exhalation Valve (2C)
70070079150	7890	Full face plug (2G)
70070757375	6880	Bayonet Blanking Cap (4)
70070710994	6895	Inhalation Gasket (5)
70070710986	6893	Inhalation Valve (6)
70070709160	6898	Full Facepiece Lens Assembly (7)
70070709145	6894	Nosecup Assembly (includes inhalation 6893 valves) (8)
70070709178	6899	Lens Frame Kit (9)
70070709152	6897	Head Harness Assembly - Full Face (10)
70070709103	6885	Clear Lens Cover
70070799419	6886	Tinted Lens Cover
XA006514674	102	3M Universal spectacle kit
70070406544	601	Quantitative CNC Fit Test Adapter
XP100544970	RXFTA/STAN	DIN40 Quantitative CNC Fit Test Adapter for 6000DIN

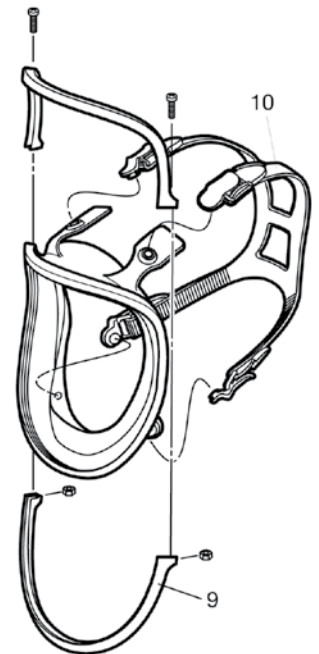
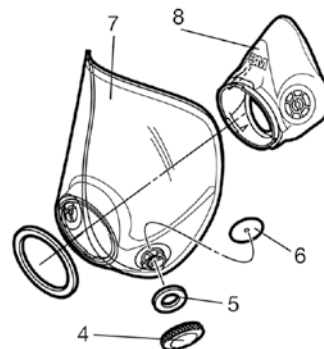
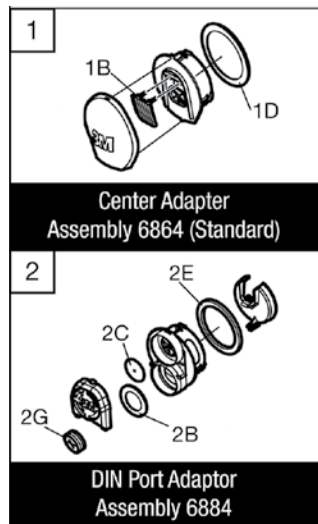



## Parts & Accessories

### 3M Resuable Respirator Full Face FF-300 (Promask Single and FM3) Spare Parts

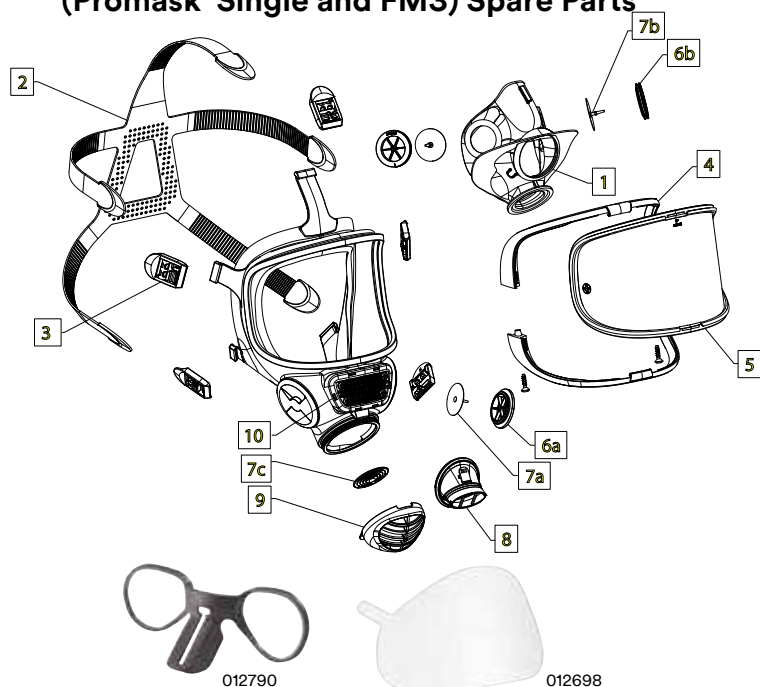

3M Order Code	Model #	Description
XP100547239	012691	Inner mask silicone with fastening ring (1)
NT070008007	012692	Rubber head harness (2)
XP100544129	012694	Harness buckle set (5 pieces) (3)
XP100547247	012693	Visor frame set (4)
XP100544137	012695	Polycarbonate visor (5)
XP100544186	012795	Polycarbonate visor (hard coated) (5)
XP100544103	012689	Valve seat set (6a, 6b)
XP100544111	012690	Valve disc set (7A 7B 7C) (LIC)
XP100544087	012687	Speech Diaphragm (8)
XP100544095	012688	Exhalation Valve Cover (9)
XP100547296	012794	Speech Channel Cover (10)
XP100547254	012697	Neckband Promask
XP100547270	012775	Webbing head harness Promask
XP100547288	012777	DIN40 Blanking Plug 40mm
XP100547189	012658	Spark Guard - Speech Diaphragm
XP100547197	012659	Spark Guard - Exhalation valve
XP100544970	RXFTA/STAN	DIN40 Quantitative CNC Fit Test Adapter
XP100544145	012698	Visor overlays (set OF 10)
XP100544160	012790	Prescription spectacle frame

### 3M Resuable Respirator Full Face FF-600F (Vision 1000) Spare Parts

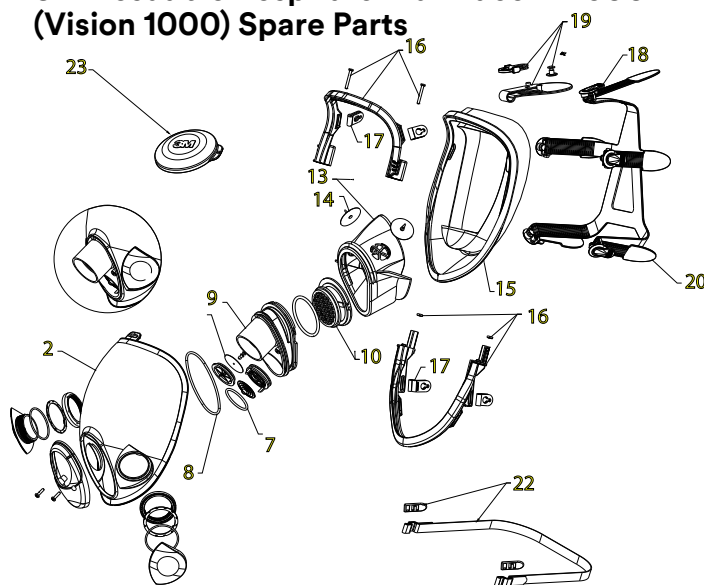

3M Order Code	Model #	Description
UU011589148	FF-600F-925	Standard Visor* (2)
UU011565155	FF-600-01	Inhalation Valve (4)
XP100062965	1027929	O-ring for exhalation valve (5pk) (7)
UU011570064	2001316	O-ring for front fitting (5pk) (8)
UU011565791	FF-600F-06	Front Cover 5/Case (9)
UU011589130	FF-600-07	Speech Diaphragm Assembly (10)
UU011589130	FF-600F-07	Speech Diaphragm Assembly 20/Case (10)
XP100544814	7171289	Inner mask & valves M/L (13)
XP100544756	7111429	Inhalation valve (6pk) (14)
XP100549177	7170289	Face seal M & M/L (15*)
XP100549185	7171089	Clamp, screws and nuts for M/L (1 set) (16*)
XP100065638	1033128	Mask hinge set (3 upper, 2 lower) (17)
XP100544806	7170789	Buckles and rollers (5pk) (18)
XP100549201	7175189	Stirrup, Rubber Link and Top Mount (1 set) (19)
XP100544798	7170489	Head harness (rubber) (20)
UU010979548	1033400	Vision 3 Head harness (polynet) (21)
XP100065687	1033178	Neckstrap rubber Promask (22)
XP100544442	052693	Pro2000 Filter covers, orange polyethylene LDPE (2pcs) (23)
XP100544764	7111499	Service pack (incl 2 exhalation valves and 6 inhalation valves)
XP100544970	RXFTA/STAN	DIN40 Quantitative CNC Fit Test Adapter
XP100545068	VCP1000	Visor overlay tear off (pk 5)
XP100123155	2015082	FF-600 & FF-600F spectacle frames

(\*) To be fitted by Service Center

### Full Face Respirator Accessories

Accessories for Full Face Respirators.

3M Order Code	Model #	Description
AT010687468	6164101E	Poly Storage Case PVC

### 3M™ Respirator Cleaning Wipe 504



3M Order Code	Model #	Description
70070317139	504	Respirator Cleaning Wipe, Alcohol-Free

# Parts & Accessories

## 3M Resuable Respirator Full Face FF-600 (Vision 4000) Spare Parts

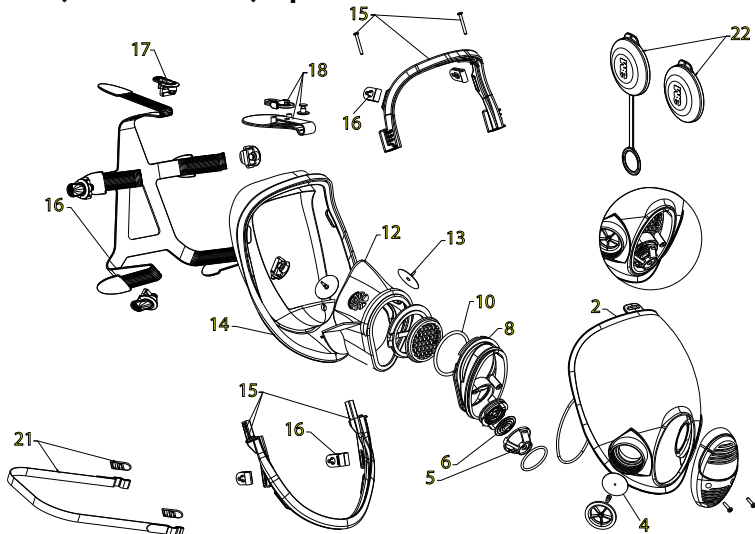

3M Order Code	Model #	Description
UU011589148	FF-600F-925	Standard Visor* (2)
UU011589072	2015853	Exhalation valve complete assembly (5*)
XP100062965	1027929	O-ring for exhalation valve (5pk) (6)
XP100094158	2001322	O-ring for speech diaphragm (5pk) (10)
XP100544756	7111429	Inhalation valve (6pk) (13)
XP100549177	7170289	Face seal M & M/L* (14)
XP100549185	7171089	Clamp, screws and nuts for M/L (1 set) (15*)
XP100065638	1033128	Mask hinge set (3 upper, 2 lower) (16)
XP100544806	7170789	Buckles and rollers (5pk) (17)
XP100549201	7175189	Stirrup, Rubber Link and Top Mount (1 set) (18)
XP100544798	7170489	Head harness (rubber) (19)
XP100065687	1033178	Neckstrap rubber Promask (21)
XP100544442	052693	Filter covers, polyethylene LDPE (2pcs) (22)
XP100065943	1033400	Vision 3 Head harness (polynet)
XP100544764	7111499	Service pack (incl 2 exhalation valves and 6 inhalation valves)
XP100544970	RXFTA/STAN	DIN40 Quantitative CNC Fit Test Adapter
XP100545068	VCP1000	Visor overlay tear off (pk 5)
XP100123155	2015082	FF-600 & FF-600F spectacle frames

(\*) To be fitted by Service Center

## 3M™ Qualitative Fit Test Kits



3M Order Code	Description
70070121457	3M™ Sensitivity Solution FT-11, Sweet (Saccharin)
70070121465	3M™ Fit Test Solution FT-12, Sweet (Saccharin)
70070121481	3M™ Fit Test Hood FT-14
70070709657	3M™ Sensitivity Solution FT-31, Bitter (Bitrex)
70070709665	3M™ Fit Test Solution FT-32, Bitter (Bitrex)

## Powerflow™ Powered Air Purifying Respirator Parts & Accessories

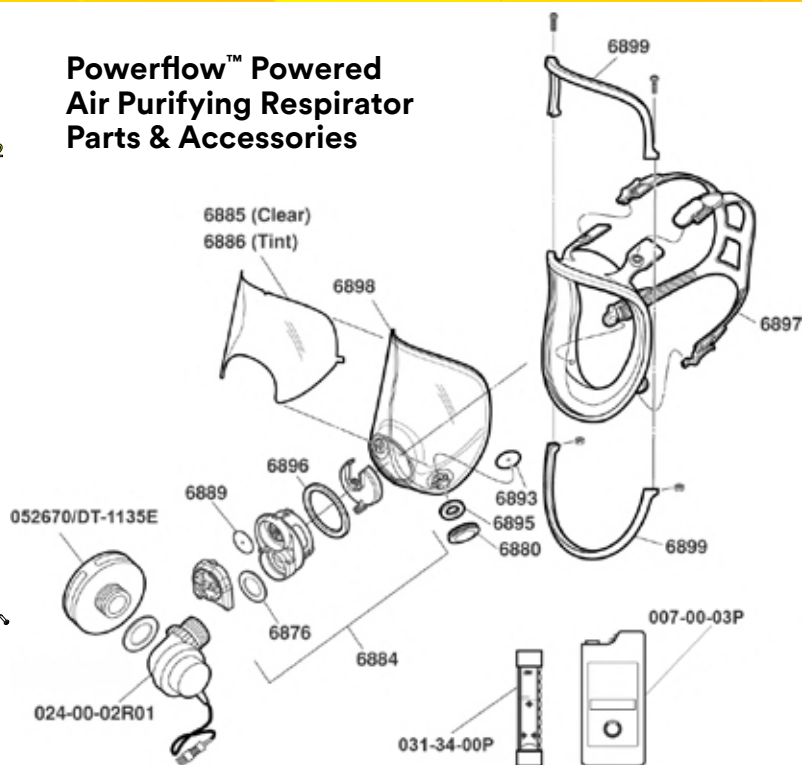

3M Order Code	Model #	Description
70070885077	024-00-02R01	Powerflow™ Turbo Unit
52000002106	007-00-03P	NiCd Battery Pack (Tubular)
AT019462269	003-00-04P	NiCd Battery Charger
XA007708051	031-34-00P	Powerflow™ Airflow Indicator
XA007706048	024-04-02P	Decontamination Kit and Cannister Cover
XP100544418	052670/DT-1135E	DT-Series (Pro2000) DT-1135E PF10
70070757375	6880	Bayonet Blanking Cap
70070709087	6884	DIN Port Adapter Assembly
70070709103	6885	Clear Lens Cover
70070799419	6886	Tinted Lens Cover
70070757656	6889	Exhalation Valve
70070710986	6893	Inhalation Valve
70070709145	6894	Nosecup Assembly (includes inhalation valves)
70070710994	6895	Inhalation Gasket
70070847051	6896	DIN Centre Adapter Gasket
70070709152	6897	Head Harness Assembly - Full Face
70070709160	6898	Full Facepiece Lens Assembly
70070709178	6899	Lens Frame Kit
XA006514674	102	3M Universal spectacle kit
70070889814	6800DIN	Medium Face Piece
70070889822	6900DIN	Large Face Piece
XP100544970	RXFTA/STAN	DIN40 Quantitative CNC Fit Test Adapter

## 3M™ Scott Trigene Solution & Wipes

- Antimicrobial respirator and surface wipes
- Available as ready-to-use wipes & pre-mixed solution or in concentrate form for dilution on-site
- TGA Registered - ARTG No: 232937 & 233129



3M Order Code	Model #	Description
AT010788142		Trigene Wipes Drum (180)
AT010648684	2008248EA	Trigene Solution 5L Concentrat Clear
AT010659616	TRIG:31	Trigene Pre-Mix 1 To 100 5L Green

# Parts & Accessories

## 3M™ TR-300+ Parts & Accessories

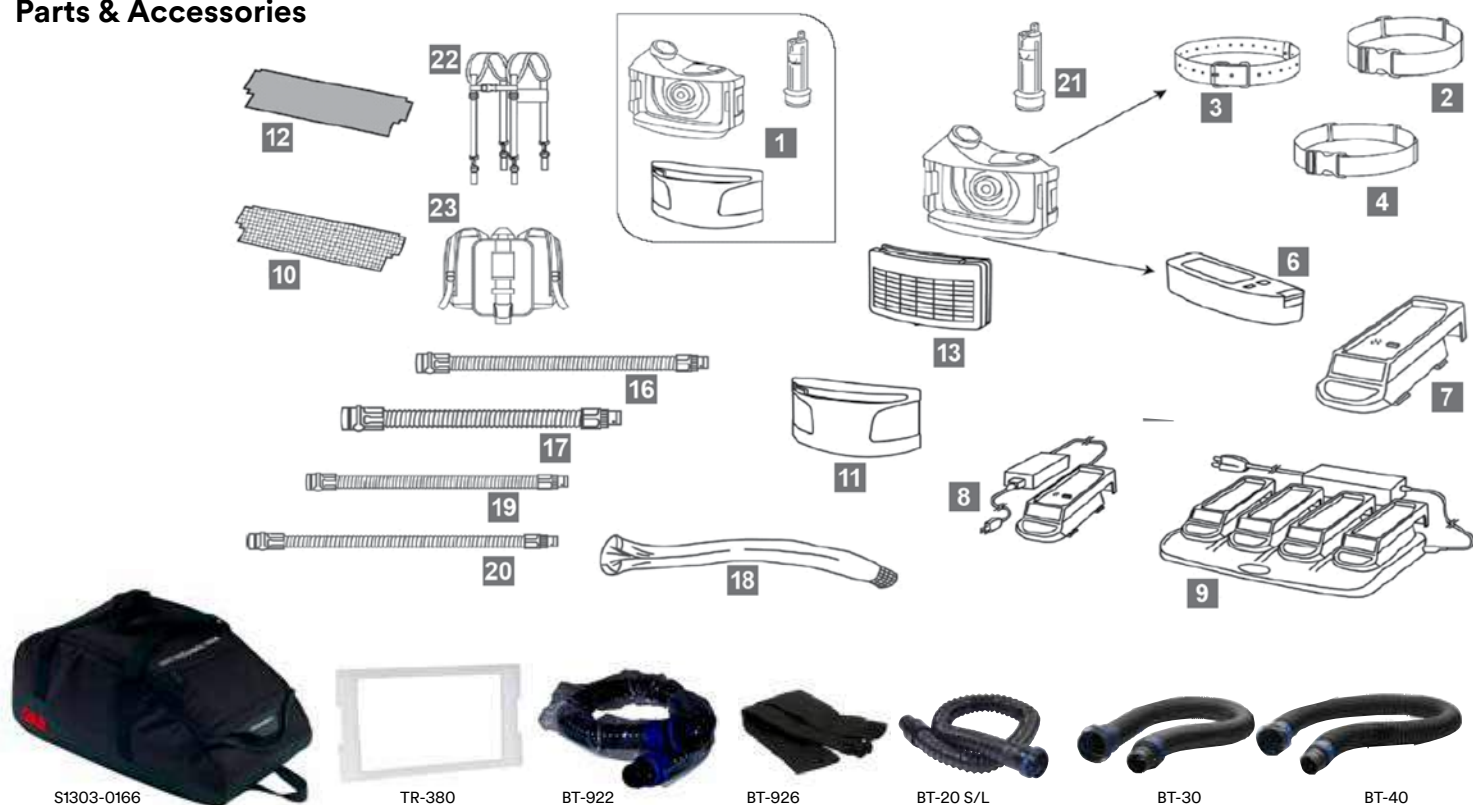

3M Order Code	Model #	Description
UU008566075	TR-302E	Air Filter Unit (1)
XA007706592	TR-325	Std Waist Belt (2)
XA007706691	TR-326	High Durability Leather Waist Belt (3)
XA007706709	TR-327	Easy Clean Waist Belt (4)
XA007706568	TR-332	High capacity battery pack (6)
XA007706667	TR-340	Charging Cradle (7)
XA007706758	TR-341A	Single Station Battery Charger, Power Supply and Lead (8)
XA007706766	TR-344A	Quad Station Battery Charger, Power Supply and Lead (9)
XA007706659	TR-362E	Spark Arrestor (10)
UU006386765	TR-371+	Versaflo Filter Cover TR-300+ (11)
AT010592650	TR-3600	Versaflo™ Prefilter (12)
70071765054	TR-3712E	Versaflo™ Filter Particulate, P3 (13)
78815069386	TR-3802E	Filter P3 plus Nuisance Organic Vapour (13)
78815069394	TR-3822E	Filter P3 & HF Plus Nuisance Acid Gases (13)
XA007706584	BT-30	Self-adjustable Polyurethane Breathing Tube L=525-850mm (16)
UU003085113	BT-40	Fixed length Heavy Duty Neoprene Breathing Tube L=840mm (17)
70071564432	BT-926	Flame Resistant Breathing Tube Cover - 1 per case (18)
XA007706527	BT-922	Breathing Tube Cover Polyethylene Clear - 1 per case (18) Breathing tube not included
UU006081895	BT-927	Breathing Tube Radiant Heat Cover - 1 per case (18)
70071533023	BT-20S	Fixed length lightweight Polyurethane Breathing Tube L=735mm 5/case (20)
XA007706576	TR-970	Air Flow Indicator (21)
520000052770	TR-329	Braces for PAPR Belt System (22)
XA007706618	BPK-01	Back Harness (23)

## TR-315A+ Powered Air Purifying Respirator Filters and Filter covers

3M Order Code	Model #	Description
CR180811422	TR-3600	Versaflo™ Prefilter (12)
70071765054	TR-3712E	Versaflo™ Filter P3 Particulate 5 BOXES/CASE (13)
78815069386	TR-3802E	Filter P3 plus Nuisance Organic Vapour (13)
78815069394	TR-3822E	Filter P3 & HF Plus Nuisance Acid Gases (13)
UU006386765	TR-371+	Versaflo Filter Cover for TR-300+ (11)

# Parts & Accessories

## 3M™ TR-600 & TR-800 Parts & Accessories

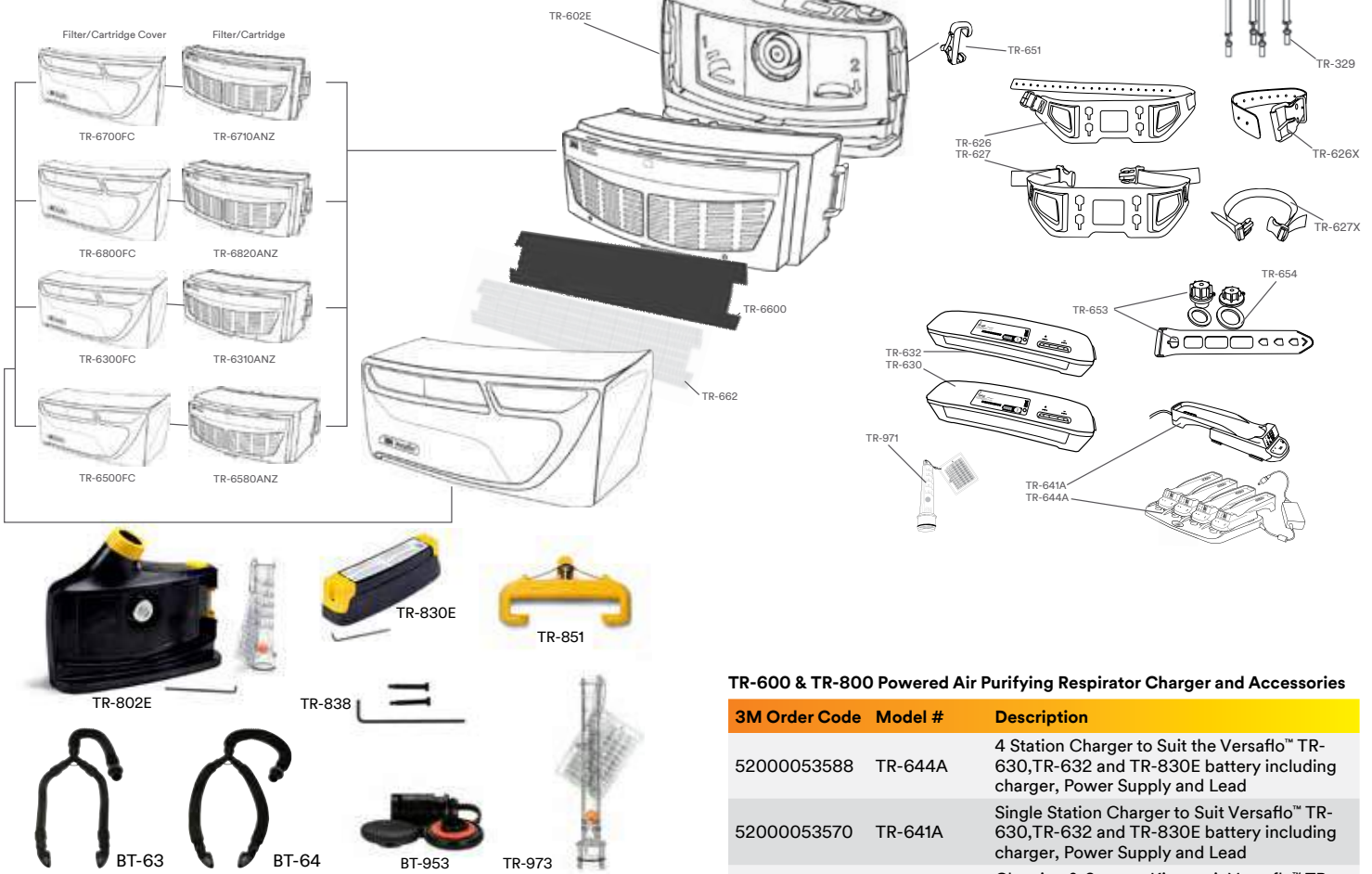

### TR-600

3M Order Code	Model #	Description
70071667862	TR-602E	TR-602E Powered Air Turbo unit
70071622081	TR-630	Standard Battery TR-630
52000053554	TR-632	TR-632 Versaflo™ High Capacity Battery
70071622081	TR-651	Filter Latch TR-651

### TR-800

3M Order Code	Model #	Description
70071730900	TR-802E	TR-802E PAPR Motor/Blower 1/CS
70071697125	TR-838	TR-838 Battery attachment tool
70071697117	TR-830	TR-830 Battery, Intrinsically safe 1/CS
70071697133	TR-851	TR-851 Filter latch assembly

### TR-600 & TR-800 Powered Air Purifying Respirator Filters and Filter covers

3M Order Code	Model #	Description
70071618246	TR-6600	TR-6600 Versaflo™ Pre-Filter
70071618261	TR-6700FC	Filter Cover to Suit Versaflo™ TR-6710ANZ
NT070007736	TR-6710ANZ	High Efficiency Particle Filter Versaflo™
70071622040	TR-6800FC	Filter Cover to Suit Versaflo™ TR-6820ANZ Nuisance Odour* P3 Filter
UU008996207	TR-6820ANZ	Nuisance Odour* Plus P3 Filter
70071622065	TR-6300FC	Filter Cover to Suit Versaflo™ TR-6310ANZ P3 Filter
NT070007769	TR-6310ANZ	A1P3 Filter For Organic Vapours includes a P3 filter
70071622073	TR-6500FC	Filter Cover to Suit Versaflo™ TR-6580ANZ
NT070007777	TR-6580ANZ	A1B1E1HgP3 Filter For Organic Vapours, Acid Gases, In-organic vapours and Mercury including a P3 Filter
70071618253	TR-662	Spark Arrestor

### TR-600 & TR-800 Powered Air Purifying Respirator Charger and Accessories

3M Order Code	Model #	Description
52000053588	TR-644A	4 Station Charger to Suit the Versaflo™ TR-630, TR-632 and TR-830E battery including charger, Power Supply and Lead
52000053570	TR-641A	Single Station Charger to Suit Versaflo™ TR-630, TR-632 and TR-830E battery including charger, Power Supply and Lead
70071618428	TR-653	Cleaning & Storage Kit to suit Versaflo™ TR Systems
70071618253	TR-662	Spark Arrestor TR-662 to suit Versaflo™ TR-600
70071668076	TR-971	Airflow Indicator for TR-600/TR-800 Versaflo™ Unit
78815045279	TR-627	Easy Clean Belt
52000053521	TR-626	High Durability Leather Belt
XA007706618	BPK-01	Back Harness
70071651692	TR-655	Enables TR-600/TR-800 PAPR to be mounted on backpack BPK-01
70071618147	TR-626X	3M™ Versaflo™ High Durability Belt Extender
70071618162	TR-627X	3M™ Versaflo™ Easy Clean Belt Extender
70071533015	BT-20L	Fixed length lightweight Polyurethane Breathing Tube L=965mm
70071533023	BT-20S	Fixed length lightweight Polyurethane Breathing Tube L=735mm
XA007706584	BT-30	Self-adjustable Polyurethane Breathing Tube L=525-850mm
UU003085113	BT-40	Fixed length Heavy Duty Neoprene Breathing Tube L=840mm
52000052770	TR-329	Braces for PAPR Belt

### BT-63 & BT-64 Breathing Tube for approved tight fitting facepieces

3M Order Code	Model #	Description
70071730876	BT-64	Versaflo™ Heavy Duty Tight Fitting Breathing Tube BT-64 1 EA/Case
70071730934	BT-63	Versaflo™ Length Adjusting Tight Fitting Breathing Tube BT-63 1/Case
70071730892	BT-953	Versaflo™ Cleaning & Storage Kit BT-953, for BT-63/64 Breathing Tubes 1/case
70071730884	TR-973	Versaflo™ Air Flow Indicator TR-973, for TR-600 PAPR with BT-63/64 Breathing Tube 1/case

# Parts & Accessories

## Versaflo™ M-100 (Discontinued)/ M-200 Common Accessories, Spares and Options

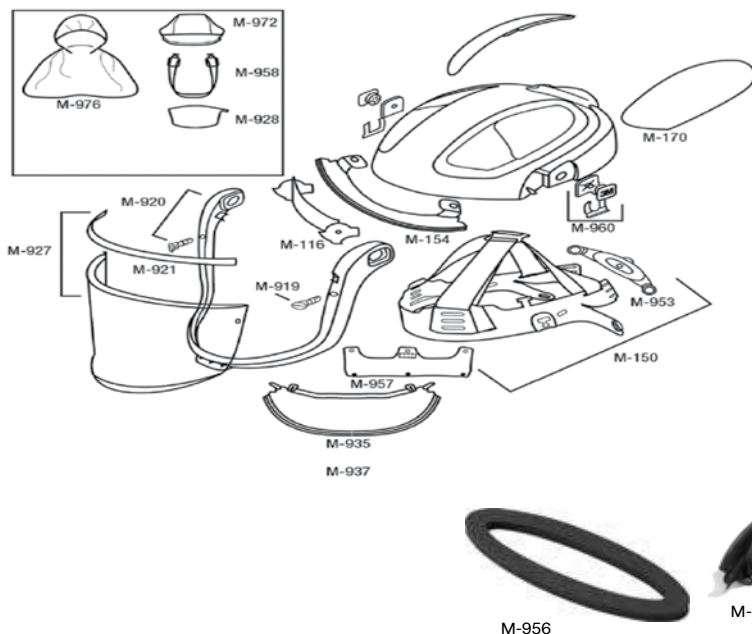

## Versaflo™ M-300 Common Accessories, Spares and Options

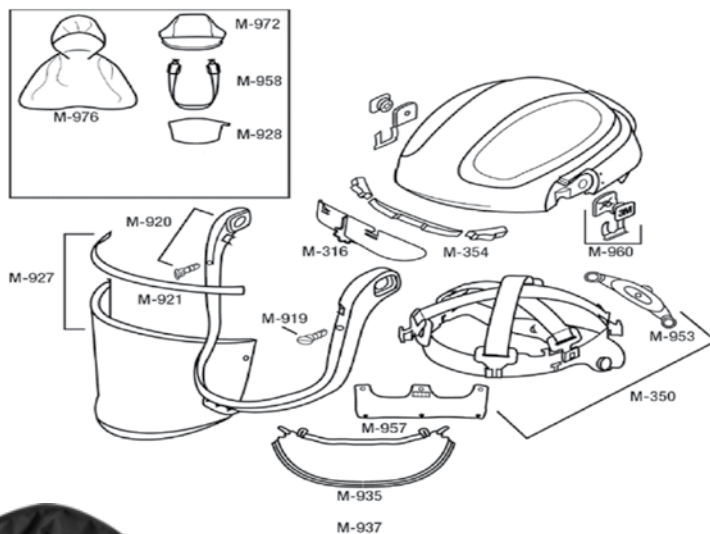

3M Order Code	Model #	Description
70071564168	M-116	Airflow Deflector
UU003029491	M-150	Head Suspension - 1 per case
UU003029723	M-154	Forehead Seal - 1 per case
70071544970	M-170	Versaflo M-170 Faceshield Head Inserts for M-100
70071564309	M-919	Visor Frame Buttons - 10 per case
70071564317	M-920	Visor Frame Assembly - 1 per case
70071564325	M-921	Visor Gasket - 5 per case
UU003029442	M-927	Coated Visor - 5 per case
70071564341	M-928	Peel-Off Visor Covers - 40 per case
UU003029202	M-935	Standard Faceseal - 5 per case
70071564374	M-937	Flame resistant Faceseal - 5 per case
UU003029772	M-956	Size reducing Comfort Pad - 10 per case
XA007705925	M-957	Forehead Comfort Pad - 20 per case
XA007705909	M-958	Chin Strap - 1 per case
70071564390	M-960	Visor Pivot Kit - 1 per case
UU003029434	M-972	Flame resistant head-top cover - 1 per case
UU003029780	M-976	Head, Neck, Shoulder Cover - 1 per case

3M Order Code	Model #	Description
70071564218	M-316	Airflow deflector
70071564226	M-350	Helmet head suspension
UU003029749	M-354	Forehead Seal
70071564309	M-919	Visor Frame Buttons - 10 per case
70071564317	M-920	Visor Frame Assembly - 1 per case
70071564325	M-921	Visor Gasket - 5 per case
UU003029442	M-927	Coated Visor - 5 per case
70071564341	M-928	Peel-Off Visor Covers - 40 per case
UU003029202	M-935	Standard Faceseal - 5 per case
70071564374	M-937	Flame resistant Faceseal - 5 per case
UU003029772	M-956	Size reducing Comfort Pad - 10 per case
XA007705925	M-957	Forehead Comfort Pad - 20 per case
XA007705909	M-958	Chin Strap - 1 per case
70071564390	M-960	Visor Pivot Kit - 1 per case
UU003029434	M-972	Flame resistant head-top cover - 1 per case
UU006077661	M-973	Radiant Heat Cover for M-300
UU003029780	M-976	Head, Neck, Shoulder Cover - 1 per case
UU008014308	MT7V/1	Dynamic Microphone (including helmet attachment)
UU008013581	MT53V/1	Electret Microphone (including helmet attachment Z3AF)

## Versaflo™ S-Series Parts & Accessories

3M Order Code	Model #	Description
52000045980	S-605	Replacement Hood for S-655 - 1 per box
52000046004	S-607	Replacement Hood for S-657 - 1 per box
52000046020	S-707	Replacement Hood for S-757 - 1 per box
70071533312	S-805	Replacement Hood for S-855 - 5 per box
AT010584301	S-920L	Visor Cover for Integrated Harness Hoods S-100, S-300, S-400 & S-500 Assemblies (L) - 10 per pack
AT010584319	S-920S	Visor Cover for Integrated Harness Hoods S-100, S-300, S-400 & S-500 Assemblies (S) - 10 per pack
52000046103	S-922	Visor Cover for Reusable Harness Hoods S-600, S-700 & S-800 Assemblies - 10 per pack
70071533395	S-950	Premium Head Suspension for S-600, S-700 & S-800 Assemblies - 1 per case
52000046152	S-953	Comfort Pad for S-600, S-700 & S-800 Assemblies - 5 per bag



# Parts & Accessories

## Versaflo™ M-400 Common Accessories, Spares and Options

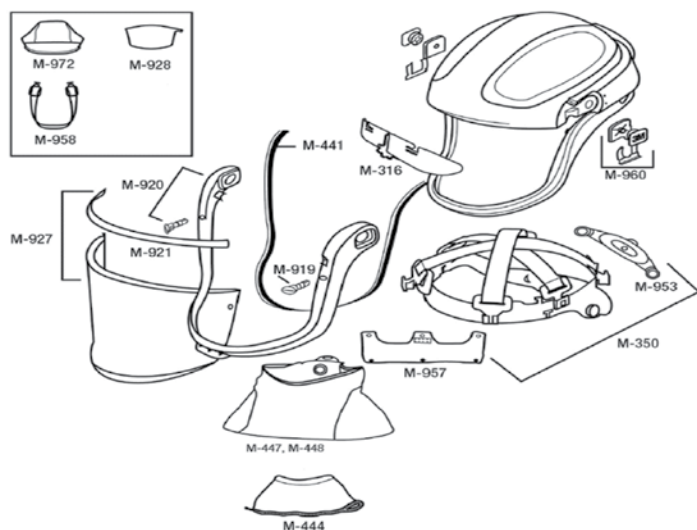

3M Order Code	Model #	Description
70071564218	M-316	Airflow deflector
70071564226	M-350	Helmet head suspension
UU003029475	M-441	Jaw Gasket
UU008294819	M-444	Inner collar
UU008294108	M-447	Versaflo Flam Resist Out Shroud
UU003029509	M-448	Versaflo High Durab Outshroud Eu 1 / Case
70071564309	M-919	Visor Frame Buttons - 10 per case
70071564317	M-920	Visor Frame Assembly - 1 per case
70071564325	M-921	Visor Gasket - 5 per case
UU003029442	M-927	Coated Visor - 5 per case
70071564341	M-928	Peel-Off Visor Covers - 40 per case
52000183096	M-953	Headband back part
UU003029772	M-956	Size reducing Comfort Pad - 10 per case
XA007705925	M-957	Forehead Comfort Pad - 20 per case
XA007705909	M-958	Chin Strap - 1 per case
70071564390	M-960	Visor Pivot Kit - 1 per case
UU006081887	M-967	Gold Over Visor UV/IR Shade 5
UU006081861	M-961	Over Visor Frame
70071564408	M-972	Flame resistant head-top cover - 1 per case
UU006077679	M-975	Radiant Heat Cover for M-400

## 3M™ Jupiter™ Turbo System Accessories (Jupiter PAPR Discontinued, spares and components available until stock depleted. Filters available till December 2022)

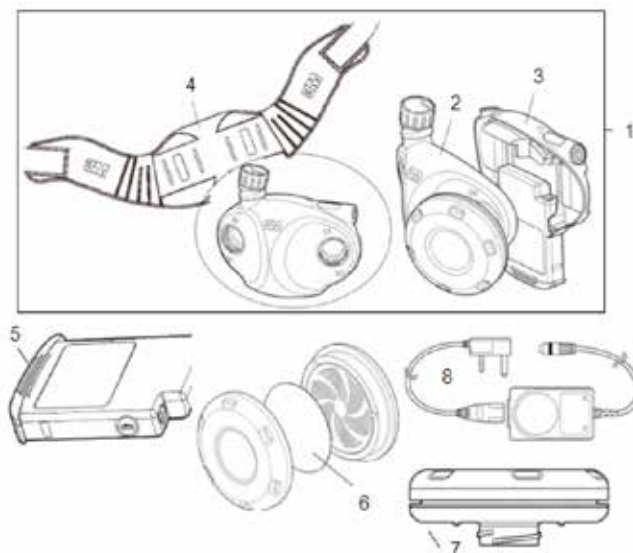

3M Order Code	Model #	Description
XA007706071	085-01-00P	Blower Module (2)
XA007706253	085-06-10P	Control Module (3)
XA007706360	BLT-12	Decontamination Belt (4)
52000043803	007-00-64P	NIMH Battery Pack (5)
52000044579	085-12-00P	4 Hour IS Battery and IS Pouch Jupiter (5)
CR180804708	461-00-02P24	Pre Filter Discs - 24 per pack (6)
CR180803981	450-00-25	Particulate Filter - P3 PAPR (7)
CR18080399	453-00-25P	Organic Vapor & Particulate Filter - A1P3 (7)
CR180806042	453-09-25	Multigas & Particulate - A1B1E1K1P3 PAPR (7)
AT010596396	003-00-58PAUS	Battery Charger, CHG-02 (8)
70071533015	BT-20L	Fixed length lightweight Polyurethane Breathing Tube L=965mm
70071533023	BT-20S	Fixed length lightweight Polyurethane Breathing Tube L=735mm
XA007706584	BT-30	Self-adjustable Polyurethane Breathing Tube L=525-850mm
UU003085113	BT-40	Fixed length Heavy Duty Neoprene Breathing Tube L=840mm
52000052770	022-25-10P4	Braces for Jupiter Belt System
XA007706618	BPK-01	Back Harness
XA007708028	021-14-12P	Jupiter™ Airflow Indicator
AT019202582	902-03-00	Jupiter™ IS Turbo Battery and Pouch



## High heat accessories

3M Order Code	Model #	Description
UU006077661	M-973	Radiant Heat Cover for M-300
UU006077679	M-975	Radiant Heat Cover for M-400
UU006081861	M-961	Over Visor Frame
UU006081887	M-967	Gold Over Visor UV/IR (Shade 5)
UU006081895	BT-927	Radiant Breathing Tube Heat Cover



# Parts & Accessories

## 3M™ PF-600E-ASB (Proflow SC160) PAPR Parts

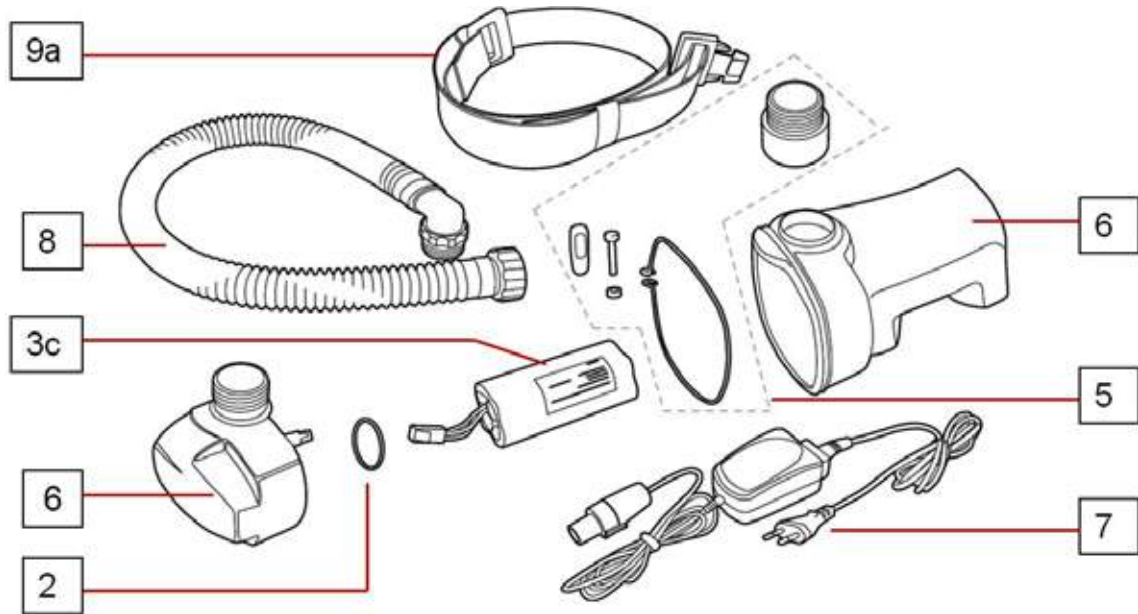

3M Order Code	Model #	Description
XP100141710	2027037	PF-931 PAPR Bayonet adaptor pack upgrade kit (needs to be added to Proflow SC160 for using FH1, FH2 & FH21) (10)
XP100544533	063791	Universal charging kit (7)
XP100544541	063799	SC-BT-55 EPDM hose (angle & DIN) 80cm for use with FM3, FM4 (comes standard with PF-600E-ASB (Proflow SC160)) (8)
XP100123775	2015430	PVC belt & buckle PF-600E-ASB (Proflow SC160) Green (9a)

## PF-600E-ASB (Proflow 160) Accessories & Spare Parts

Our extensive range of accessories gives you the option to configure Proflow to your preference.



ADP-03



052693

3M Order Code	Model #	Description
UU011003157	ADP-03	Adaptor connect Proflow to M- & S-Series
XP100547734	063596	Shoulder Harness
XP100548054	064527	Shower cover
XP100544442	052693	Filter covers (orange) (2pcs)
XP100544269	042507	Filter DIN End caps (black) (1pc)
XP100545068	VCP1000	FF-600 (Vision/FM4) Visor covers/Tear offs
XP100137106	2023305	PF-600E-ASB (Proflow SC160) Accessory Pack - 1 x blower outlet cap, 2 x filter inlet plugs
XP100139458	2025641	Storage Carry Case PAPR Black
XP100213188	5000803	Large PAPR Storage Tub and Lid
XP100124740	2015897	Face Mask Storage Box and Lid
AT010687468	6164101E	Storage Poly bag PVC

## Airstream™ Filters (Discontinued 2021. While stocks last)



3M Order Code	Model #	Description
52000044256	060-23-04P	Main Filter - PAPR P2 H/D - 10 per pack
52000044231	060-23-11P	Main Filter - PAPR GP2 - 5 per pack

# Parts & Accessories

## Vortex Cooling Airline Belt System V-100 Parts and Accessories



902-02-18

## Vortex Heating Airline Belt System V-200 Parts & Accessories



V-211

902-02-85

3M Order Code	Model #	Description
AT019184244	902-02-18	Cooling Airline Kit with adjustable BT-30 Breathing Tube

3M Order Code	Model #	Description
AT010589466	902-02-85	Heating Airline Kit with BT-30 Breathing Tube
70070799112	V-211	Vortemp Muffler Kit

## V-300 Air Regulating Valve Airline Kit Parts & Accessories



902-01-78

V-211

3M Order Code	Model #	Description
AT019184236	902-02-17	V-300 Standard Airline Kit with BT-30 breathing tube
70070799112	V-211	Vortemp Muffler Kit



## Parts & Accessories

### 3M™ Versaflo™ Supplied Air Respirator V-500E Parts & Accessories



3M Order Code	Model #	Description
XA007706675	V-500E	Supplied Air Regulator (Excludes breathing tube)
52000017831	023-05-51P5	Carbon Filter & O-Ring Kit (5 x Replacement Filters plus 10 x O-Rings) Note: Carbon filter recommended replacement 6 monthly
AT019184327	901-00-81	Airline Coupling, Male BSPT 1/4
XA007706592	TR-325	Std Waist Belt
XA007706691	TR-326	High Durability Leather Waist Belt
XA007706709	TR-327	Easy Clean Waist Belt

### Airline Hose CEJN

CEJN Airline Breathing Hose to connect V-100, V-200, V-300 & V-500 to 3M Breathing Panels with CEJN connection

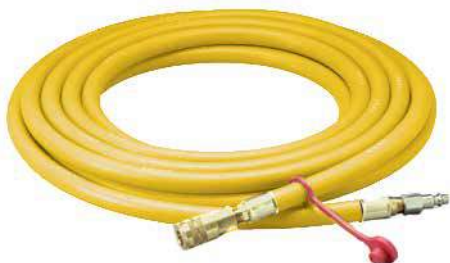

3M Order Code	Model #	Description
AT019165698	901-00-54	Breathing Hose 15m - CEJN
AT019165714	901-00-56	Breathing Hose 7.5m - CEJN

### Stethoscope Airline Systems Full Facepiece Sets Parts



3M Order Code	Model #	Description
70070613214	SA-2500	Stethoscope Breathing Tube
70070710119	SA-2600	Combination Dual Airline Breathing Kit
70070611606	SA-1007	Regulating Valve, belt & Clip
AT010589458	901-00-71	SA-2000 Dual Airline Kit complete with SA-2500 stethoscope breathing tube, CEJN Fitting and SA-1007 valve regulator
AT019202897	902-03-15	SA-2100 Combination Dual Airline Kit complete with SA-2600 stethoscope breathing tube, CEJN Fitting and SA-1007 valve regulator. Capability of fitting negative pressure filters

### 3M™ Scott Airline Hoses

For use with 3M Scott Breathing air filters, Flite COV, Modulair



3M Order Code	Model #	Description
XP100069127	1051463	10 Mtr Black PVC Hose With CEN Couplings
XP100069143	1051467	20 Mtr Black PVC Hose With CEN Couplings
XP100069168	1051471	30 Mtr Black PVC Hose With CEN Couplings
AT010700477	RXMCT	Airline Fitting Female With Male Thread
XP100069234	1051482	10m Hose Airline Antistatic With Stripe With CEN Couplings
XP100069267	1051488	30m Hose Airline Antistatic With Stripe With CEN Couplings
XP100069283	1051493	50m Hose Airline Antistatic With Stripe With CEN Couplings

## Parts & Accessories

### 3M™ Scott Airline Outlet Panel

For use with 3M Scott CEN Airline Hoses, Flite COV, Modular. Recommended filter replacement every 12 months for Upper and lower filter or when oil odour is detected for lower filter.



3M Order Code	Model #	Description
XP100141249	2026772	AFU-4-MAN Four man airline filter unit
AT010655424	KA009AA	Replacement lower filter for BA21BOPT (purchased prior Jun07)
AT010655416	KA006AC	Replacement upper filter for BA21BOPT (purchased prior Jun07)
AT010655432	KA010AA	Replacement lower filter for BA21BOPT (purchased after Jun07)
AT010655440	KA010AC	Replacement upper filter for BA21BOPT (purchased after Jun07)

### Supplied Air Breathing Tubes

Breathing tubes to connect the V-100, V200, V-300 & V-500 regulators to the S-Series and M-Series headtops and hoods.



BT-20 S/L



BT-30



BT-40



BT-922



BT-926

3M Order Code	Model #	Description
70071533015	BT-20L	Fixed length lightweight Polyurethane Breathing Tube L=965mm
70071533023	BT-20S	Fixed length lightweight Polyurethane Breathing Tube L=735mm
XA007706584	BT-30	Self-adjustable Polyurethane Breathing Tube L=525-850mm
UU003085113	BT-40	Fixed length Heavy Duty Neoprene Breathing Tube L=840mm
XA007706527	BT-922	Breathing Tube Cover Polyethylene Clear - 1 per case (18) Breathing tube not included
70071564432	BT-926	Flame Resistant Breathing Tube Cover - 1 per case



**3M New Zealand Limited**

94 Apollo Drive  
Rosedale, Auckland 0632  
TechAssist Helpline: 0800 364 357  
Customer Services: 0800 252 627  
Email: [techassist@mmm.com](mailto:techassist@mmm.com)  
[3M.com/nz/ppesafety](http://3M.com/nz/ppesafety)



**3M Australia Pty Ltd**

Bld A, 1 Rivett Road  
North Ryde, NSW 2113  
TechAssist Helpline: 1800 024 464  
Customer Services: 1300 363 565  
Email: [techassist@mmm.com](mailto:techassist@mmm.com)  
[3M.com.au/ppesafety](http://3M.com.au/ppesafety)

**3M New Zealand Limited**

94 Apollo Drive  
Rosedale, Auckland 0632  
TechAssist Helpline: 0800 364 357  
Customer Services: 0800 252 627  
Email: [techassist@mmm.com](mailto:techassist@mmm.com)  
[3M.com/nz/ppesafety](http://3M.com/nz/ppesafety)