



EVOS SB7

Installation Manual - Australia

Contents

QUALIFICATIONS	3
PRODUCT SPECIFICATION	4
COMMUNICATION	4
COMPLIANCE	4
CONNECTOR	4
ELECTRICAL	4
ENVIRONMENTAL	4
LOGISTICS	4
PHYSICAL	4
INSTALLATION PREPARATION	5
ELECTRICAL SAFETY	5
IP 65 INGRESS PROTECTION	5
SUPPLY WIRING	5
1 PHASE INSTALLATION	5
INSTALLATION	6
TOOLS	6
LOCATION	6
COMPONENT GUIDE	7
INSTALLATION STEPS	7
1. REMOVE LID	7
2. MARK FIXING POINT	8
3. MOUNT STATION BASE	8
4. RE-INSTALL LID	9
5. REGISTER AND CONFIGURE	9
6. ELECTRICAL TESTS	10
7. POWER ON	10
8. TEST CHARGE	10
9. REMOVE PLASTIC FILM	10
USING SB7	11
CHARGER STATUS INFORMATION	12
WI-FI SETUP PROCESS	13
CHECKLIST	14

Qualifications

- ! The EVOS SB7 is designed to only be connected to a dedicated AC supply.
- ! The EVOS SB7 requires only Type A RCD + MCB upstream protection.
- ! The use of adapters or conversion adapters are not permitted with EVOS SB7.
- ! The use of cord extensions is not permitted with EVOS SB7.
- ! EVOS SB7 installation must be performed by a qualified electrician.
- ! EVOS SB7 must be installed according to local regulations (AS3000).
- ! Upstream power must be isolated before insertion or removal of the charging cable.
- ! Service / replacement must be performed by a qualified electrician.

Product Specification

Communication

Charging Mode	3
Protocol	OCPP1.6j
Wireless	Wi-Fi: 2.4GHz IEEE 802.11.b/g/n Bluetooth: 4.1

Compliance

Certification	CE Certified, CB Certification
Protection Class	I
Standards	IEC 61851-1, IEC 61851-21-2 EU RoHS Directive Compliant

Connector

Charging Cable length	5m (optional 6m)
Charging Connector Type	Type 2 (IEC 62196 Type 2)

Electrical

Charging Power	7.4kW at 230V
Connection Method	Permanently connected
Ground	PE Cable
Input power supply characteristics	EV supply equipment connected to AC supply network
Input voltage (L-N)	110 to 230 V AC
Maximum Output Current	32 Amps
Nominal AC Frequency	50 Hz / 60 Hz
Output power supply characteristics	AC EV supply equipment
Protection	6mA DC RCD - Only Type A RCD + MCB upstream protection required

Environmental

Access Condition	Unrestricted Access
Altitude	Up to 2000M
Impact Protection	IK08
Ingress Protection	IP65
Operating temperature	-25°C to +55°C
Relative humidity	Maximum 95% non-condensing

Logistics

Storage temperature	From -30°C to 85°C
Packing weight	3.85kg
Packing Dimensions (L x W x H)	385 x 385 x 100mm

Physical

Colour	Piano black
Dimensions (W circular x H)	320mm x 90mm
HMI	LED with dedicated apps
Mounting Height	Minimum 900mm from lowest edge to floor level
Mounting Type	Wall, Surface mount
Weight (including cable)	3.5kg

Installation Preparation

In the Box

7kW charging unit with attached type 2 charging cable, installation template, and adoption key.



SB7



Charge Cable

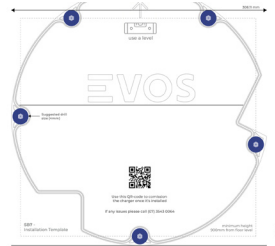

Installation Template

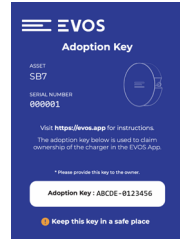

Adoption Key
*Please provide this to the owner.

Audience

The SB7 must be installed by a licensed electrician.

Electrical Safety

Upstream protection must be installed for safe operation.

Built In Protection	6mA DC RCD	
Required Upstream Protection	1 Phase Installation	<ol style="list-style-type: none"> 1. Only type A RCD (as per AS3000) Recommended 30mA Type A 2. MCB (as per AS3000) Recommended Type C MCB 40A

IP 65 – Ingress Protection

- Ingress protection for the SB7 must be maintained on installation of the input power cable.
- Use the correct cable gland for the size of supply cable, **hole size is M20**.

Supply Wiring

1 Phase Installation

Only one phase may be connected to L1 designation on input connector.

Neutral (N) and Protective earth (PE) must be connected to designation on input connector.

The phase voltage must measure ~230V to neutral.

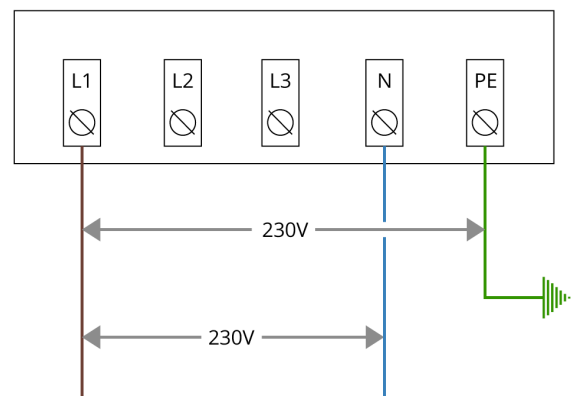

- ⚠ L2 or L3 designation on input connector cannot be used for SB7 installation.

Typical Installation Example

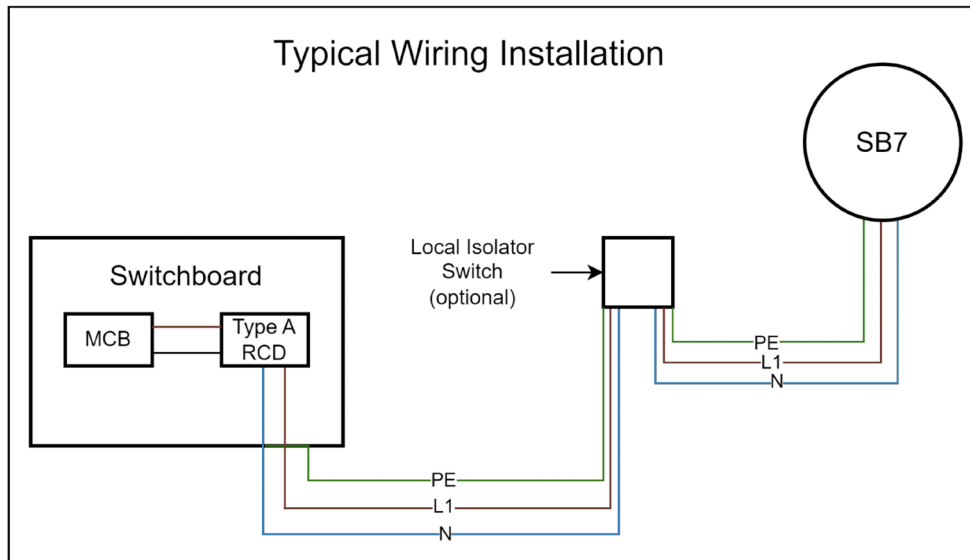

Installation

Tools

- 1 x Power Drill
- 1 x M5 Drill Bit
- 1 x Phillips Head Screw Bit
- 1 x 3mm Post Hex Security Bit
- 1 x ¼" Drive Ratchet
- 1 x 90mm Extension Bit
- 1 x Standard Electrical Test Equipment
- 1 x Level
- 1 x Mobile Phone or Laptop with Wi-Fi for Commissioning

Location

Before installation, check the preferred installation location has these features:

1. Easy access by driver
2. Easy stowage of charging cord (prevent wheel crush damage)
3. Easy to plug in vehicle without straining cable
4. Station is protected from vehicle damage
5. Station lower edge mounting height is minimum 900mm from floor level.
6. No obstructions to left and right of the charger.



Maximise Wi-Fi signal reception:

Avoid installing SB7 on opposite sides of concrete, masonry, metal studs, and other physical obstructions that could impede Wi-Fi signal reception.

Component Guide

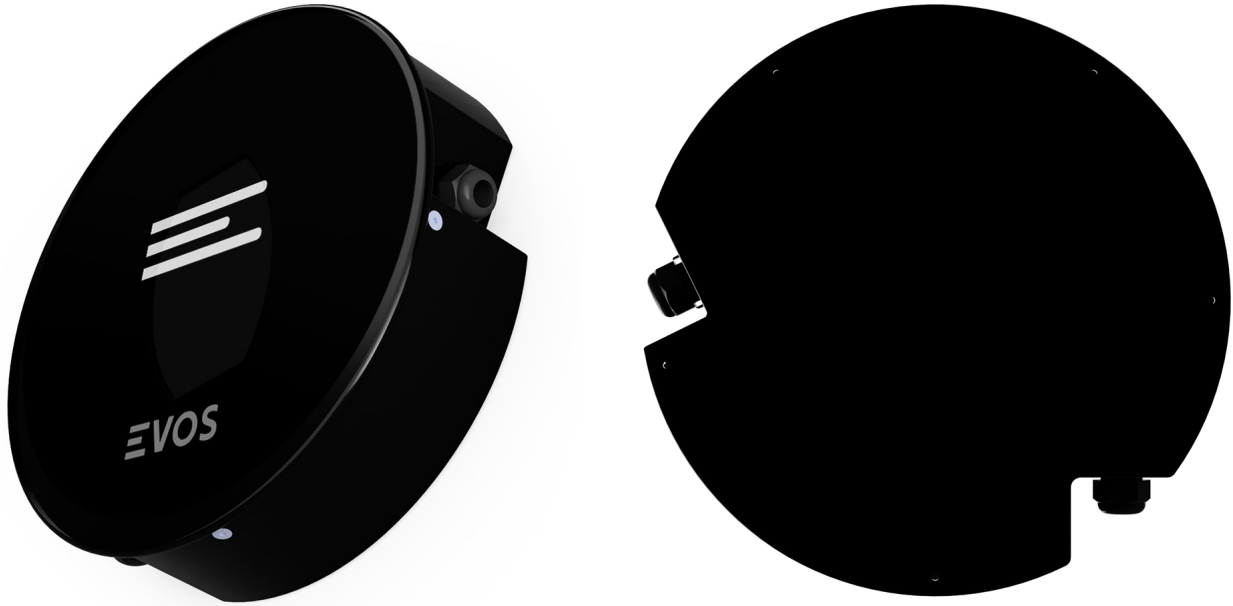

Charging Cable with Contact Type 2 Plug

Installation Steps

Please check off the items on the checklist located on the last page of this document

1. Remove lid

(1) Using a 3mm Post Hex Security Bit, remove the charger housing fasteners and place them aside carefully for re-installation.

(2) Remove the lid.

(3) Place on a flat surface (face up) where it will not be marked or damaged.

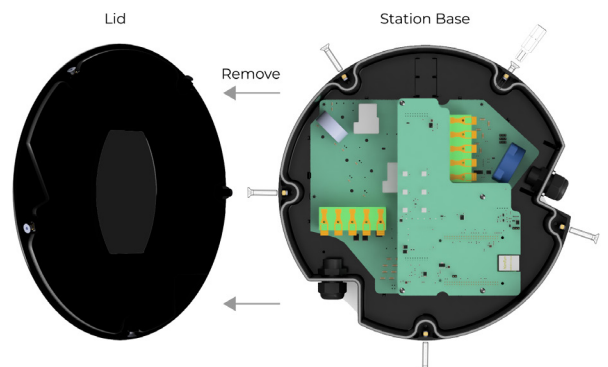

2. Mark fixing point

Use a level and the provided marking template to drill holes and to ensure that the charger is properly aligned.

- ❗ Minimum height of the lower edge is 900mm from floor level.
- ❗ Include a clearance around the sides of the SB7 of 300mm to allow access to all the lid screws on the SB7

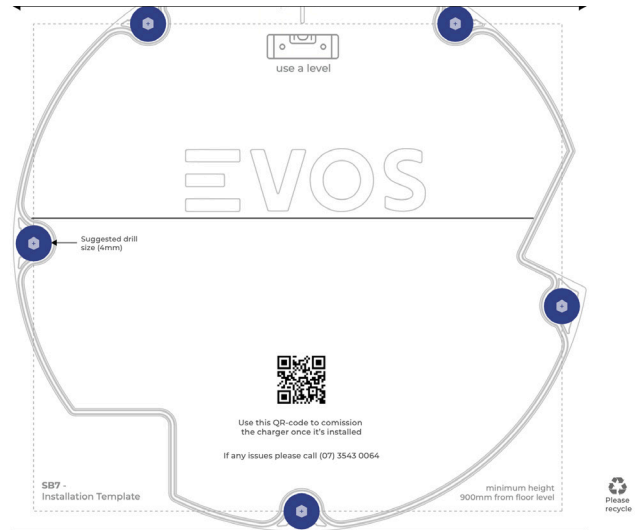

Installation template

3. Mount station base

Use fasteners to fix the station to mounting surface.

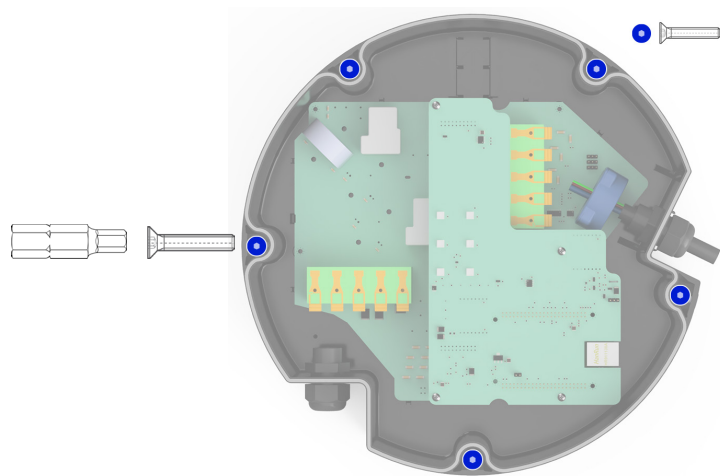

(Supply wiring diagram on Page 5)

4. Re-install lid

Use the charger housing fasteners and re-install the lid. Torque rating for lid M5 security screws 0.5 Nm.

Ensure the gasket is fitting correctly.

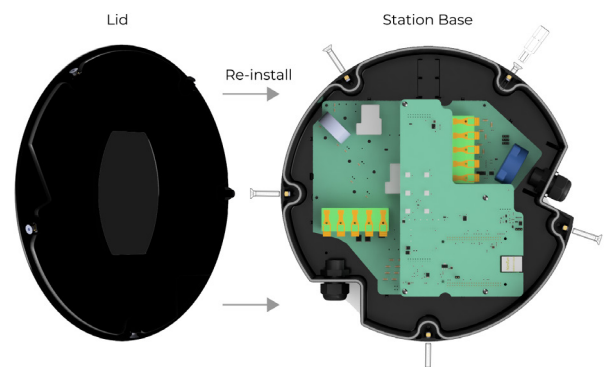

5. Register and configure (mandatory)

Connect to the EVOS App using the QR code on the base and register the charger. If the QR code does not work, enter this URL into a browser

<https://evos.app/c/<serial>>

Example

<https://evos.app/c/123456>



(1) If you have an installer account, please sign in, otherwise register an account.

Sign In

Enter your username and password, then click “Sign In” (1) to access the EVOS App.

Register

Click “Register” (2) to create a login for the EVOS App as an Installer.

Reset Password

Click “Forgot your password?” (3) to reset your password

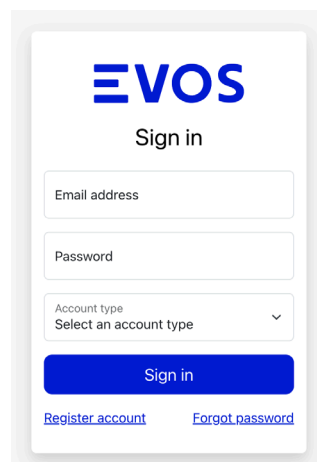
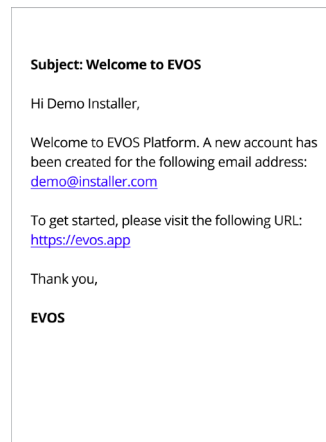
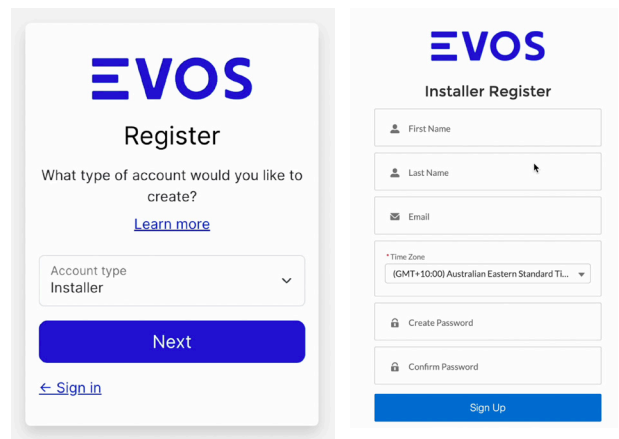

5. Register and configure (Mandatory)

Electrical License

At the install screen, please enter

1. Your electrical license number
2. Your electrical license type
3. Your electrical license expiration date
4. Which country is this license for
5. Which state or territory is this license for.

Commission Charger

At the install screen, please enter

1. The charger serial
2. The address where the station is installed.
3. The “Circuit Amperage Limit”.
This value represents the maximum continuous amperage the station may draw from the local circuit.
NOTE. The default circuit amperage limit is set to 32A. This value **MUST** be verified / adjusted by the installation electrician at the time of installation.
4. Owner’s email address. This will send an email to the owner of the charger to adopt it and configure the Wi-Fi network.
5. Take/upload 3 photos of the installation that show: The Charger, Compliance label, Residual-current device

The successful install screen will be displayed on configuration.

If unsuccessful, please call +61 7 3543 0064.

6. Electrical Tests

Inspect and verify installation meets local requirements before placing into service.

7. Power ON

Enable the upstream power

8. Test Charge

1. Connect a vehicle and perform a test charge.
2. Recommended to use a thermal camera to verify there are no hot spots on the input connector.

9. Remove plastic film

Remove plastic film from the lid.

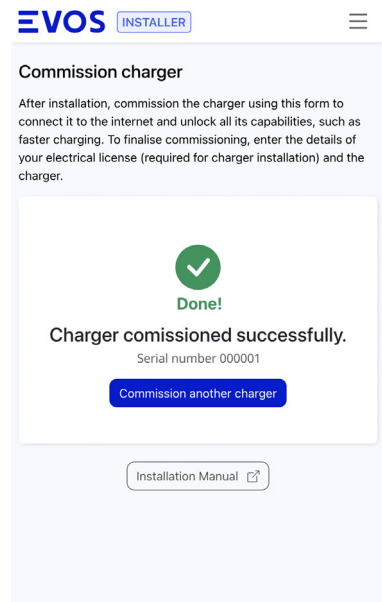
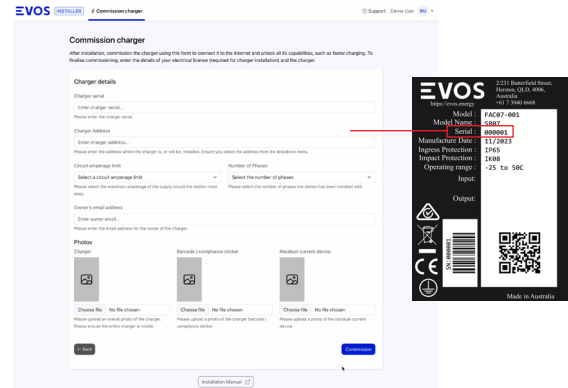
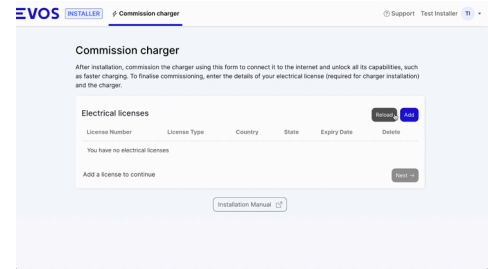

Using SB7

Charging a Vehicle

1. Check EVOS SB7 status LED is White.
2. Follow vehicle preparation instructions for starting a charging session (unlock inlet / open door / remove inlet cover).
3. Remove the protective cap from the plug.
4. Check the charging cable for damage and the plug for damage or contamination.
5. Insert the plug into the vehicle inlet. Check the plug is fully inserted.
6. The vehicle inlet will lock the plug.
7. Start of charging session
 - SB7 status LED
 - a. Blue – Charging
 - b. Blue Slow Pulse – Waiting Authentication
 - c. Green, Off Pulse – Vehicle not ready
8. When the charging session ends, follow the vehicle instructions to unlock the vehicle inlet.
9. Remove the plug from the vehicle inlet.
 - Never use force to remove the plug.
10. Loop the cable once anti-clockwise around the shield and replace the plug's protective cap immediately.
11. Check SB7 status LED is White.
12. Follow vehicle instructions after charging session (install covers / close door).

Charger Status Information

The LEDs on the EVOS SB7 convey the state of the station as listed below.



White
Charger is ready for charge.



Blue Slow Pulse
Charger waiting for authentication. Press 'Start Charge' to begin charging.



Blue
Charger is charging.



Red
Charger is faulted.



Red Slow Pulse
Charger is unavailable.



Green, Off Pulse
Vehicle not ready. Check vehicle for more details.



Cyan, White Pulse
Charger is not connected to Internet.



Green, White Pulse
Unplug charging cable and plug again.



Red, Purple, White, Green
Charger is rebooting from a hard reset.



Purple, Cyan Pulse
Downloading.



Blue Quick Flashing
Charger is suspending.



White with Loading Spinner
EVOS App is sending a start, pause or resume command to the charger. (EVOS App)

Wi-Fi Setup process

1) Register a new MyEVOS account and adopt an SB7 charger

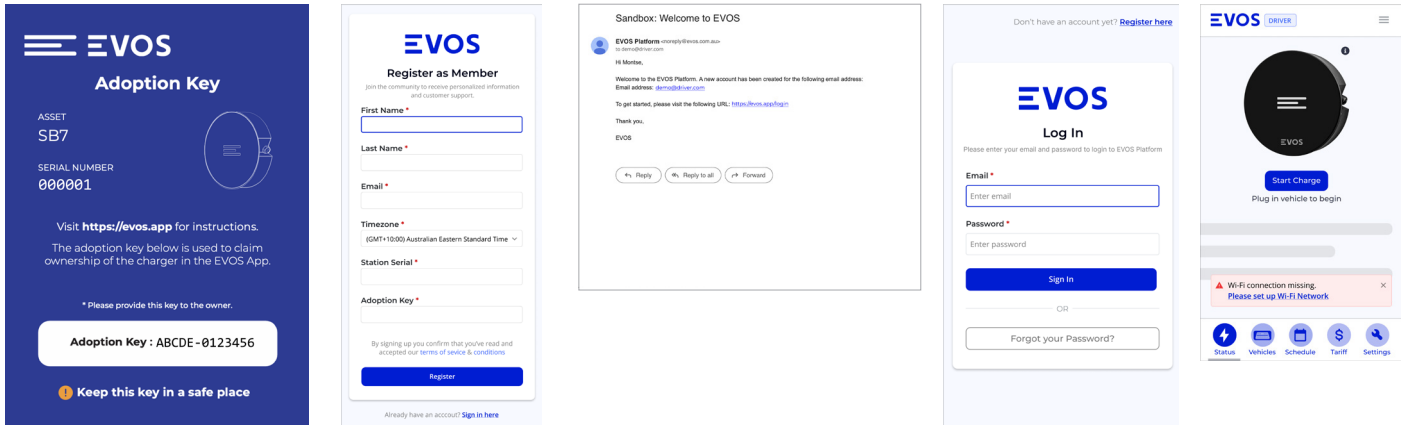

2) Set up Wi-Fi using your Home Wi-Fi credentials

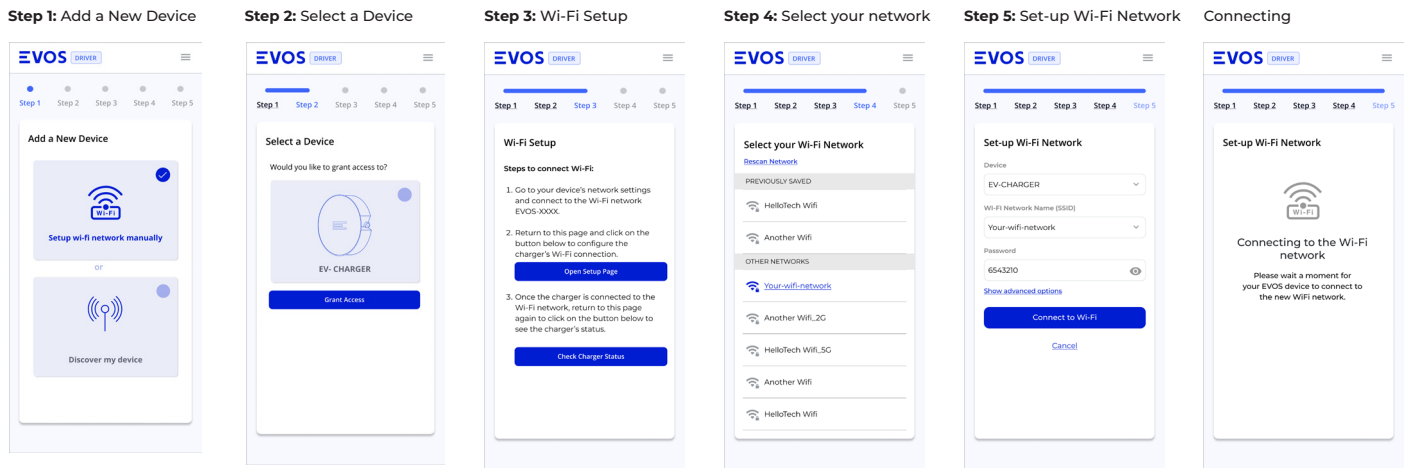

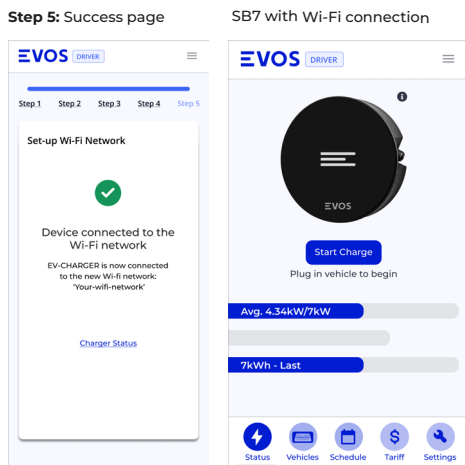

3) Your SB7 is now connected to Wi-Fi and you can unlock all its capabilities.



Wi-Fi connection missing. Please set up Wi-Fi Network

If your charger didn't connect successfully to the Wi-Fi, the App will show this alert, also the charger will blink with a white and cyan light. Please check your Wi-Fi is enabled, the credentials are correct, and try again from Step 1.

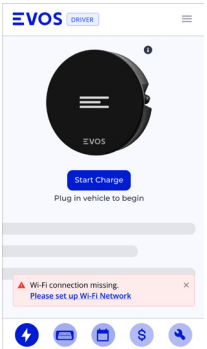
White, Cyan Pulse
Charger is not connected to Wi-Fi.

EVOS Support

If you require support during your installation, we're happy to help.
 Please call +61 7 3543 0064.
 For general email enquiries, sayhi@evos.com.au

Checklist

Please use this checklist to ensure the station has been installed safely.

Item	Yes	No	Comment
SB7 and charging cable are not damaged			
Station mounting position is easy to access			
Station mounting position is protected from vehicle damage			
Station lower edge above 900mm above ground level			
Upstream type A RCD installed			
Upstream type C MCB installed			
Station base is mounted securely to surface			
Circuit amperage limit has been set			
Station mounting position is near to Wi-Fi network modem			