

# öko skin hidden fix



Patricia Reser Center for the Arts, Beaverton, USA, opsis architecture

Installation instruction  
concealed fastening system

# Refined mounting system öko skin hidden fix

The newly developed concealed fastening system hidden fix for öko skin facade slats enables quick and easy installation. With the concealed attachment, the öko skin slats are even more effective, since the overall appearance is not marred by rivets or screws. Rieder supplies all fastening components

as well as the öko skin slats. These are delivered to the site already pre-drilled, whereby the installation effort is reduced. Rieder provides a calculation tool to calculate the exact number of required components.

## All advantages:

- Reduced drilling effort by using only 3 instead of 5 fastening clips.
- Reduced installation effort due to fewer clips, with a universally compatible clip available with various fasteners (RPA, other fasteners upon request).
- Simplified, optimized substructure (on the customer side) from a double-layered to a single-layered system resulting in a 30% reduction in this scope of work.
- Consequently, reduced installation effort.
- 15% less labor involved compared to the hidden fix system.
- Overall cost savings for the entire system.

## Components

The matched components are sold as complete packaging units. An öko skin hidden fix set consists of 100 clips, 500 Rieder Power Anchors (RPA) and 100 screws. For a öko skin pallet, 6-8 complete sets are needed. The respective packaging units are shown in the price list.

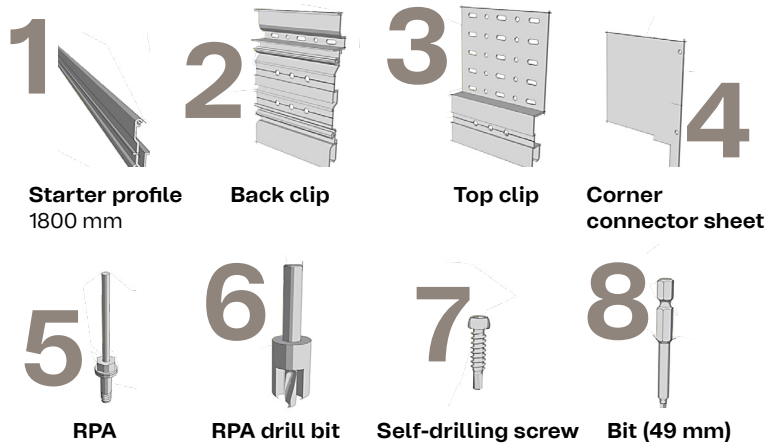

## Cover types & laying pattern

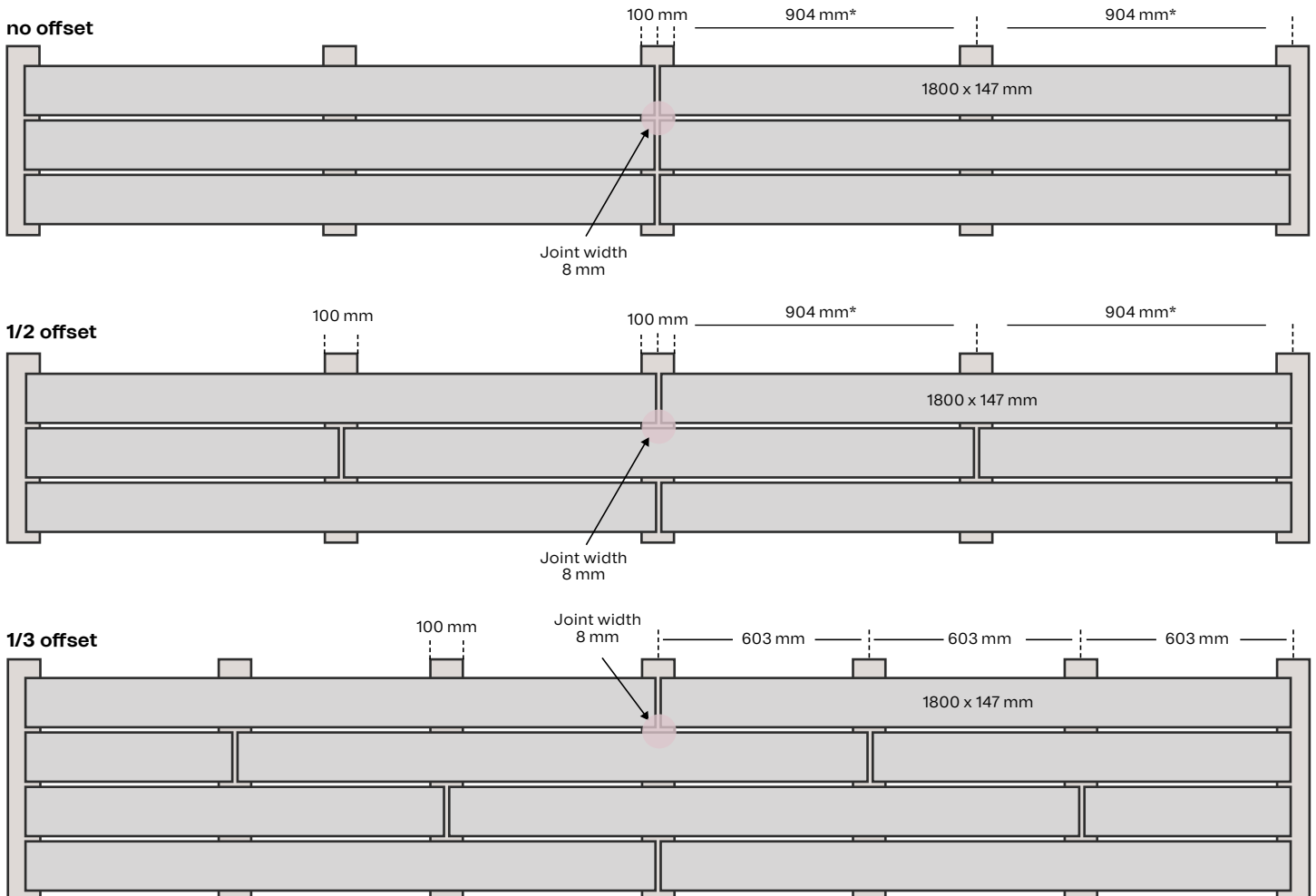

\*The fastening distances or the number of clips must be verified project-specifically through a static calculation.

# Preparation of the substructure: Rule 155

**HAT PROFILE AT  
LEAST 100 MM WIDE!**

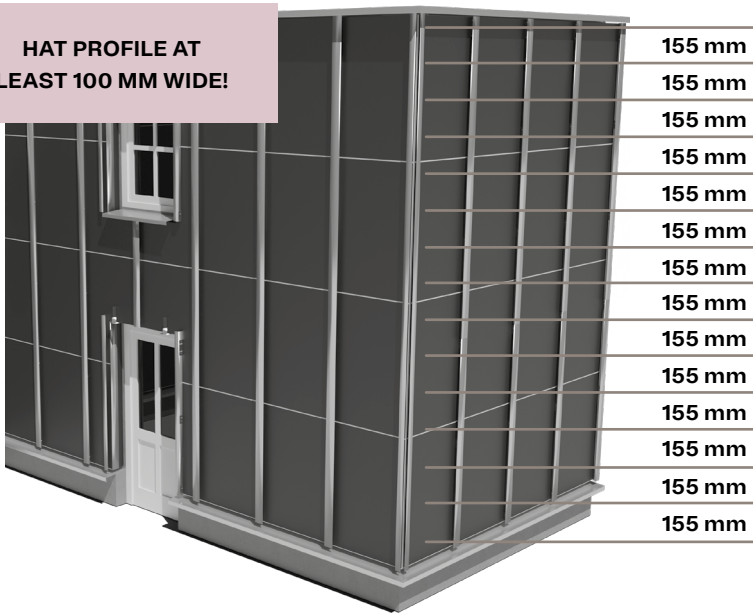

ökoskin hidden fix is suitable for ventilated facades.

If wall brackets, mounting brackets (horizontal), insulation and hat profiles (made of aluminium or similar profiles made of wood or steel) have been installed, you may start by installing the starter profile at the bottom edge of the facade surface.

The slats are mounted from bottom to top. The computation helps to calculate the optimal height of the starter profile

$$155 \text{ mm} = \text{slat height } 147 \text{ mm} + \text{joint } 8 \text{ mm}$$

The starting point is measured from the top of any window, door or building in 155 mm increments.

This ensures that an entire slat can be mounted above the window or door.

**Standard details such as window soffits, skirting boards, parapets etc. at [www.rieder.cc](http://www.rieder.cc)**

## Rivet the clip onto the öko skin

On request and for easy processing on the building site, the öko skin slats are pre-drilled. These holes are suitable for all 3 cover types/laying patterns.

First, place the back clips on the slats and rivet them with the RPA (with the appropriate riveting tool, e.g. GESIPA AccuBird® Pro). The stop edge of the clips facilitates accurate positioning.

Rivets may be used with no pressure on the RPA. The RPAs should rest precisely on the rubber disc. If the rivets are too tight, or there is dirt or dust in the drill hole, the slat can hollow out at the front.

If an RPA is incorrectly set, a new hole with a minimum distance of 30 mm must be drilled in the slat. The same blind hole must not be used a second time. The clip must be shifted accordingly.

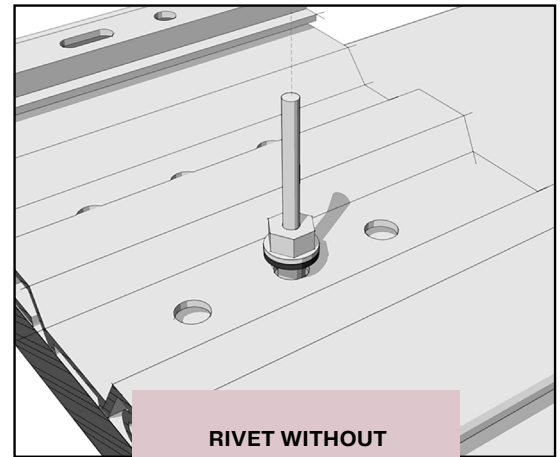

### Drilling pattern pre-drilled holes 1/2 offset / no offset

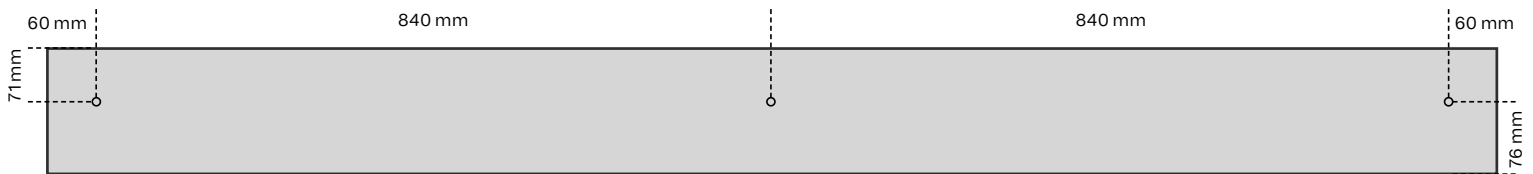

### Mounting position for 1/3 offset



### Mounting position for 1/2 offset / no offset

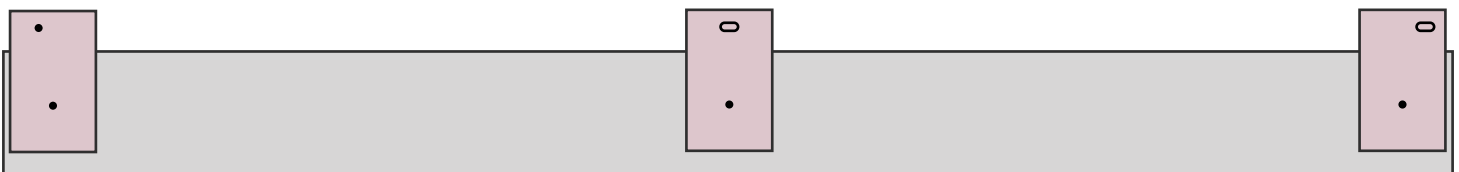

The position of securing the clips with self-drilling holes should be observed as depicted.

# Cutting

When cutting the slats, the side of the slat must face upwards so that the cut edges do not break and appear clean.

**Trimmed slats must be at least 200 mm long.**

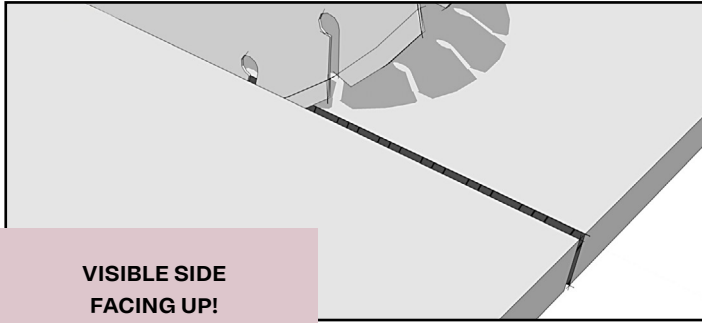

**VISIBLE SIDE  
FACING UP!**

# Drilling

If slats are trimmed on site, new holes must be drilled (60 mm min. distance to edge). For this purpose, position the back clip and use it as a drilling jig. Then, the hole is drilled without a clip to the depth stop of the drill. The drilling dust must be removed from the blind hole.

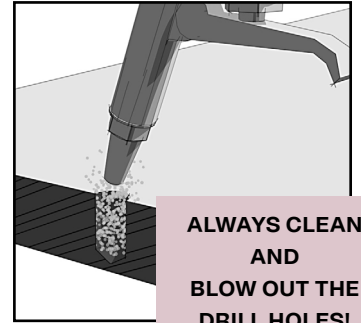
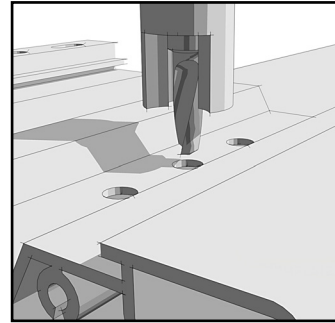

**ALWAYS CLEAN  
AND  
BLOW OUT THE  
DRILL HOLES!**

# Installation of starter profiles

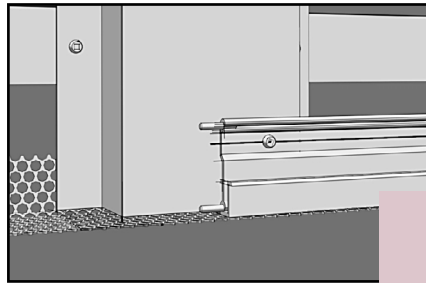

**Starter profile**  
Length 1800 mm  
incl. two connecting bolts

**ONLY ONE FIXED  
POINT PER PROFILE!**

First fixing of the profile with drilling screw (fixed point). For further attachment points (floating points), the profile must be pre-drilled (diam. 4.5 mm). For a profile joint (min. 3 mm), the thermal expansion is ensured via the connecting bolts. The starter profile must be mounted horizontally and start at the same height everywhere.

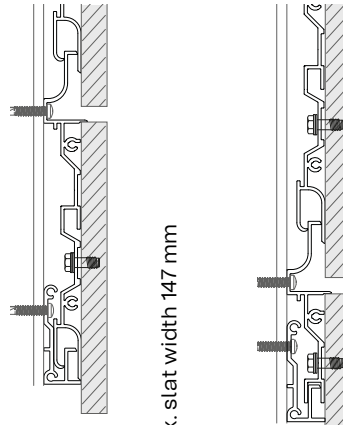

max. slat width 147 mm

min. slat width 73 mm

For the starter profile, the slat can be narrowed in width by half. In this case, the slat must be re-drilled and the back clip shortened on the marking line.

**Rule 155 not applicable!**  
x \* 155 + min. 73 mm

# Installation of clips

The slats with the back clips are placed in the underlying clips; using the 8 mm spacers a uniform joint pattern is ensured. The clips are screwed to the hat profile using a self-tapping screw.

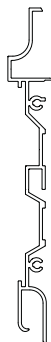
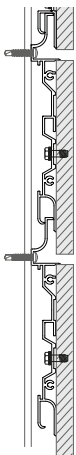

**Clip**  
Width 110 mm  
Height 165 mm

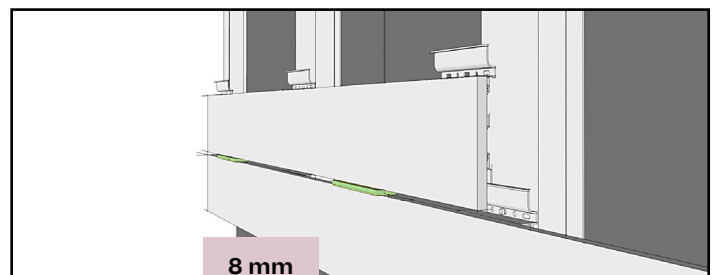
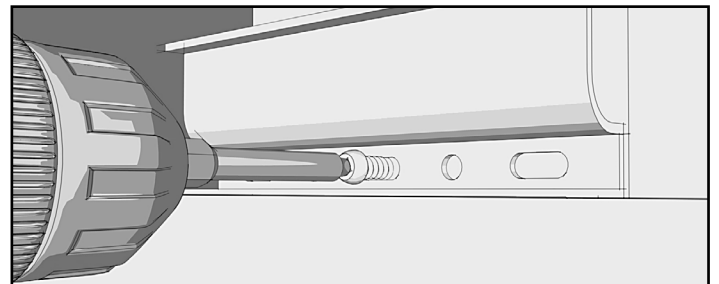

**8 mm**

**ONLY ONE  
FIXED POINT CLIP  
PER SLAT!**

Only one clip per slat is screwed through a round hole (fixed point). The remainder is fixed with the oblong holes (floating points).



The fixed point clip should always be in the same place for each slat.

Fixed-point clip

Floating-point clip

Fixed-point clip

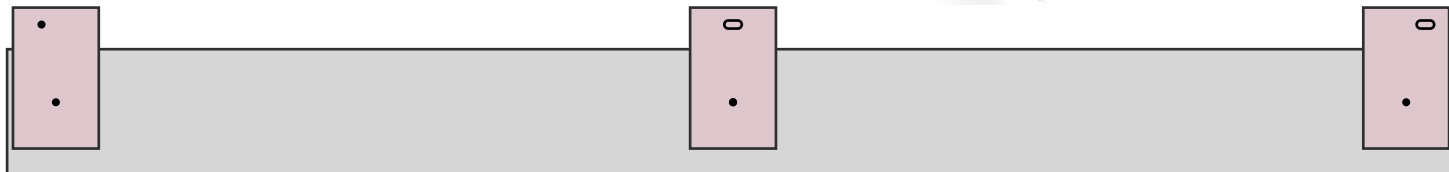

## Installation of corner connection sheets

1. The corner connector sheet is pushed into the outermost clip.
2. Subsequently, the slat is bolted to the front end of the clip of the staggered slat.

A corner connector sheet is used for the edges. This serves to cover and fix the back clips. The corner connector sheet may be used alternately on the left and right edges (or only on one side only). Thus, the creation of a corner with interlocked or continuous joints is possible.

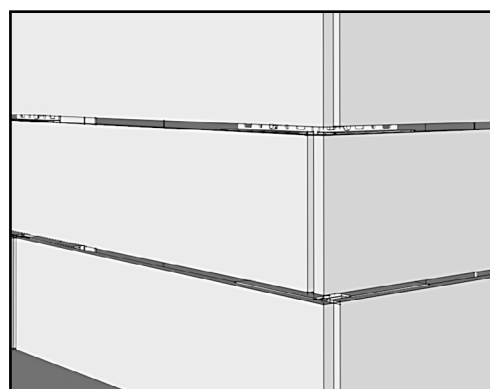
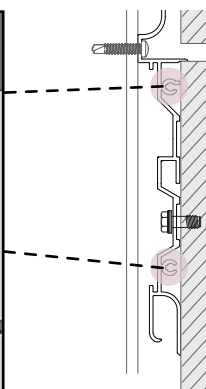
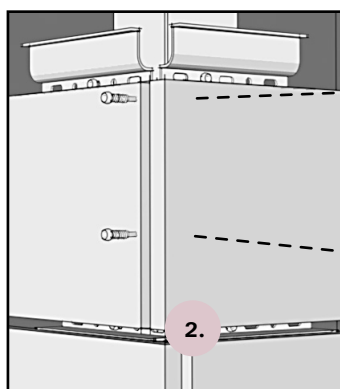
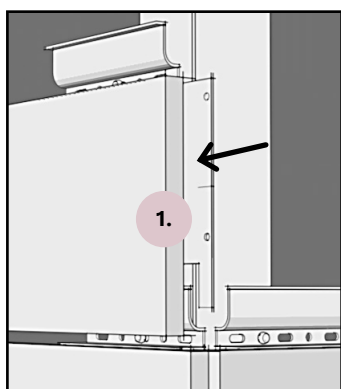

## Installation of top clips

With the top clip, the slat can be narrowed in width by up to half. In this case, the slat must be re-drilled. Instead of the top clip, a back clip may be used.

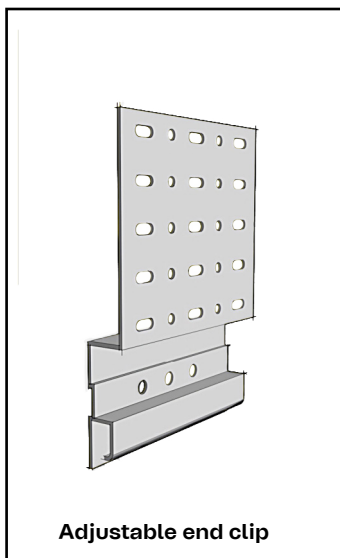
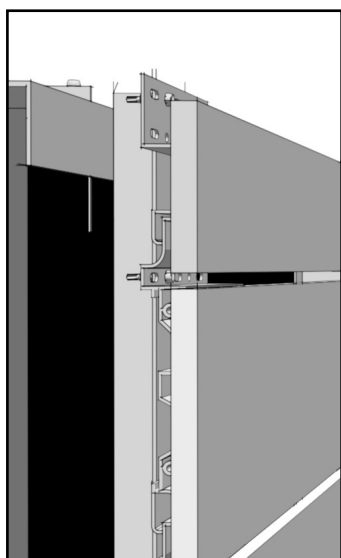

**Truncated  
Fastening Clip**  
(See details on the  
next page)

**End-Clip**

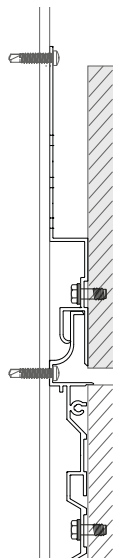

max. slat width 147 mm

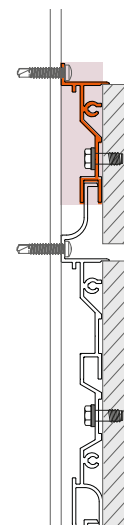

exact slat width 74 mm

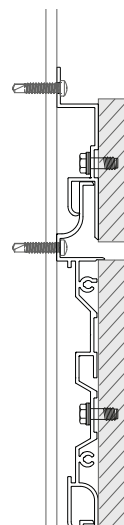

min. slat width 65 mm

# Installation fitted slats

## with trimmed back clips

In order to ensure flexibility in the design of the facade, narrower slats can also be used for connections at the bottom, at the top and in doors and windows. For this purpose, the back clip may be shortened at the points marked with a line.

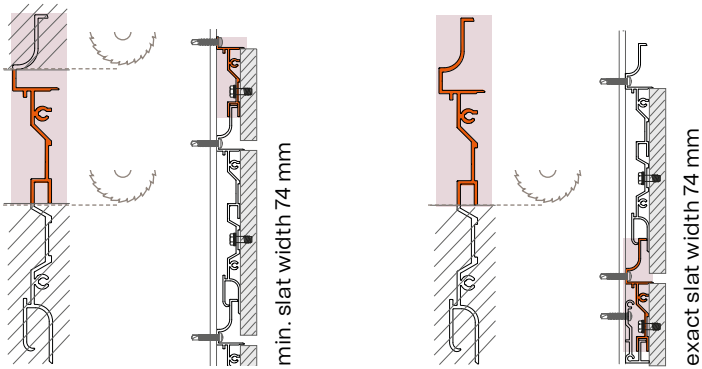

# Replacement of öko skin slats

Individual damaged slats may easily be replaced by the specified joint height of 8 mm, even in the middle of the field. To do this, loosen the screws on all back clips of the slat and slightly push the slat up and lift it out downwards. To replace the bottom slat, the slat above needs to be removed.

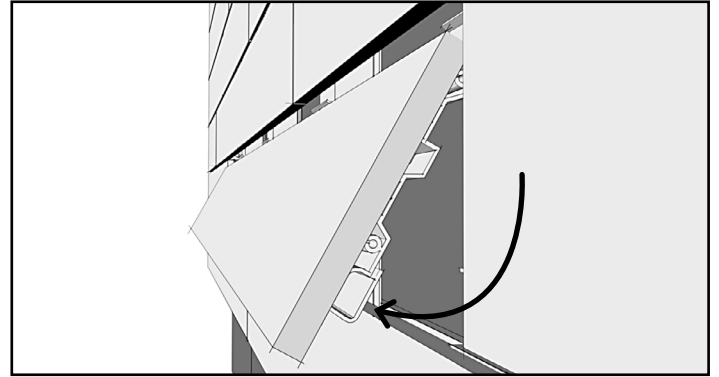

# Vertical installation

For vertical installation, the supporting structure is rotated by 90°. The hat profile is thus mounted horizontally. The fixed point clip requires 4 fixed points. 2 fixed points are mounted to the slat by means of RPA. The other two points are screwed to the hat profile with self-drilling screws. A hole for fixing the clip to the slat must be drilled at the building site (offset position). For the corners, a side clip is required instead of the top clip.

4 fixed points for fixed point clip

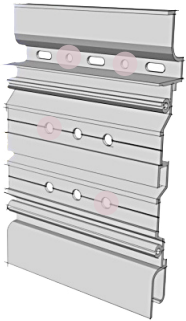

Side clip

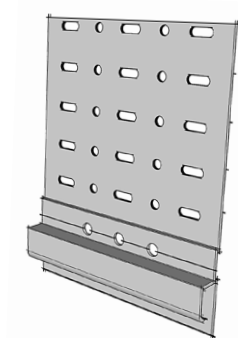

Corner solution 1 with starter profiles

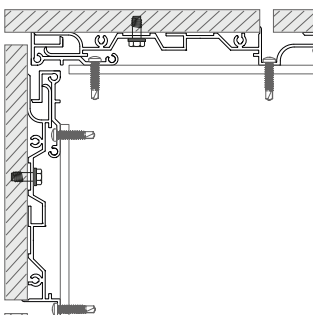

Corner solution 2 with starter profile and variable side clip

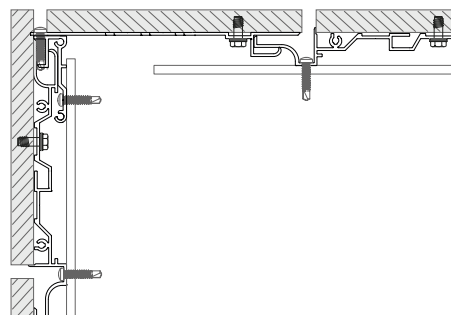

no offset & 1/3 offset

Fixed point clip

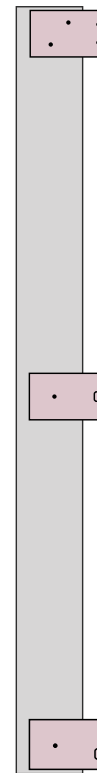

1/2 offset

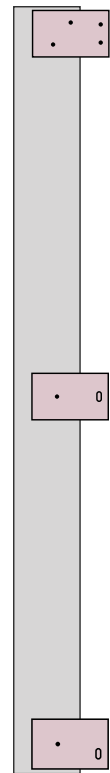

With the side clip, the width of the slat can be narrowed by up to a half. In this case the slat must be re-drilled.

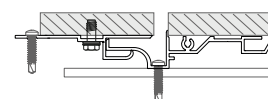

# Handling instructions

## Loading

Safe, form-fit loading. No more than 4 pallets of the same size may be stacked on top of each other. Do not place larger pallets on top of smaller ones. Do not stack other goods on top of the pallets. The slats must not be stepped on. For container loading, we refer you to the "container information sheet".

## Edge protection

Safe transport calls for robust edge protection. The number of lashing straps must comply with legal requirements. Load safety must be ensured.

## Proper unloading

A forklift and/or crane must be used for unloading. A standard pallet loaded with 38.1 m<sup>2</sup> öko skin weighs 1.2 tonnes. It is recommended that you use a forklift with 4 tines and fork spacing of 2300 mm or a lifting traverse for crane unloading for special öko skin lengths, e.g. pallet length of 3700 mm. If a forklift with 4 tines is not available, the pallet must be placed on a steel frame so that it can be transported on site.

Pallet deflection can cause surface cracks and even slat breakage. Observe load carrying spacing! Avoid pallet vibration during handling. Pick up pallets individually - do not stack them on top of each other or place them on the edge of the lower pallet. Drive slowly!

## Storage area

When dealing with large projects in particular, we recommend that the plan allows for a suitable (dry and level) storage area for the slats, such as in an underground car park, hall etc. Make sure the slats are placed on level ground! Pallets must not be stacked on the building site.

## Protection when stacking slats on top of each other

Slats must not be stacked on top of each other without sufficient protection between them. Glassfibre reinforced concrete elements, pieces of wood or other materials may not be placed between the slats. The layer pads must be large enough to cover the whole surface. To protect against damage caused by the slats rubbing against each other, a foam foil layer pad must be placed on each slat.

## Weatherproofing

The slats must be stowed safely and be well protected indoors or under a roof until just before installation. They must be suitably protected against moisture. The slats must stay in their packaging until immediately before installation. If they are stored outdoors for short periods, the pallet packaging must be opened to prevent condensation water. The slats must be fully covered with a suitable construction foil. The öko skin packaging film does not provide sufficient weather protection.

## Professional handling of the öko skin slats

Clean white protective gloves and appropriate protective equipment must be worn. Do not push or pull slats from the stack. Slats must not rub against each other. To turn them, always turn onto the length side and carry the horizontal slat standing on the length side. Avoid deflection and vibration, as this causes surface cracks and even slat breakage. Do not allow slats to rest on their edges or put them down without appropriate protection (e.g. polystyrene, Styrodur or carpet). Vertically leaning the slats against a wall can cause them to deflect and crack.

## Work area

Create a dry working environment and a suitable work surface (trestles or work table with support) for precise working at working height; if it rains, put up a pavilion or assembly tent to ensure dry working conditions. Only put marks on areas of the slats that will be cut off, as you may not be able to remove them.

## Cutting the öko skin slats - dry cut

Precise cut-outs, bevel cuts and mitre cuts must be made with a hand-held circular saw, guide rail (e.g. Festool plunge saw TS 55

EBQ-Plus-FS or equivalent) and splinter protection. The exposed side of the slat points upwards. Diamond saw blade for hand-held circular saw (e.g. Focus "Sprint" or equivalent, Ø 150 mm, hole diameter 22.5 mm, spacing ring to 20 mm).

## Blind hole drilling

The drilling is normally done in the factory. If additional drilling is required on the building site, this must be carried out using approved system components and equipment. The manufacturer's drilling guidelines must be observed. Make sure that the entire surface of the slat rests on a clean surface with the exposed side facing down and with a layer pad such as carpet. Use a compressor to remove (blow out) the drilling dust from the borehole.

## Required equipment

Cordless screwdriver or drill - no impact drill.

## Assembly

Separable spacers (wedges) prevent the joints from bursting out.

## Cleaning the öko skin slats prior to assembly

Place the slats at an angle during cleaning. Clean them under running water with a non-scratch brush or a microfibre cloth. After drying, observe storage guidelines. There must be no traces of standing water left on the slats.

## Cleaning interval after installation

Depending on the location of the building project and how dirty the facade is, we recommend that the facade is professionally cleaned at intervals of approx. 2 - 5 years. The recommended cleaning intervals are guidelines. Prior to any cleaning being carried out, each facade should be inspected to ensure it needs to be cleaned.

## Cleaning systems

For normal soiling, we recommend the MC-Duroprop B system from Firma MC - Bauchemie ([www.mc-bauchemie.de](http://www.mc-bauchemie.de)) or equivalent.

Please note: Because of its high dissolving power it can damage the surface protection if used incorrectly. MC-Bauchemie's usage instructions for the cleaning systems must be observed. We recommend thoroughly cleaning the facade after the assembly work.

## No chemicals

Do not use chemicals (except fibreC cleaner).

## No high-pressure cleaners

Do not use steam jets or high pressure cleaners. High pressure water jets leave streaks on the facade.

## Correct handling

All workers must receive instructions based on the handling guidelines prior to starting their work.

## Retain your documents

Retain package information inserts: handling guidelines, packing list and pallet labelling.

## Documentation

Inspection on receipt of goods. Transport damage must be noted in the transport documents and countersigned by the driver.

## Document defects

Defects must be documented with photo and report, and immediately reported in writing (complaint). Defective goods must not be installed under any circumstances!

**Please note:**

All visualisations shown in the installation instruction are schematic representations of the system.  
Constructional requirements and specifications and project-related details are not taken into account.

**Rieder Smart Elements GmbH & Co KG**

Glemmerstraße 21  
5751 Maishofen, Austria

+43 6542 690 844  
office@rieder.cc  
www.rieder.cc