

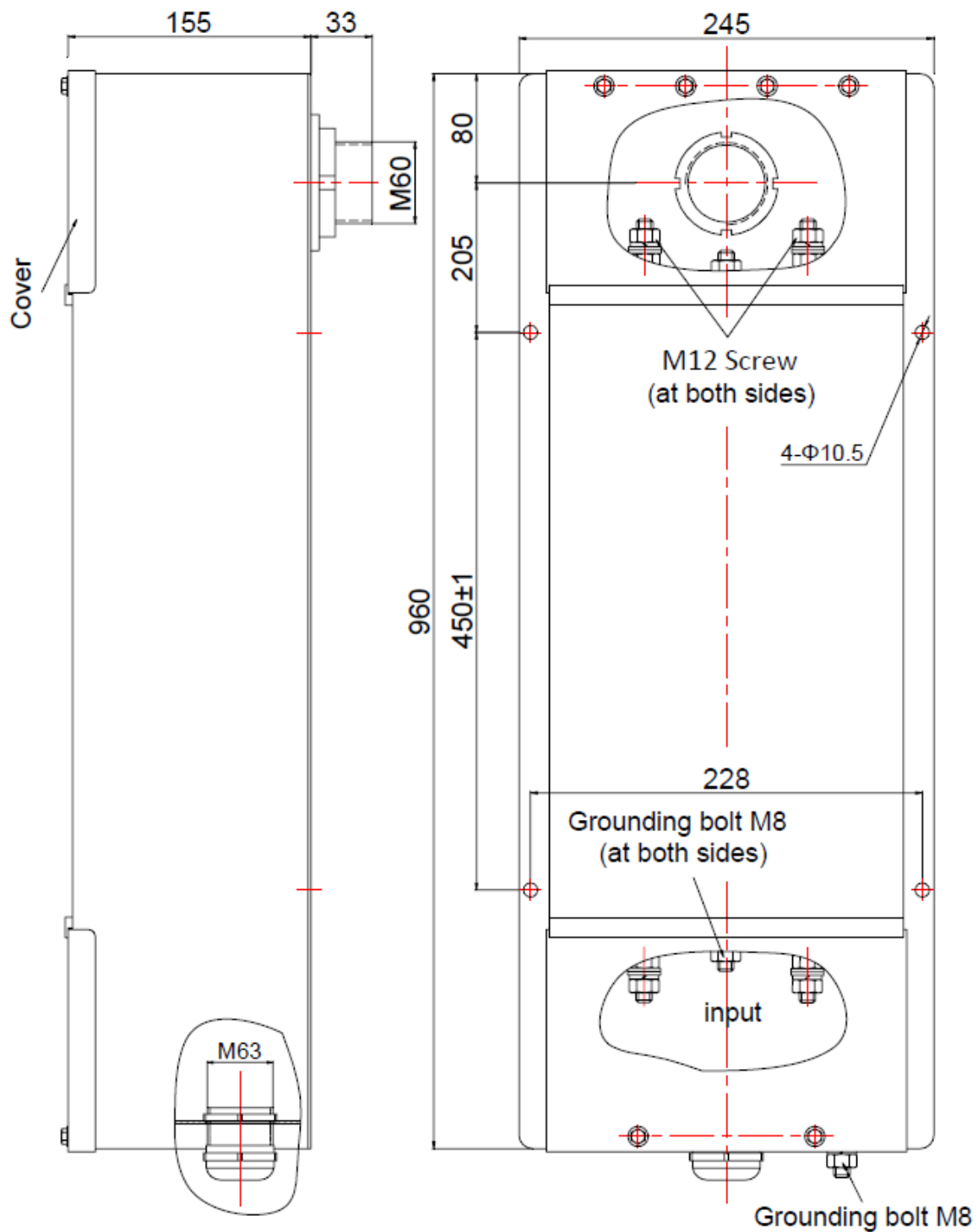

U86C2x200

Power Line EMI Filter

1. Dimensions (mm)





2. Specifications

Rated Voltage	277VAC/500VDC
Operating Frequency	0-60Hz
Rated Current	2x200A
Shielding Effectiveness	100dB, 14kHz-40GHz
Climatic Category	25/070/21
Hipot Test	1200VDC, 2 SEC

3. Typical Applications

EMC Anechoic Chambers

4. Installation Diagram

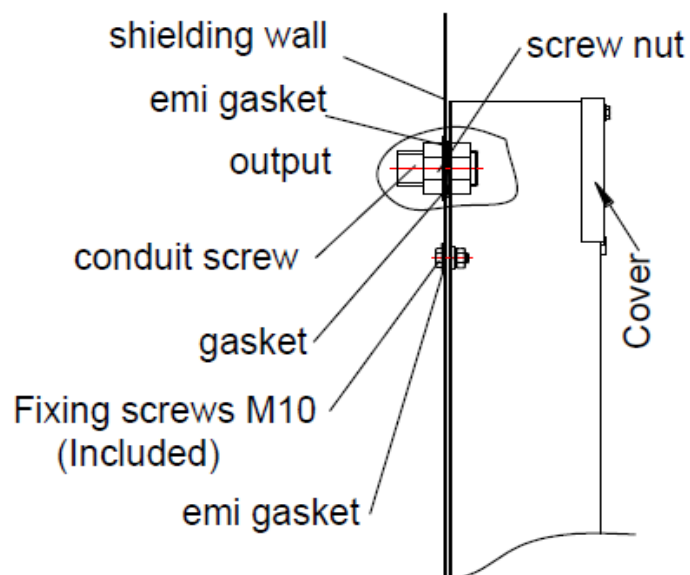



5. Accessories List

- ① M60 Conduit Screw: 1pc
- ② Gasket 60: 1pc
- ③ M60 Screw Nut: 1pc
- ④ EMI Gasket 60: 1pc
- ⑤ Certificate: 1pc
- ⑥ Cable Gland M63: 1pc