

GROOVE
DESIGNS

INTERIOR PRESENTATION

MR.KALYAN RAJU
(VIJAYAWADA)

FLOOR PLAN



FLOOR PLAN

FLOOR PLAN

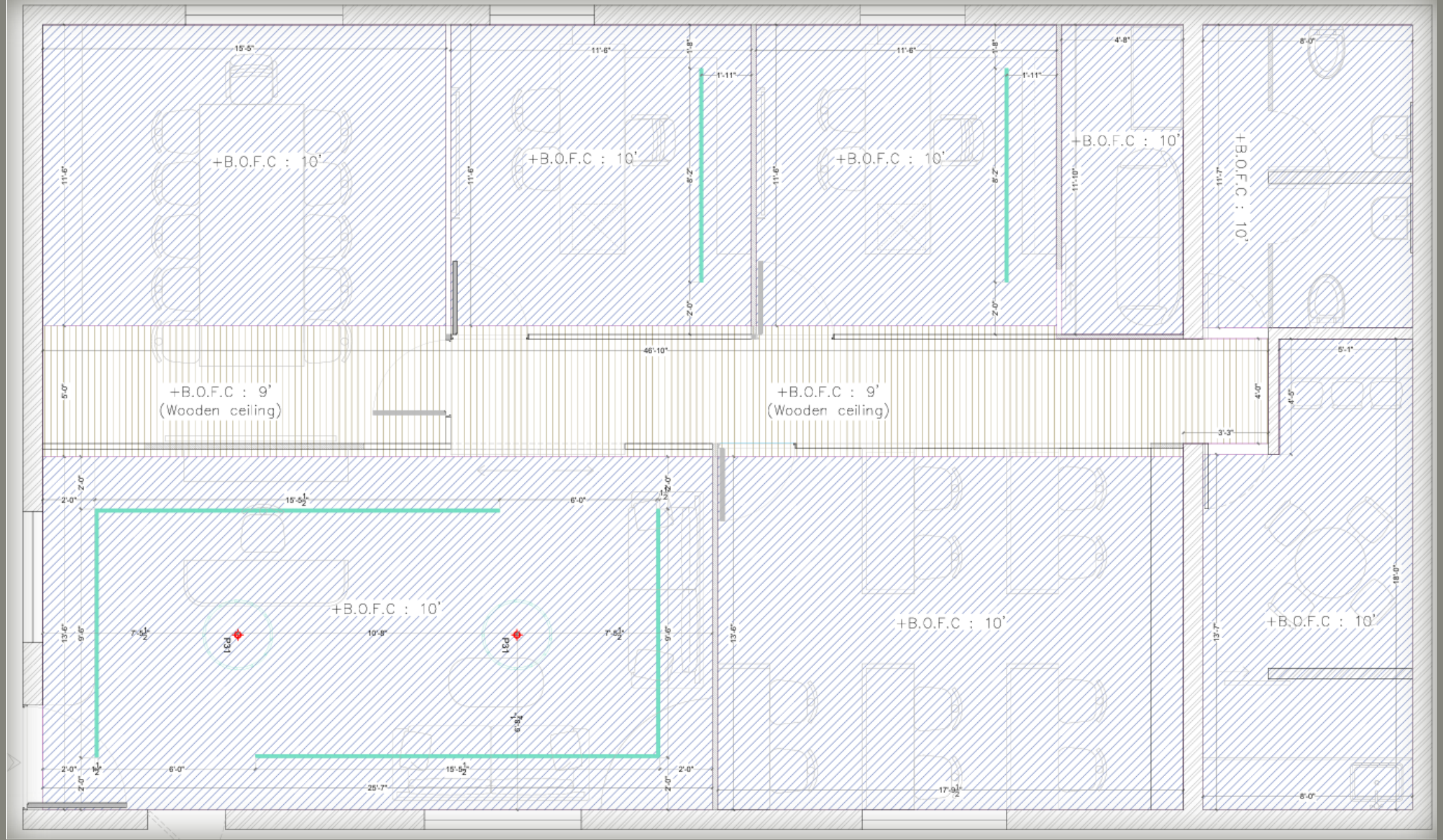

CEILING LAYOUT

RECEPTION & WAITING AREA

RECEPTION AREA

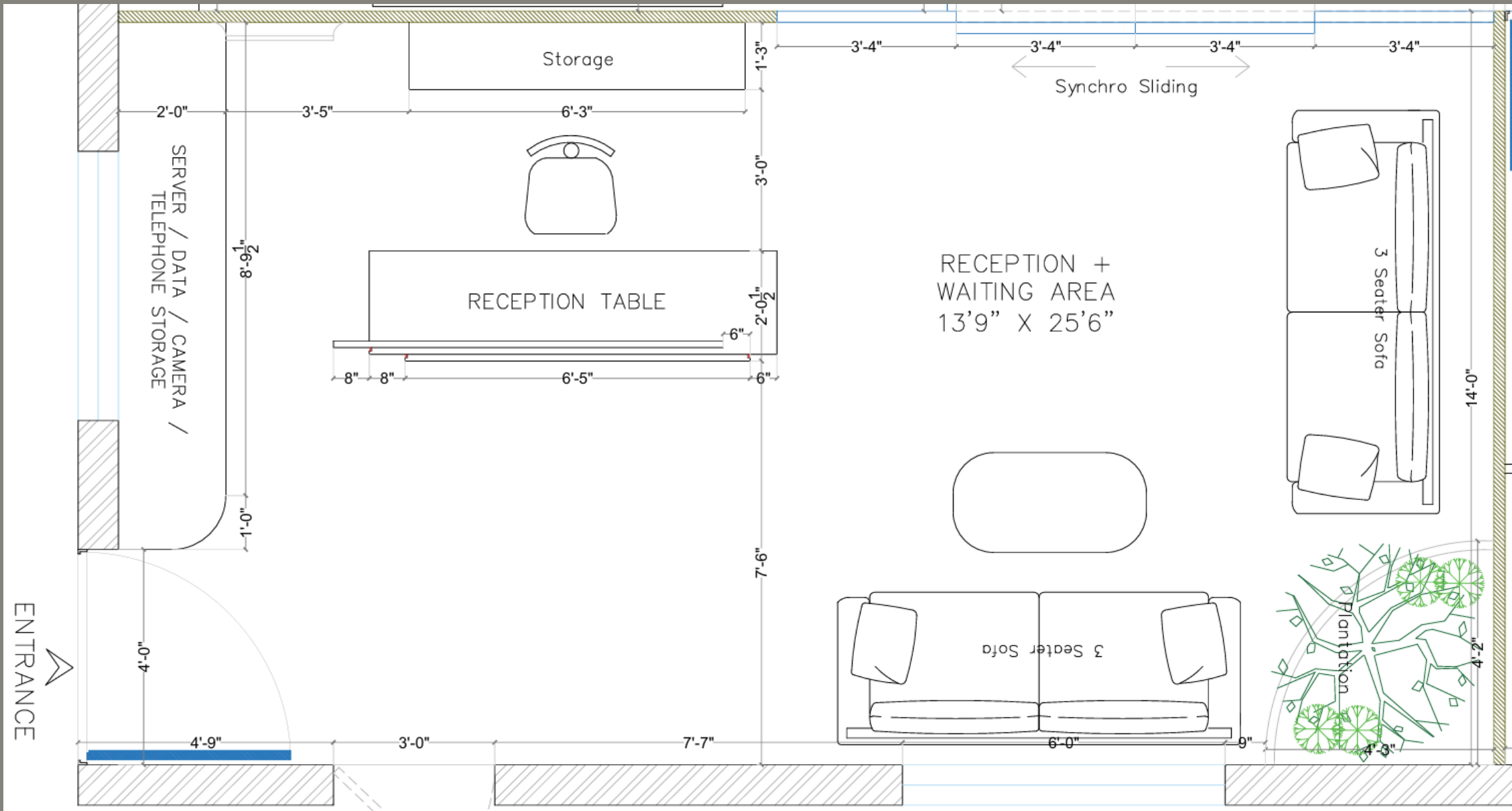

PLAN

RECEPTION AREA

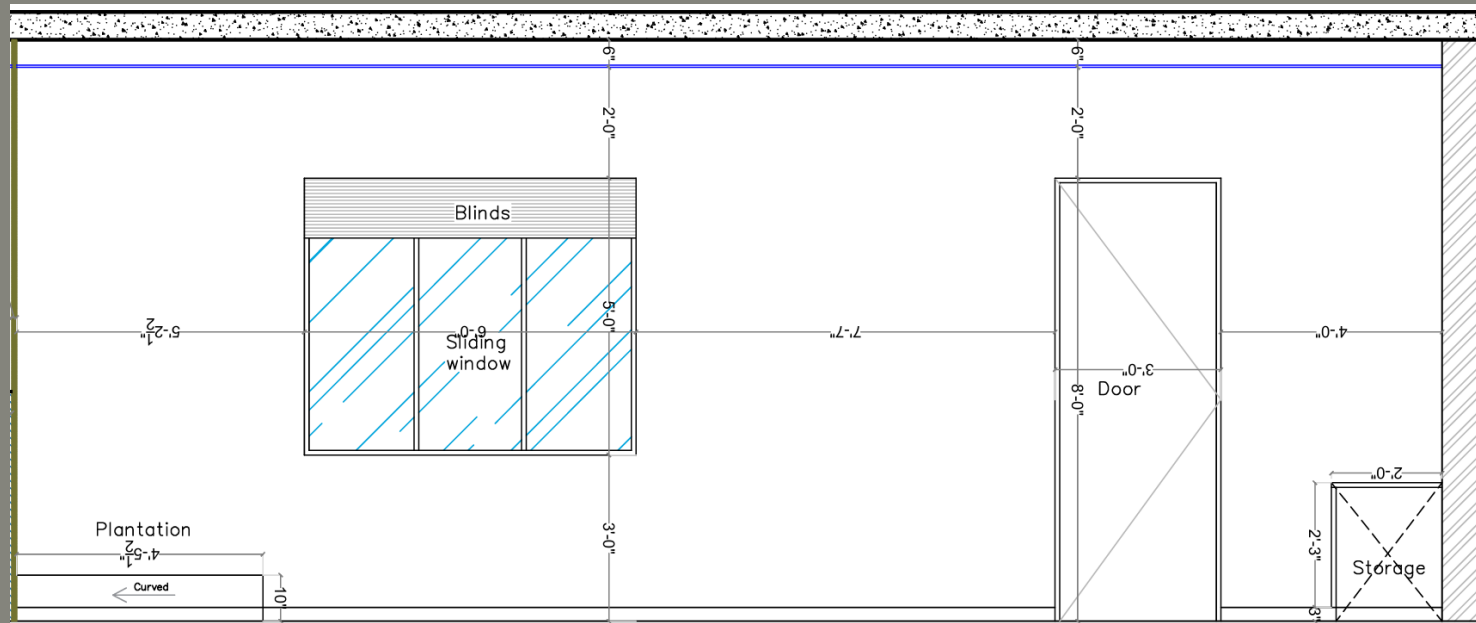
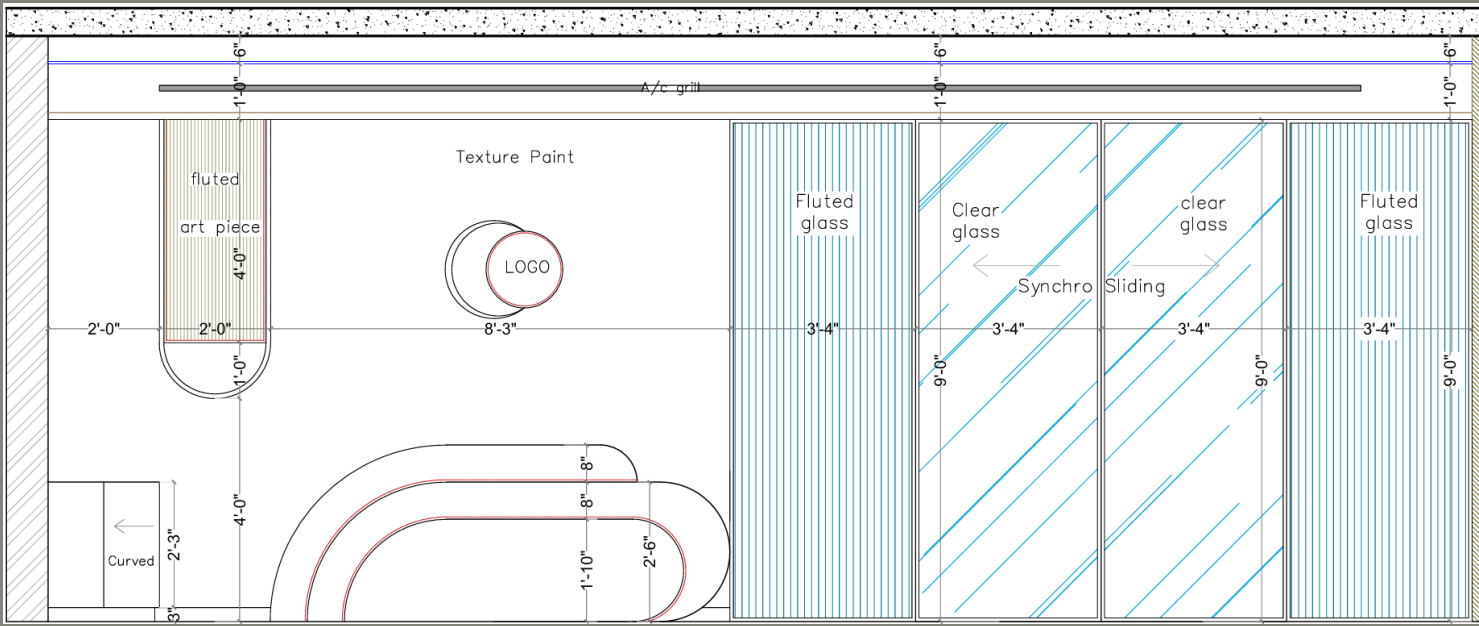

RECEPTION AREA



RECEPTION AREA



RECEPTION AREA

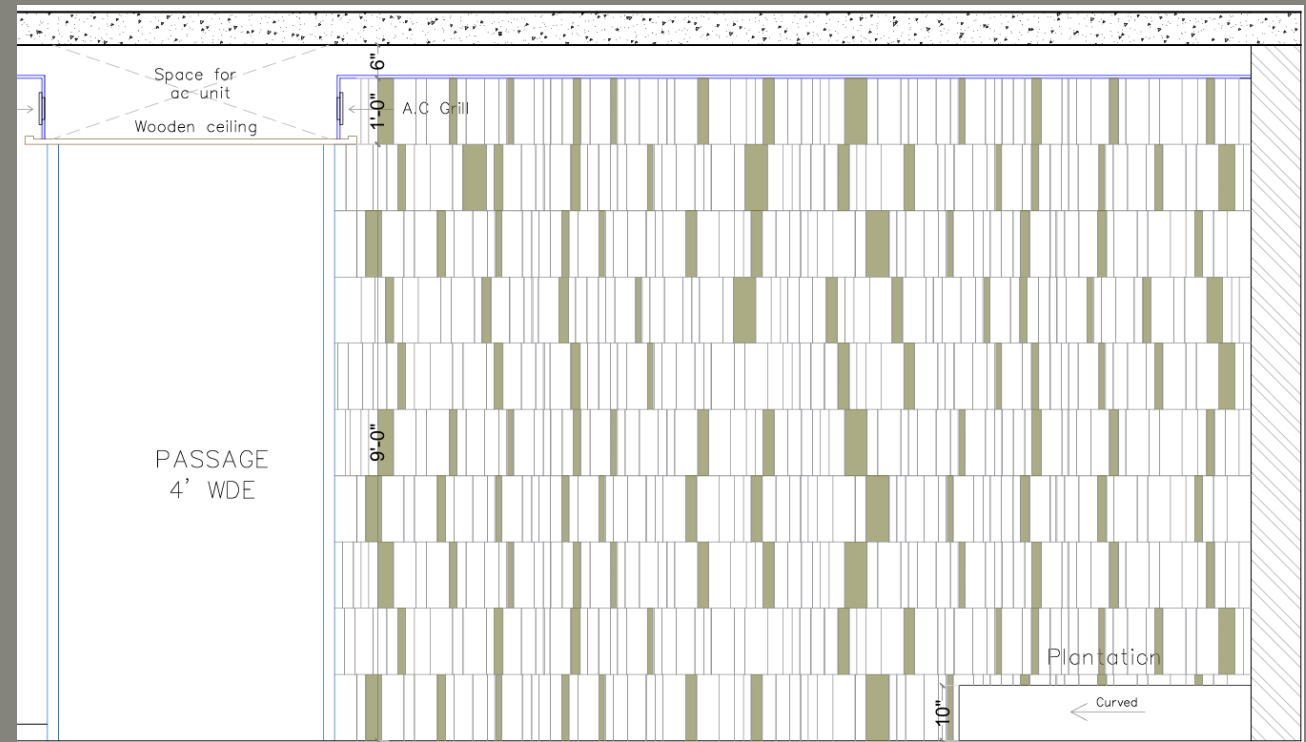
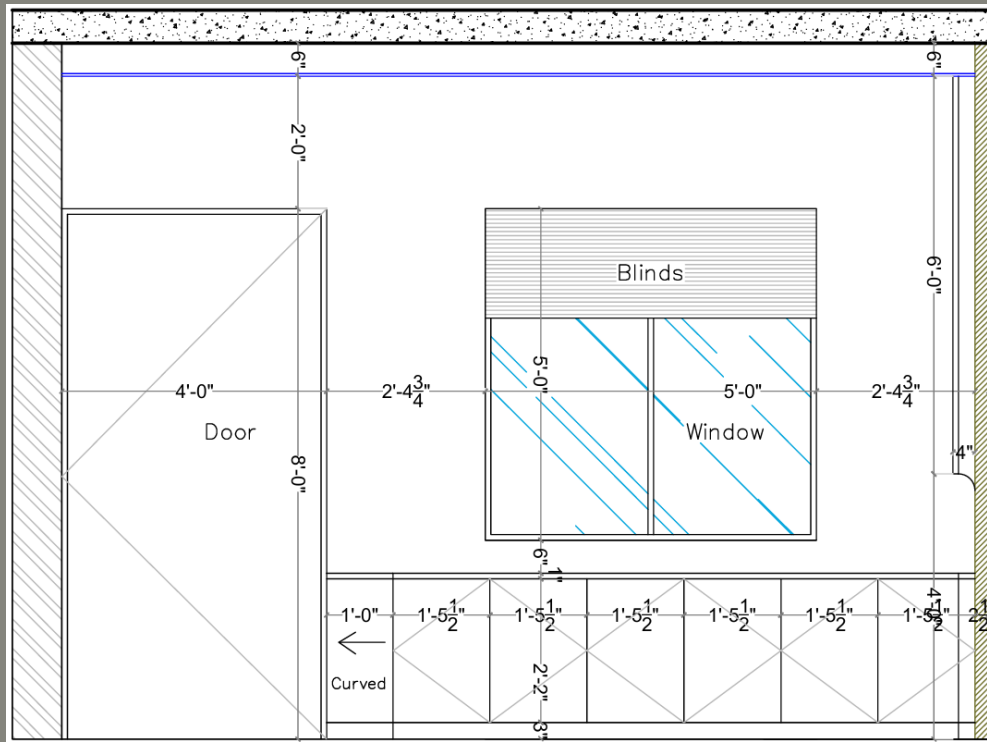

PASSAGE
4' WDE

Plantation

RECEPTION AREA



RECEPTION AREA



PASSAGE AREA

PASSAGE AREA

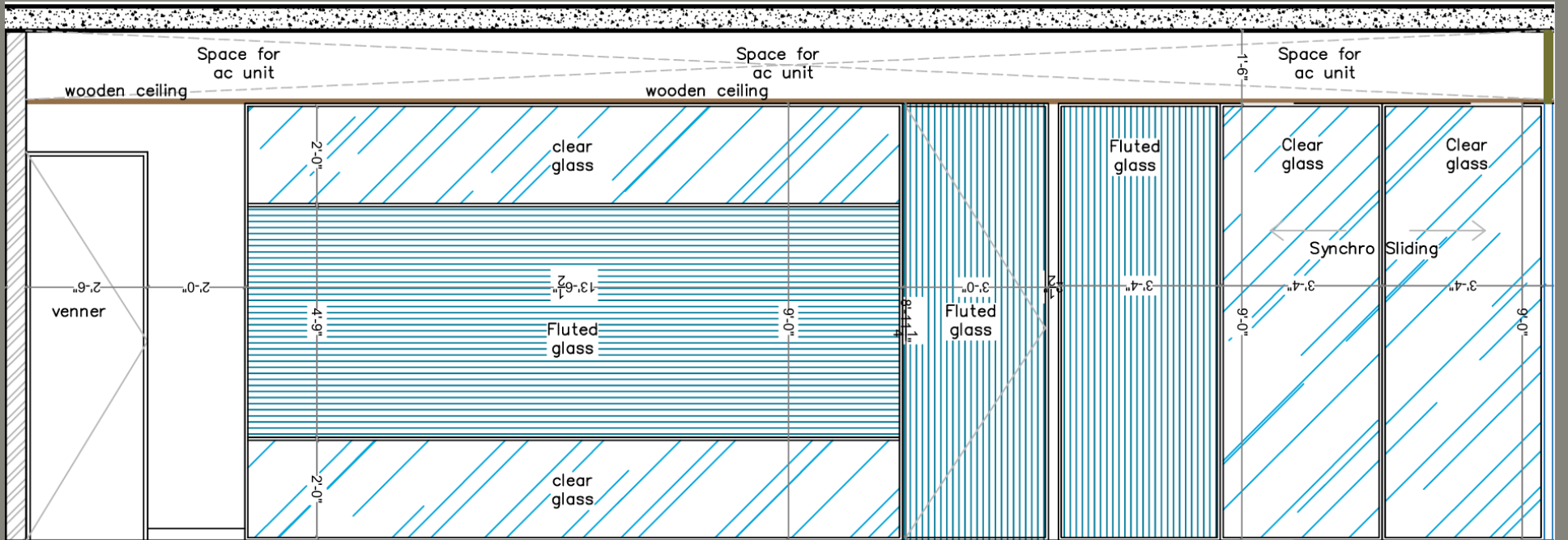
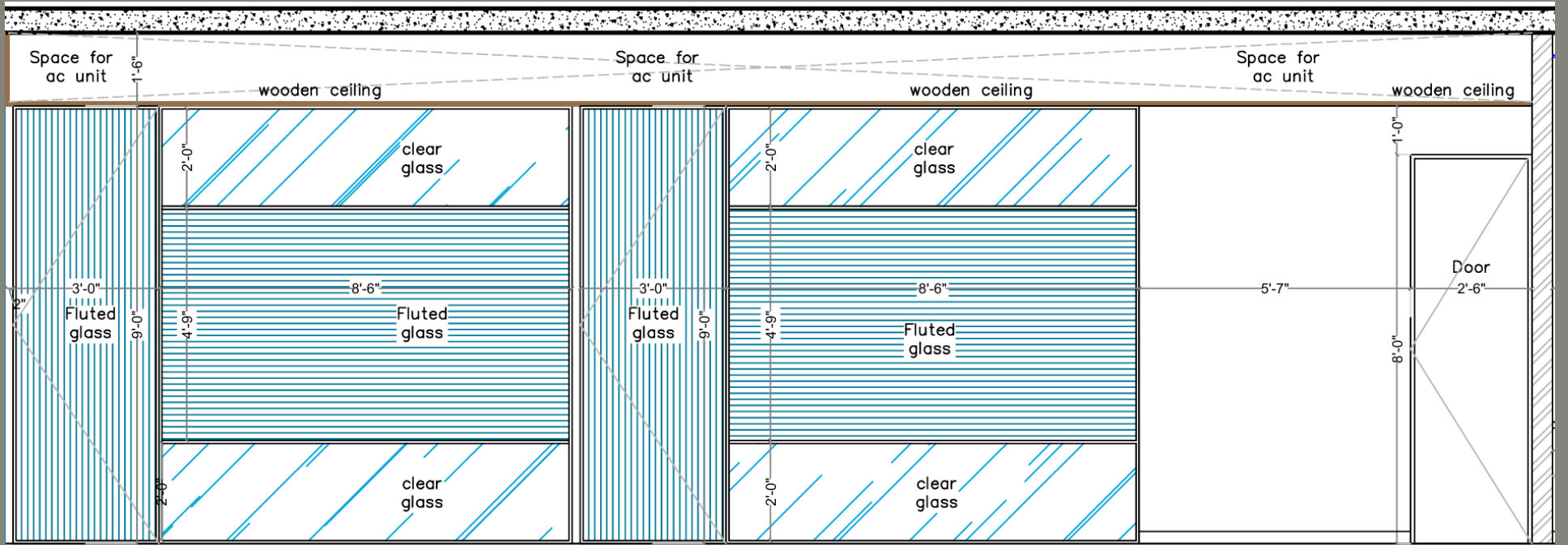

PASSAGE AREA



CONFERENCE ROOM

CONFERENCE ROOM

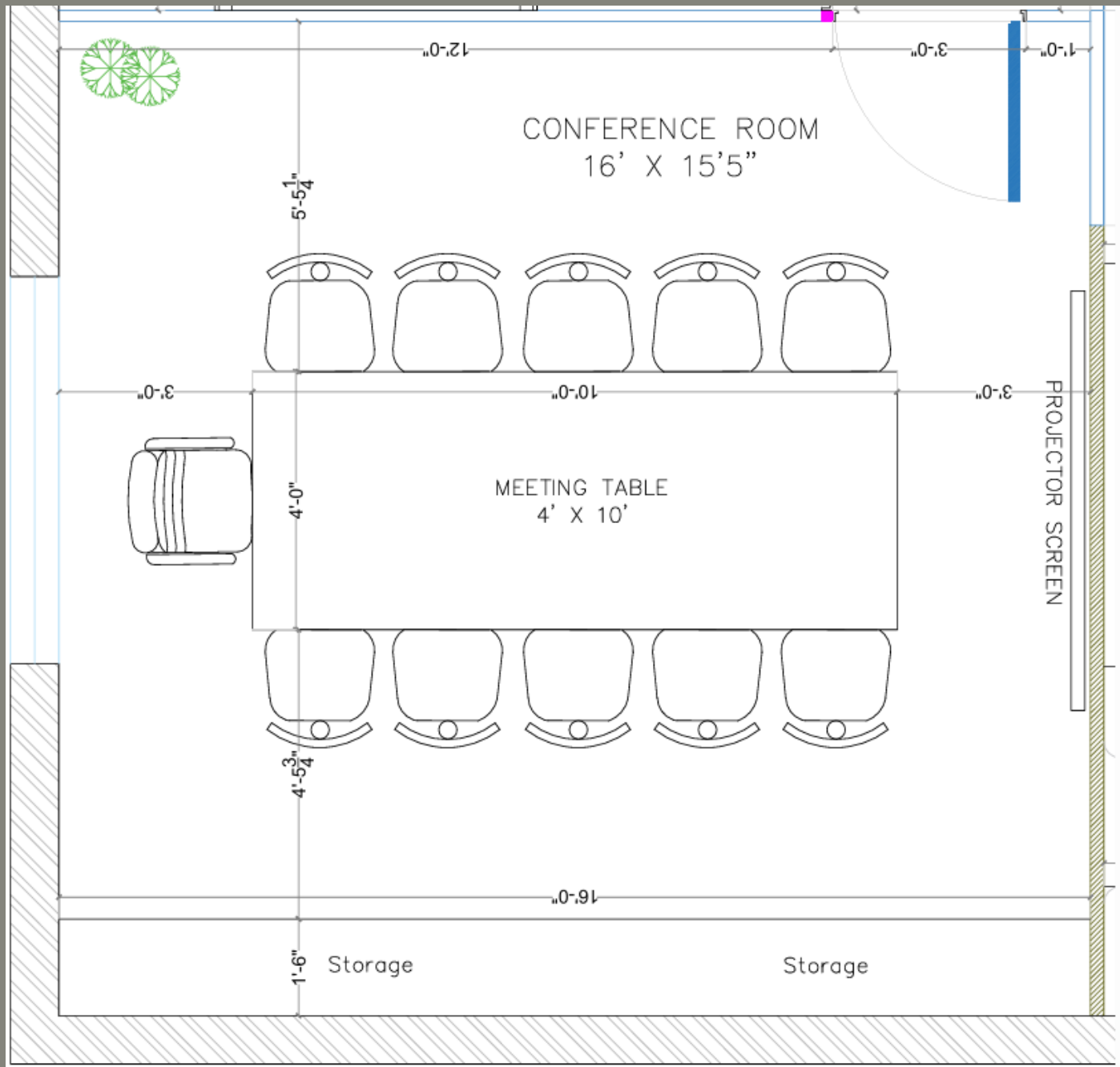

PLAN

CONFERENCE ROOM

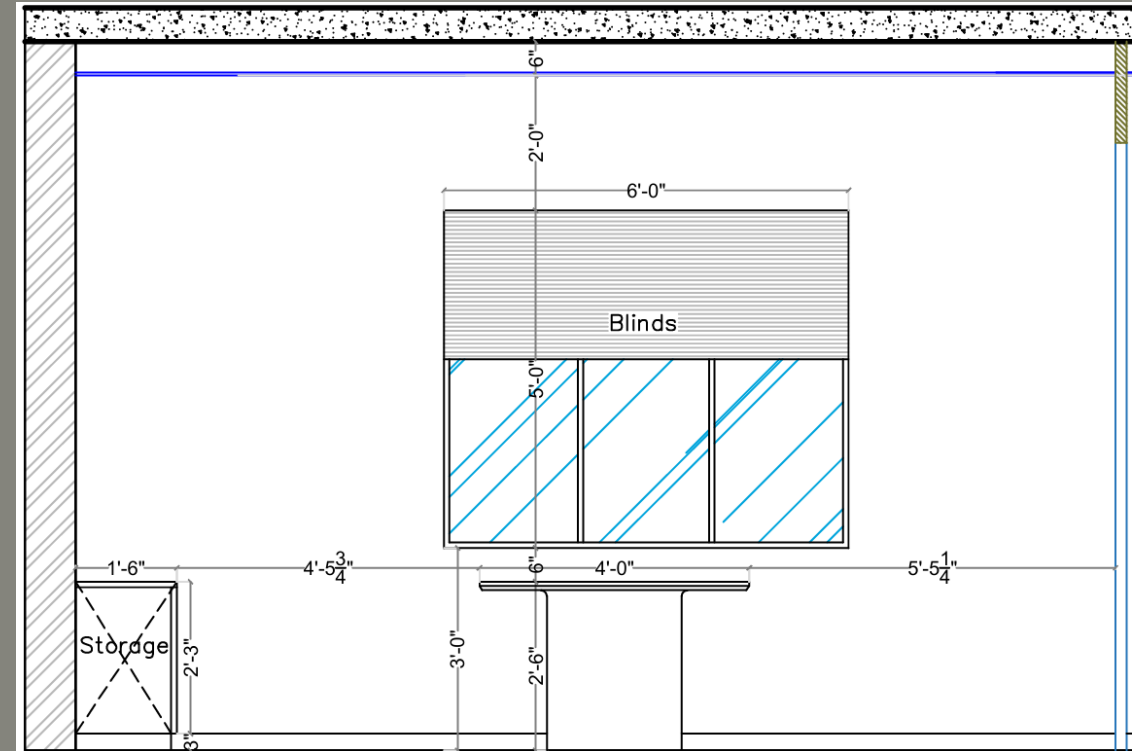
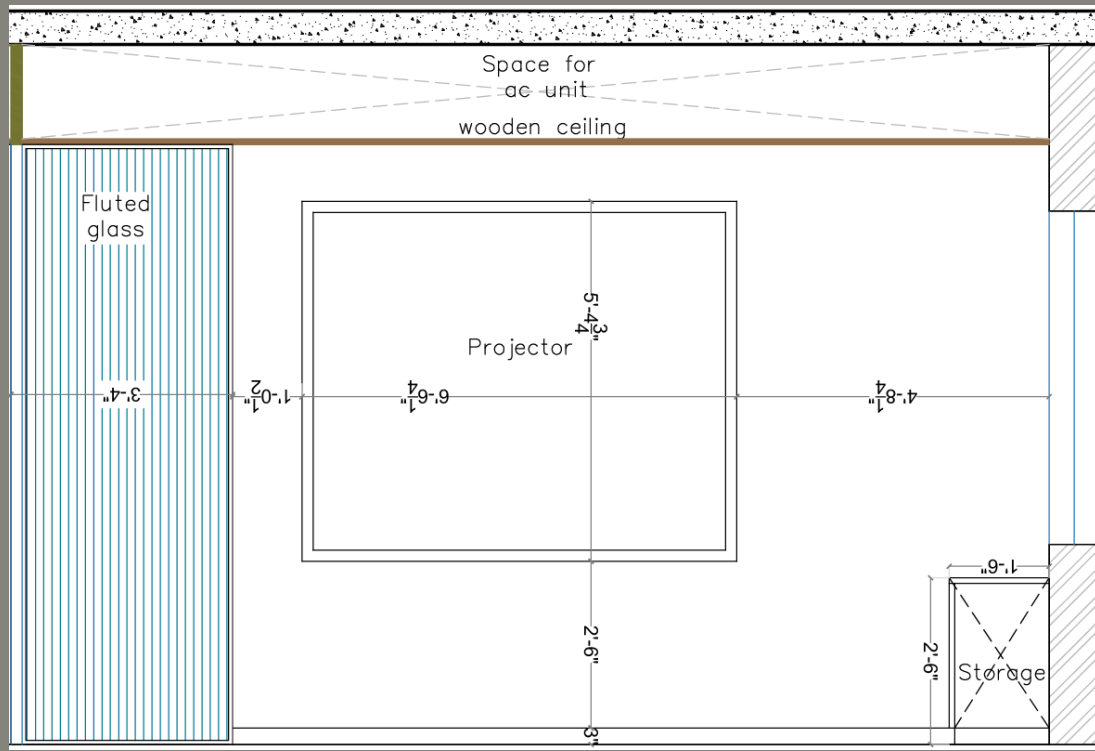

CONFERENCE ROOM



CONFERENCE ROOM

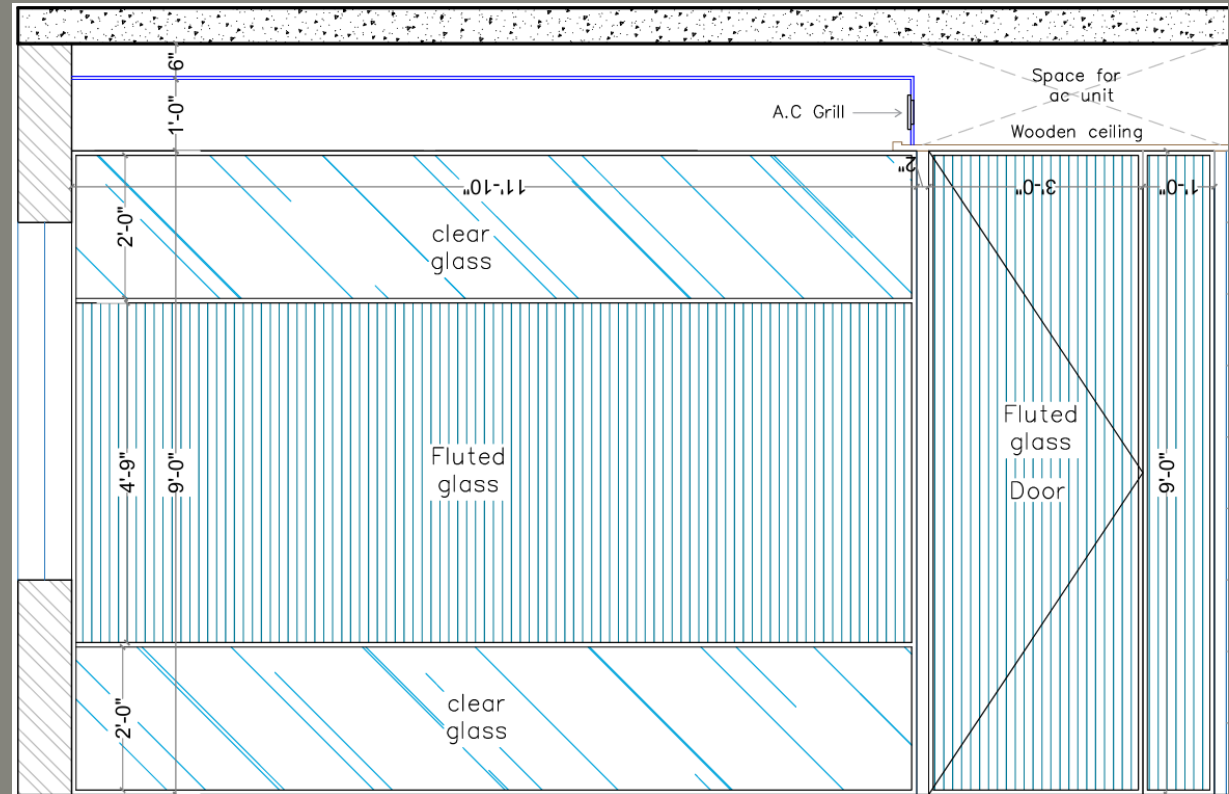
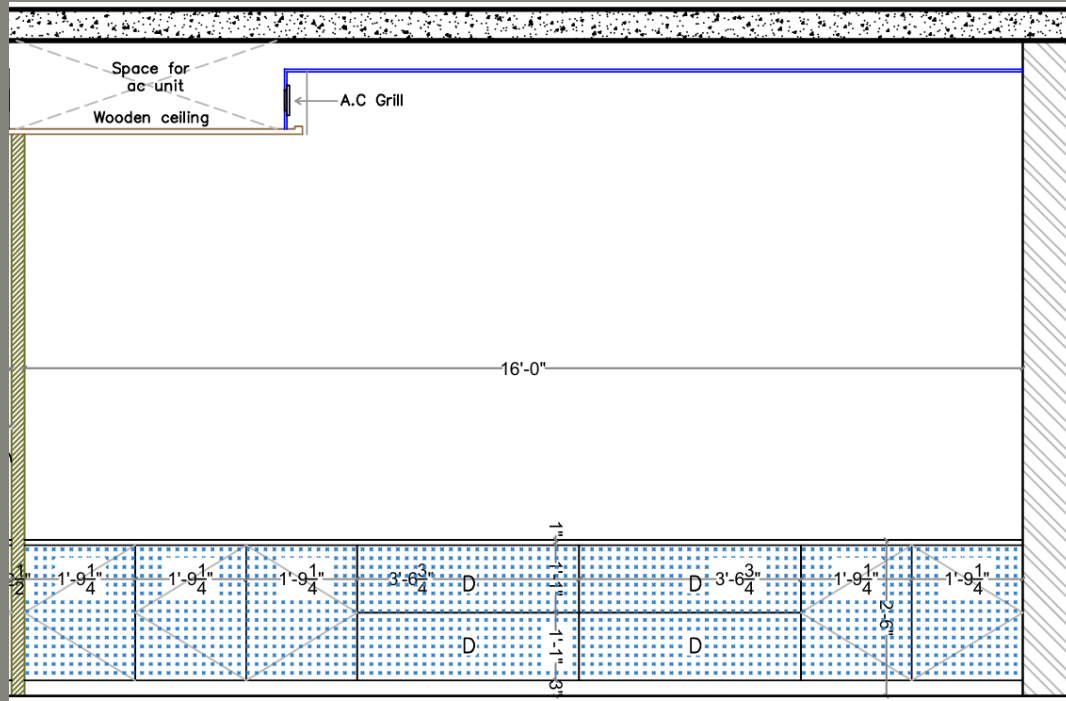

CONFERENCE ROOM



CONFERENCE ROOM



M.D CABIN – 1

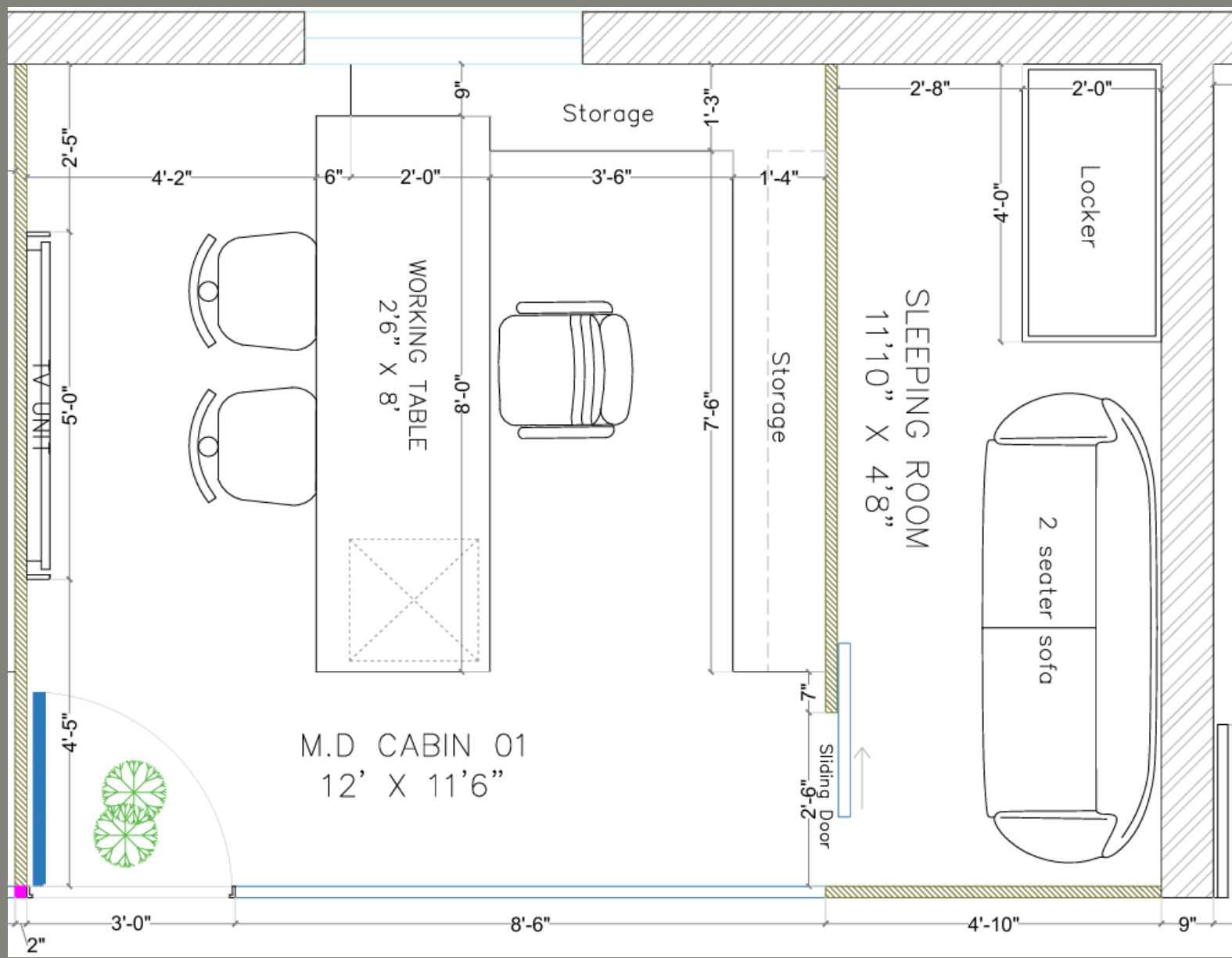

PLAN

M.D CABIN -01

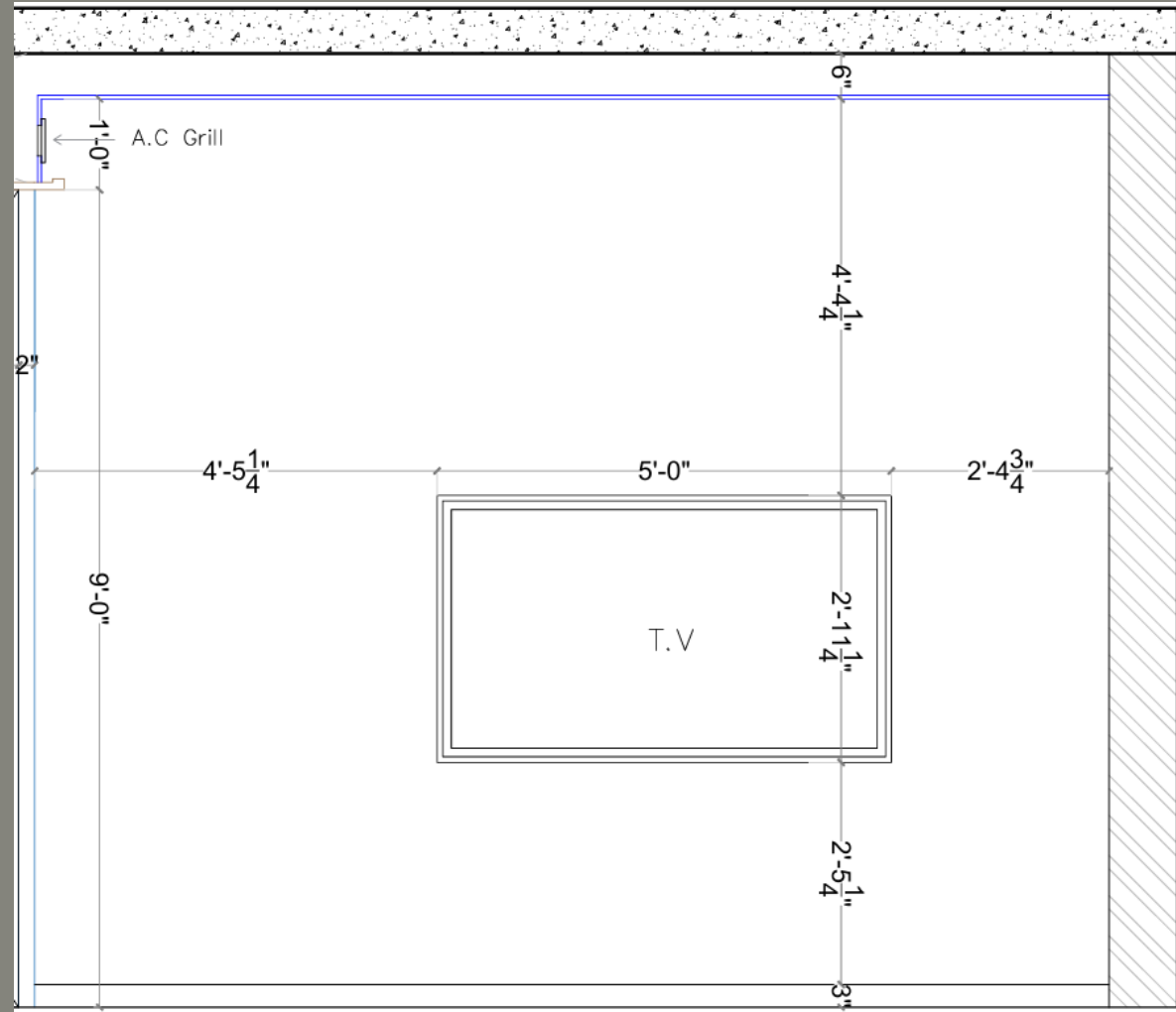
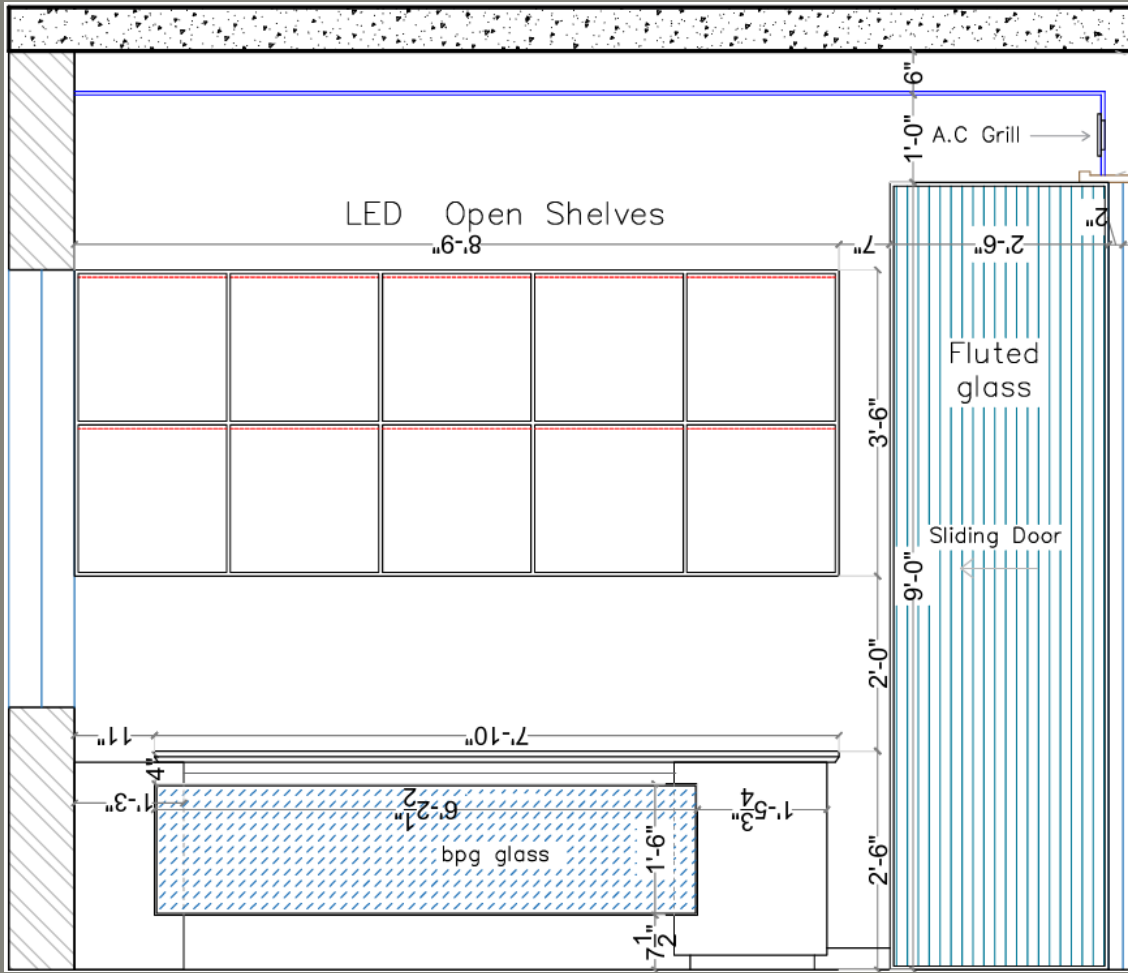



M.D CABIN -01

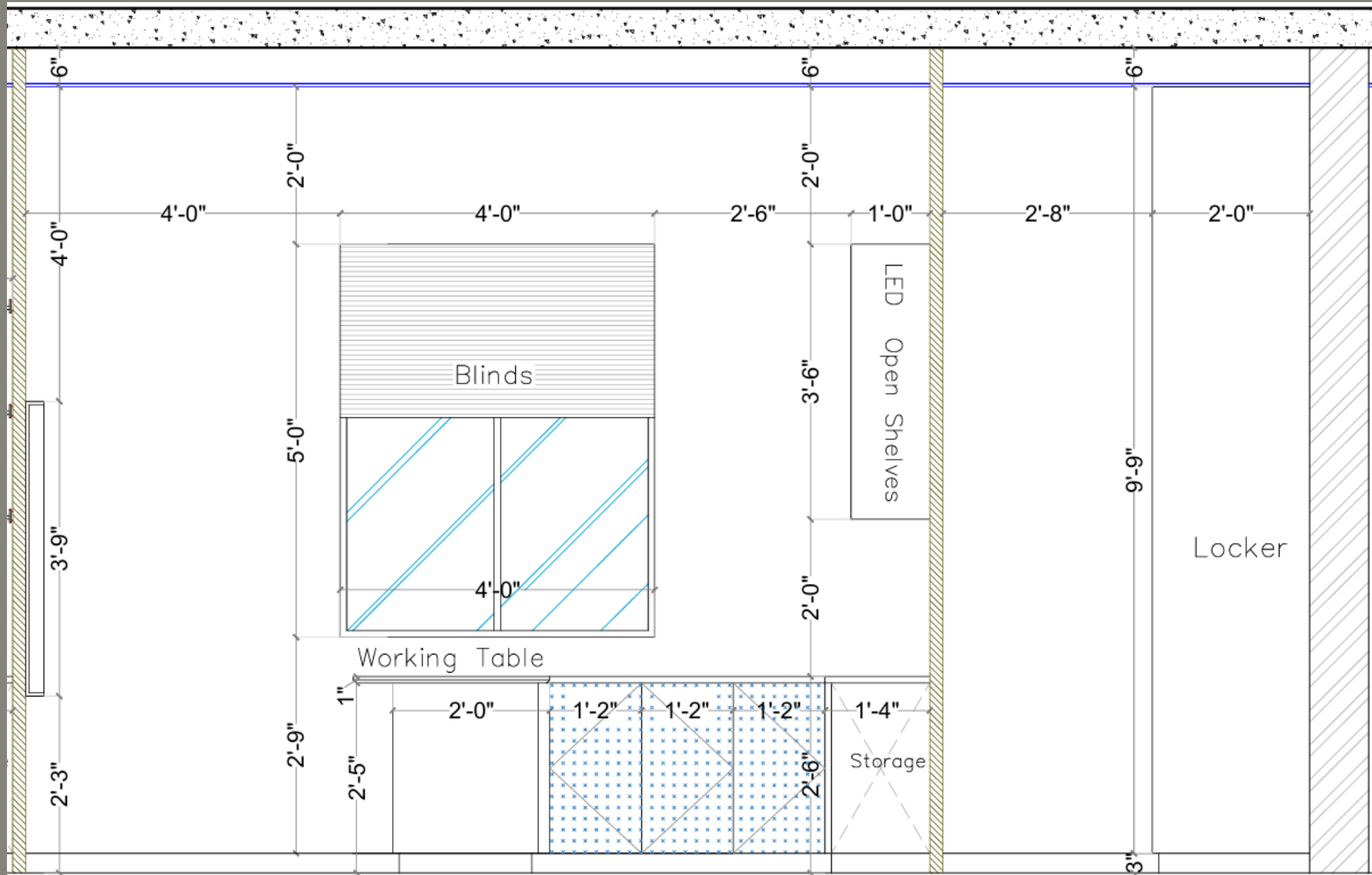



M.D CABIN -2

PLAN

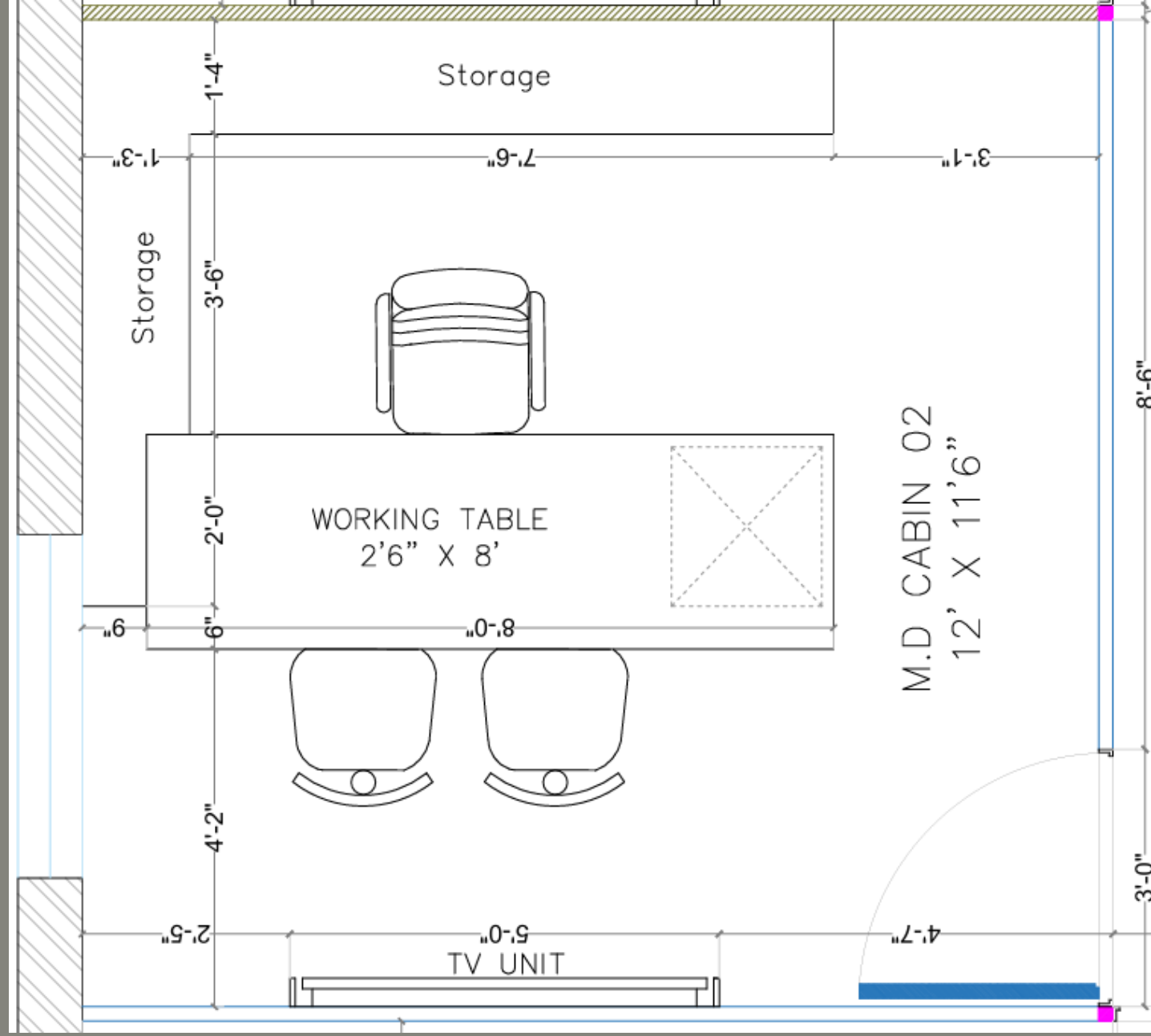

M.D CABIN -02

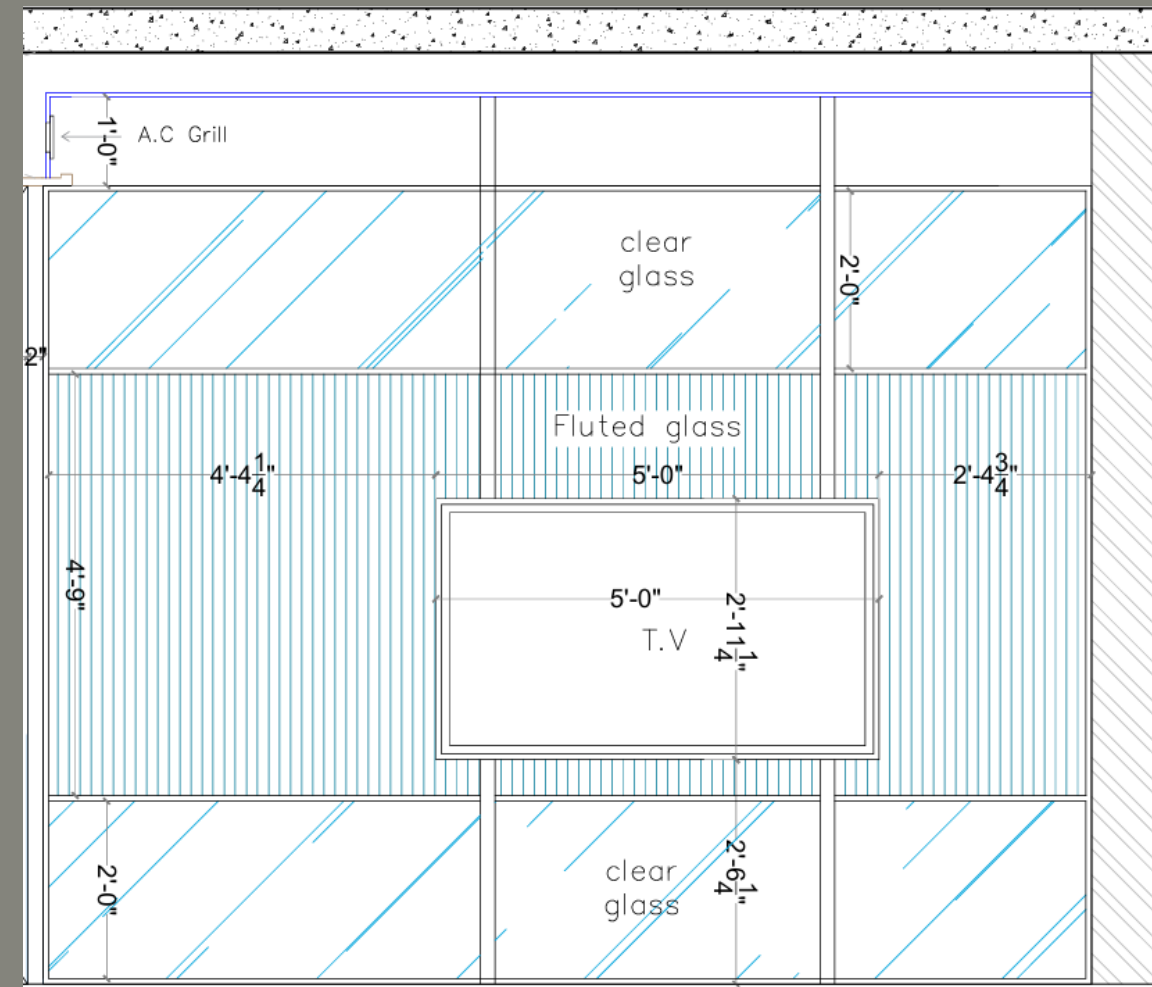
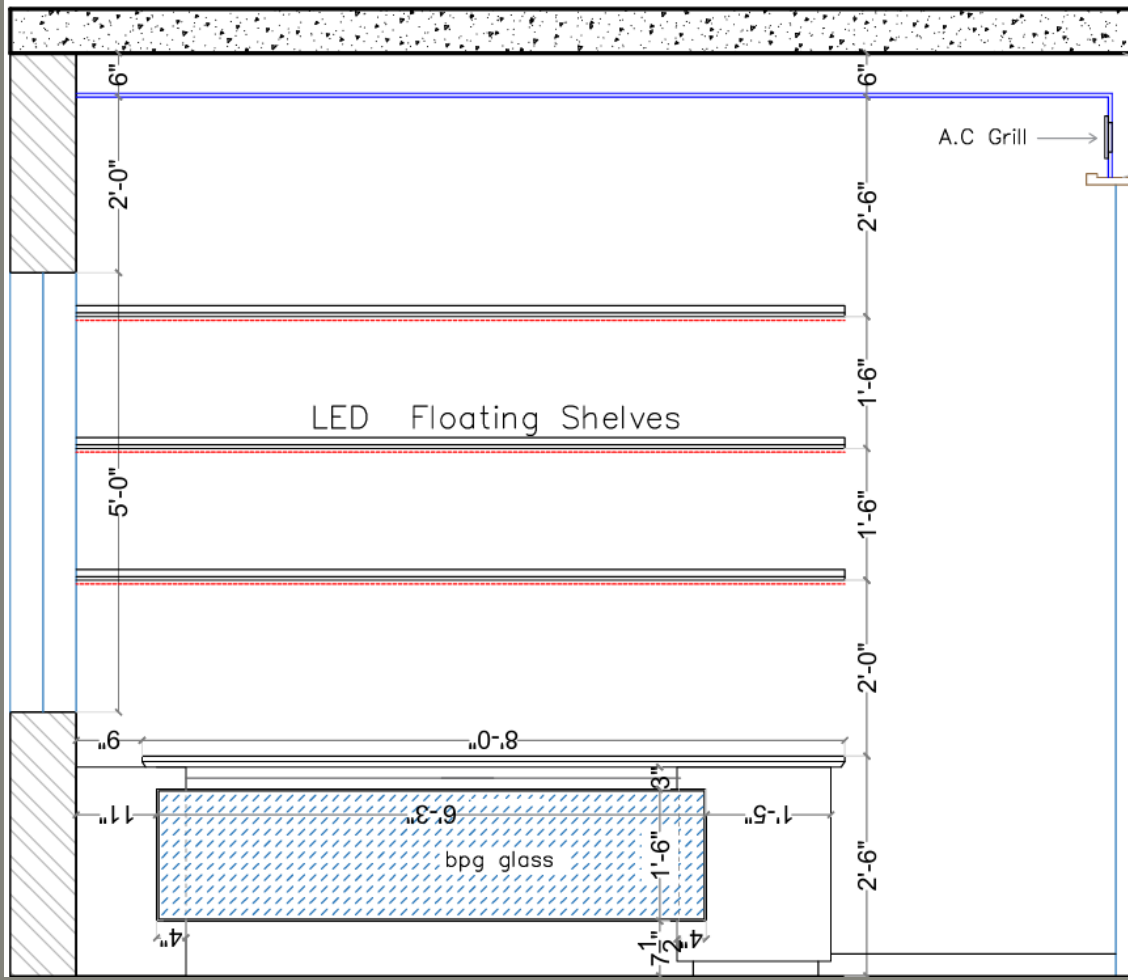



M.D CABIN -02

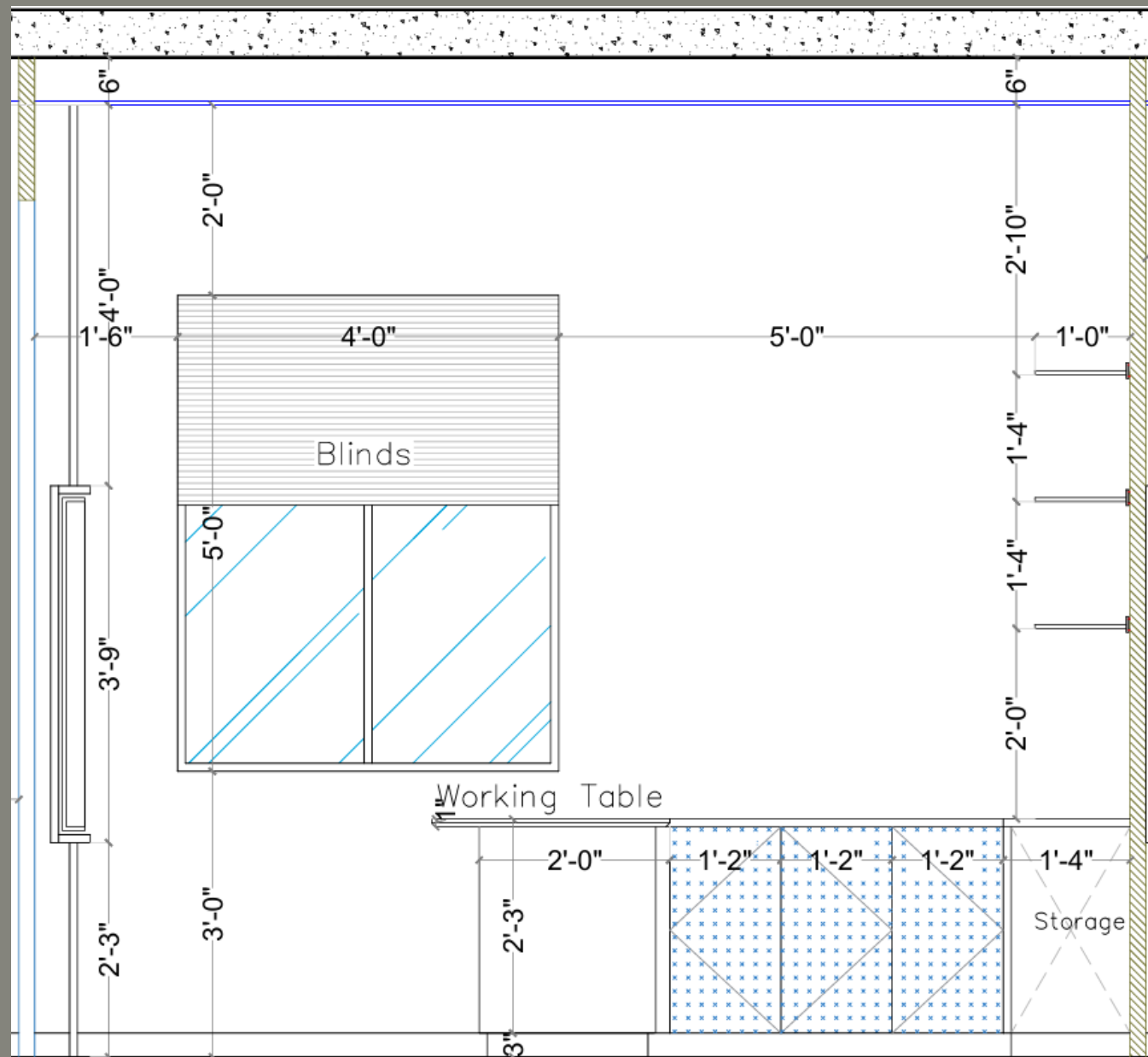



OFFICE

OFFICE

PLAN

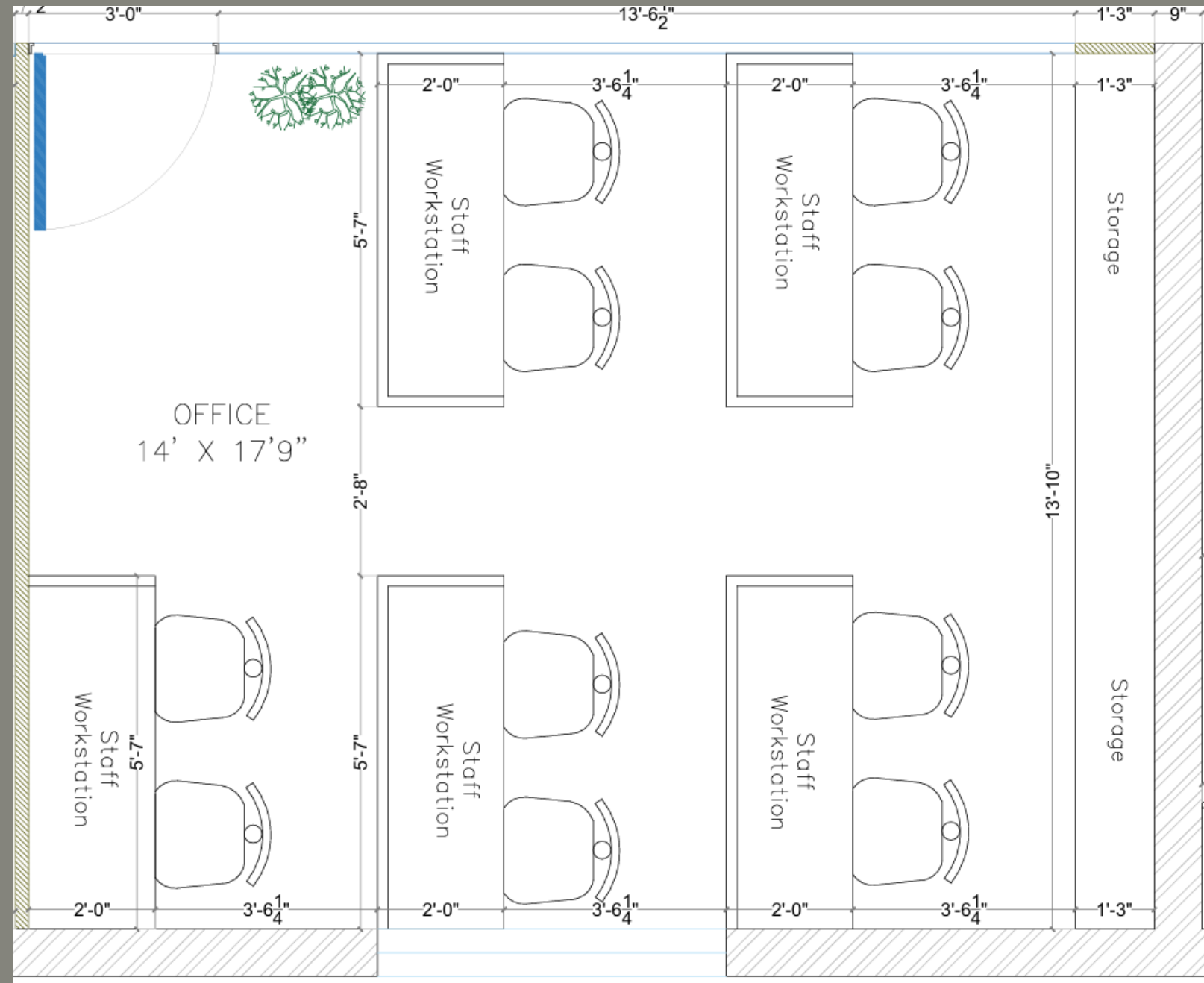

OFFICE

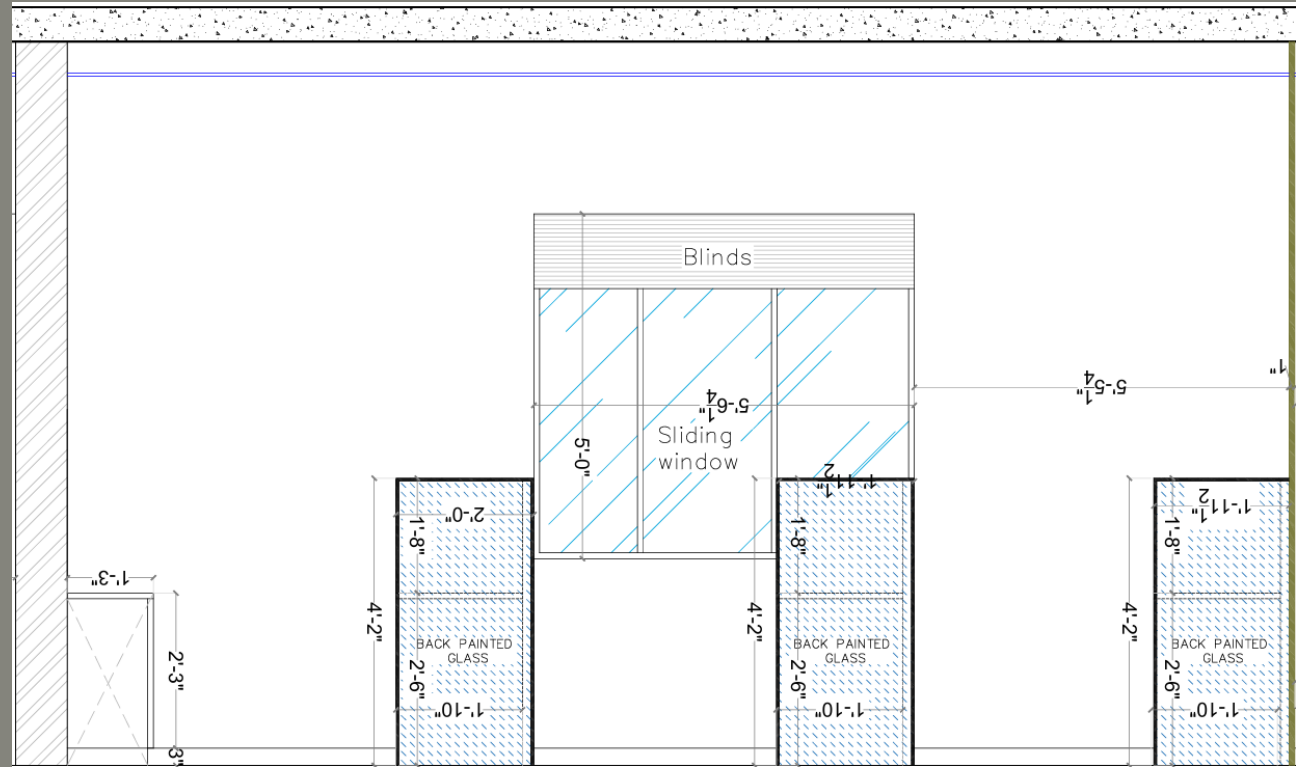
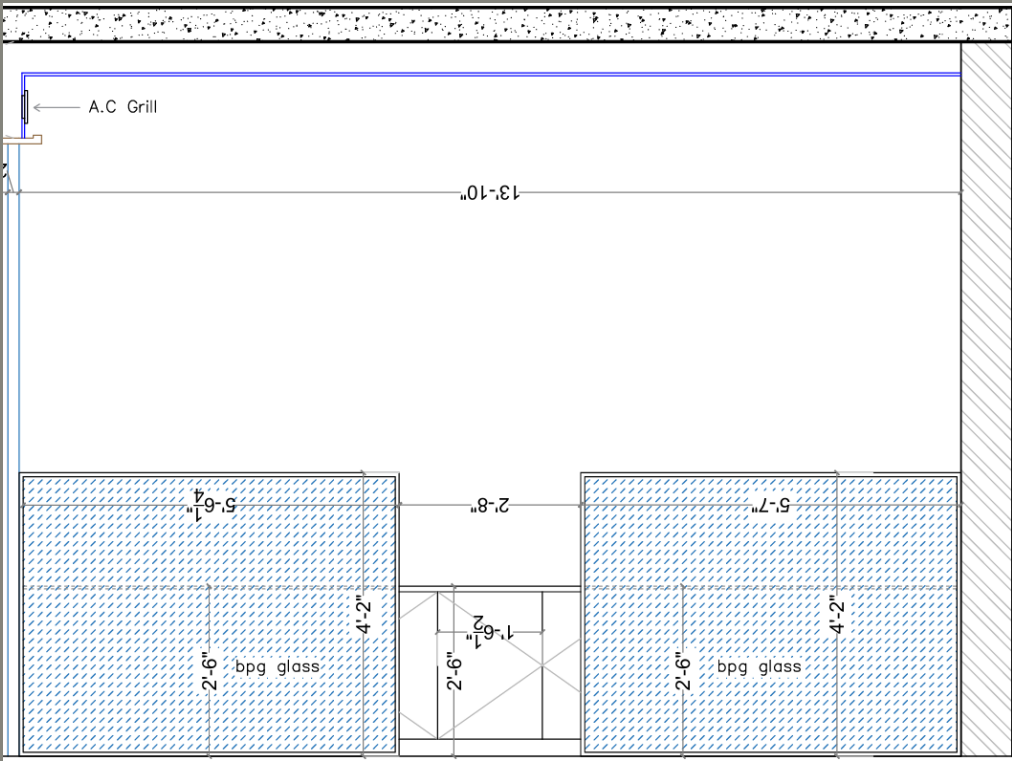



OFFICE



THANK YOU