

GROOVE  
DESIGNS

# INTERIOR PRESENTATION

YOGESH JAIN,  
VIJAYAWADA

# FLOOR PLAN

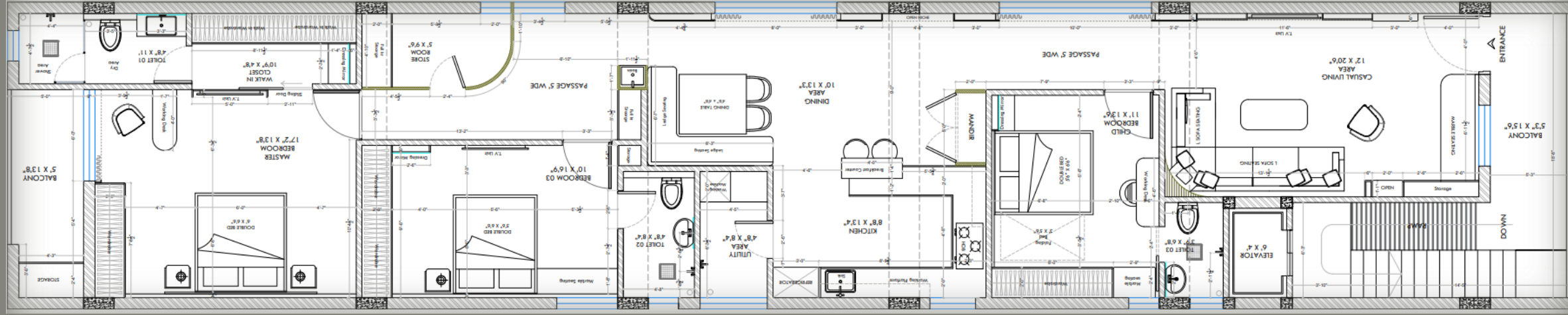

CASUAL LIVING AREA

# CASUAL LIVING AREA

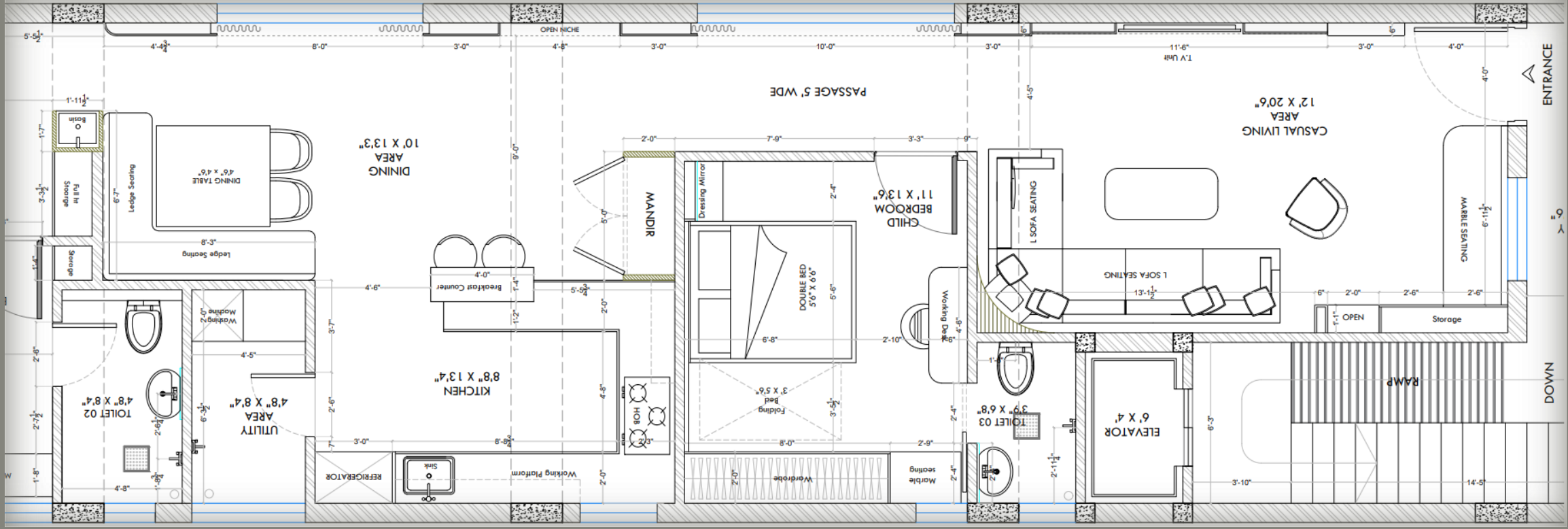

# CASUAL LIVING AREA

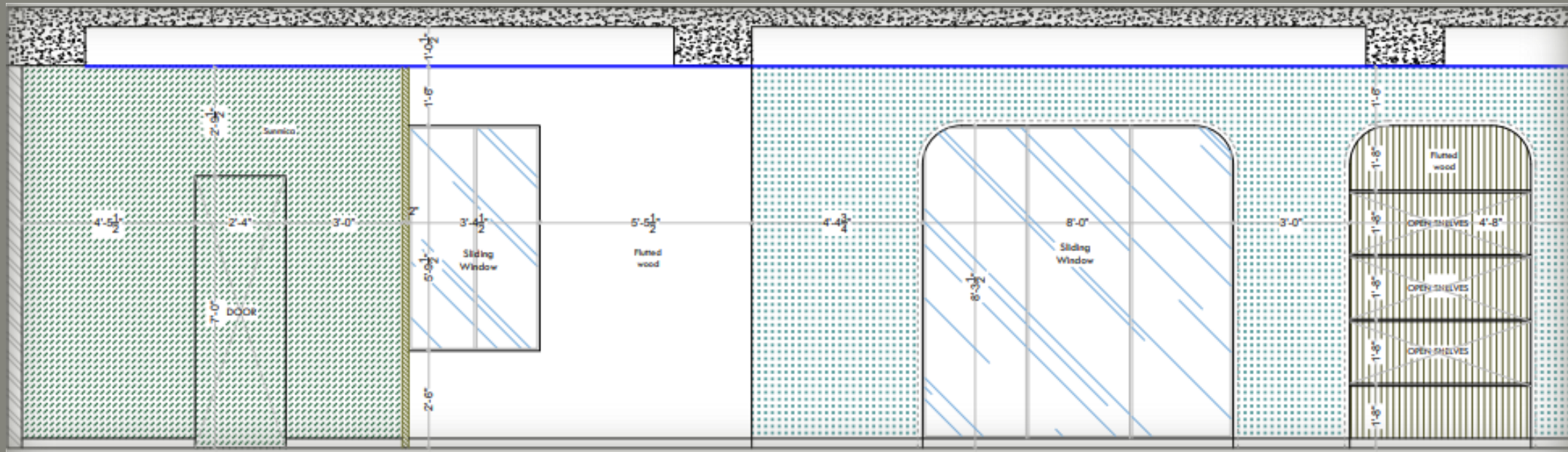
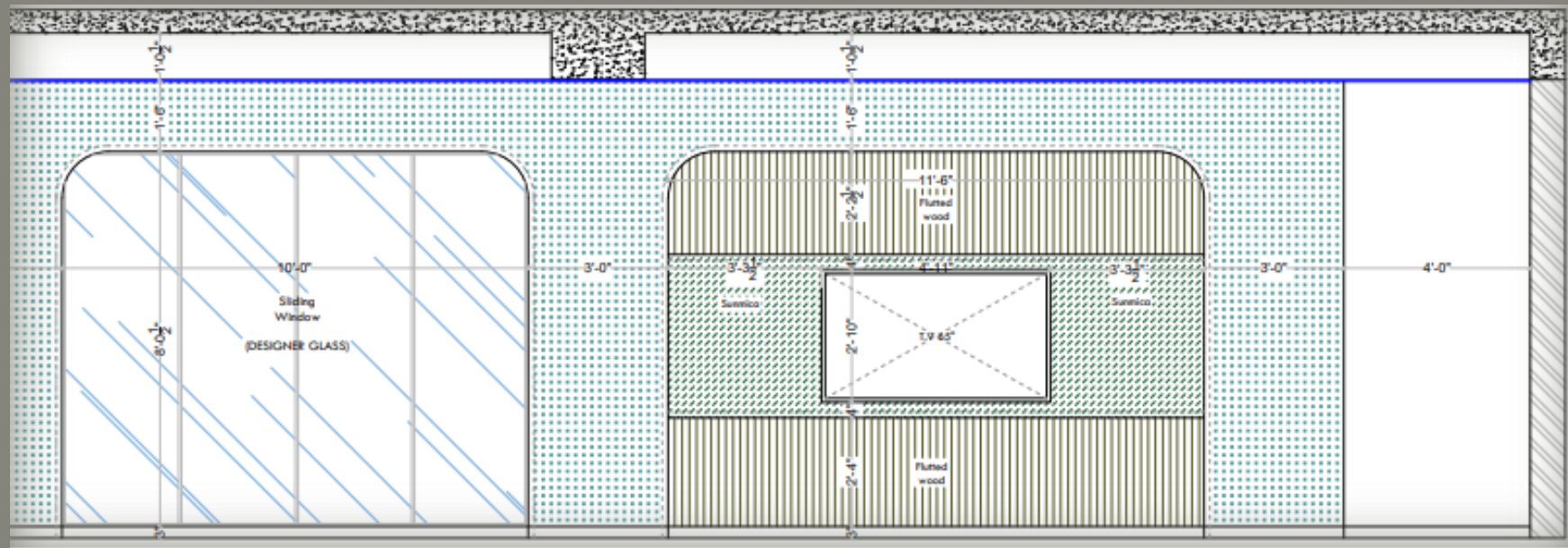

CASUAL LIVING AREA



CASUAL LIVING AREA



CASUAL LIVING AREA



CASUAL LIVING AREA



CASUAL LIVING AREA



# KITCHEN & DINING AREA

# CASUAL LIVING AREA

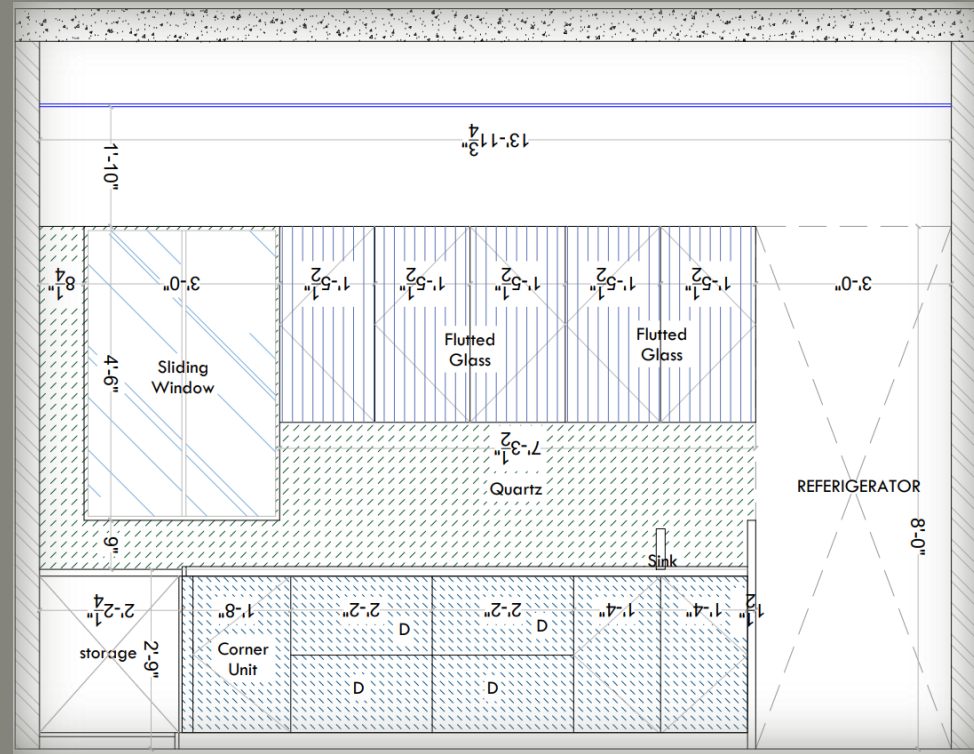
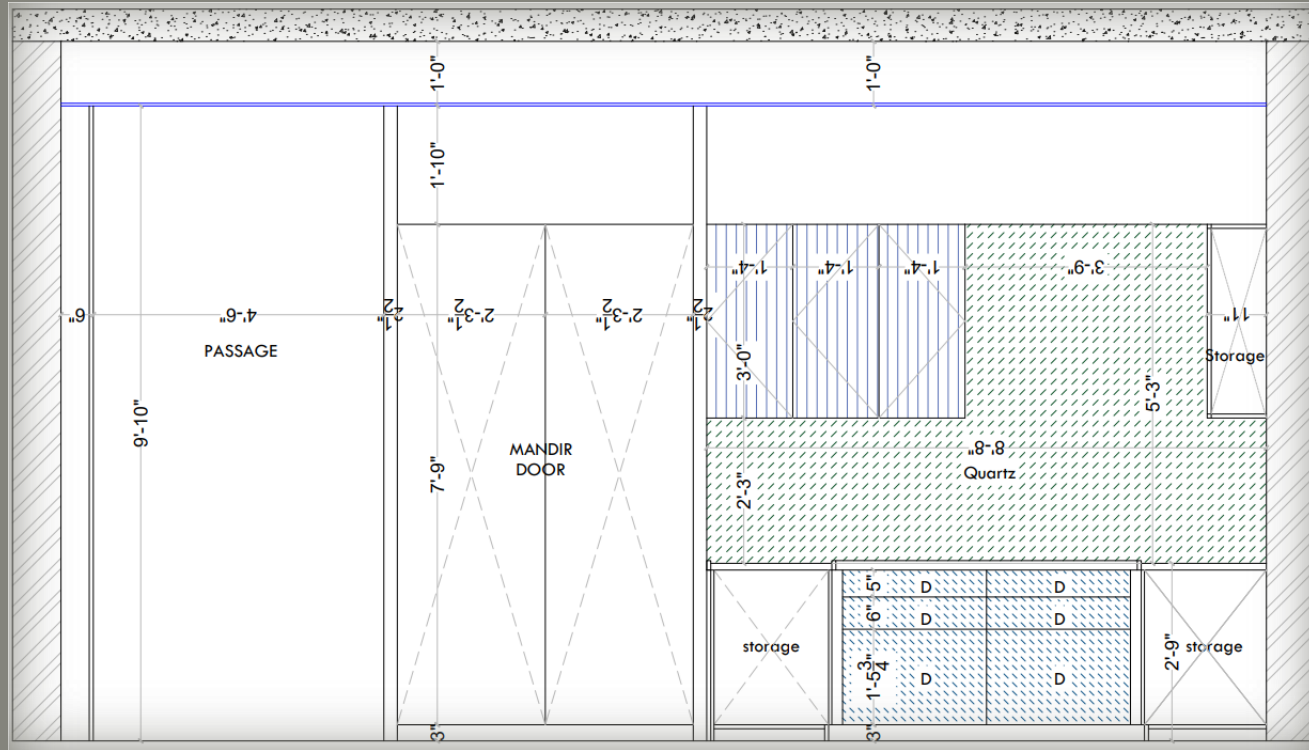

CASUAL LIVING AREA



CASUAL LIVING AREA



# CASUAL LIVING AREA

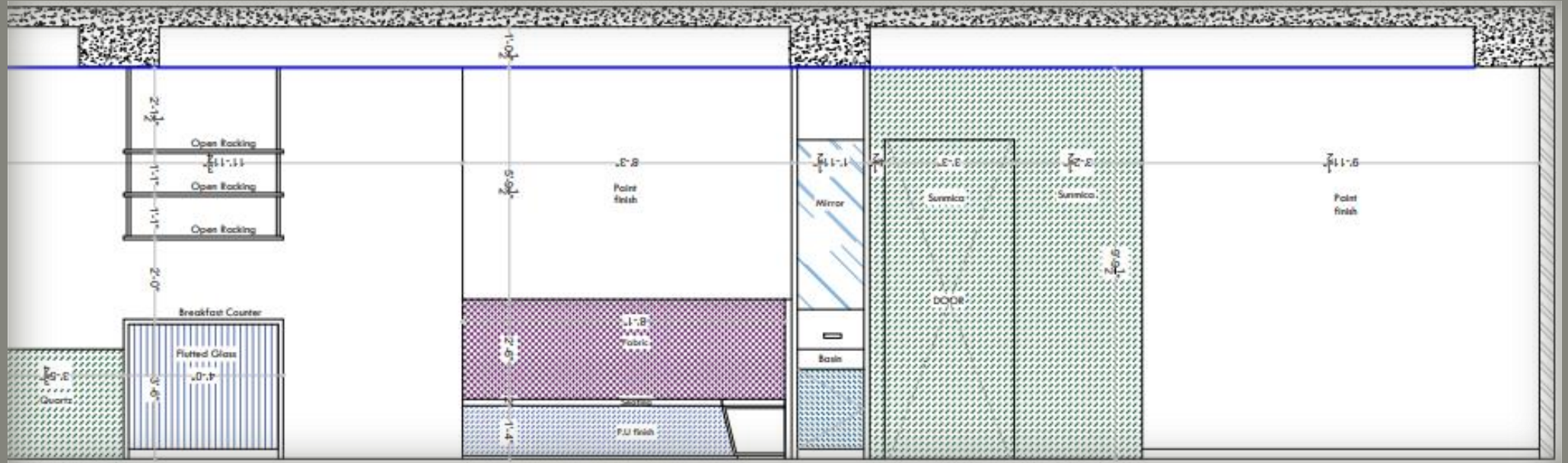
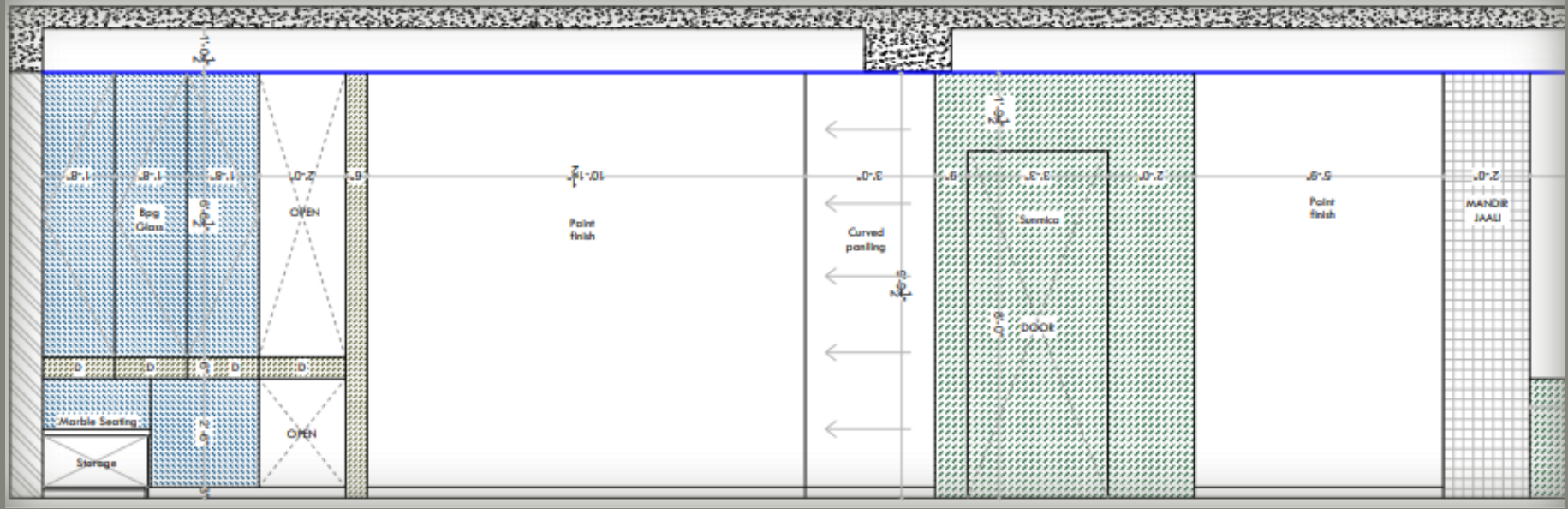

CASUAL LIVING AREA



CASUAL LIVING AREA



CASUAL LIVING AREA



PASSAGE

CASUAL LIVING AREA



CASUAL LIVING AREA



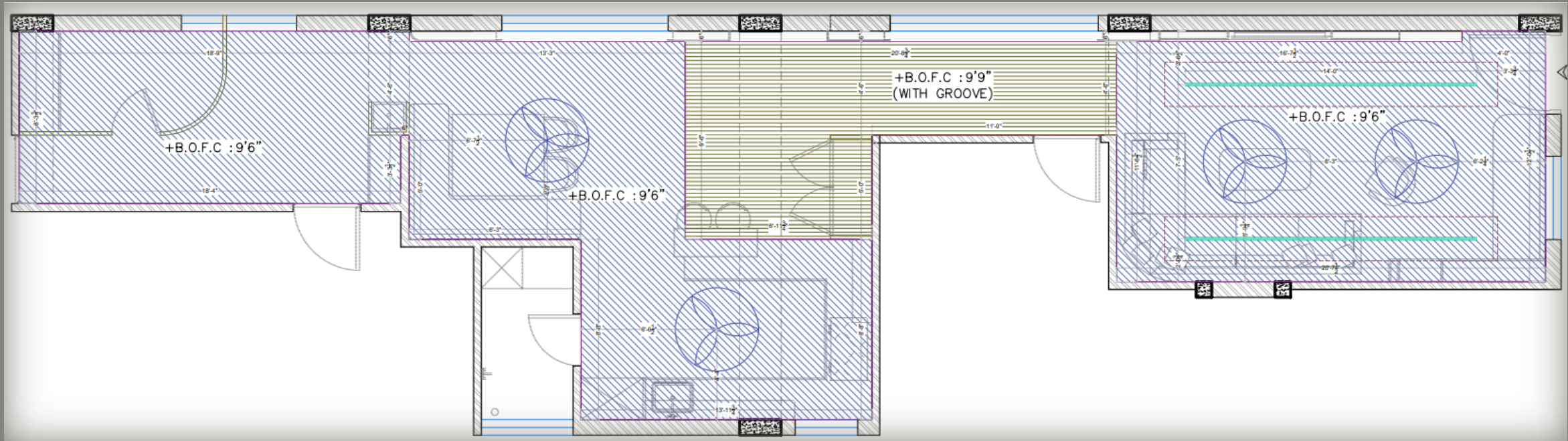

CEILING LAYOUT

# CASUAL LIVING AREA

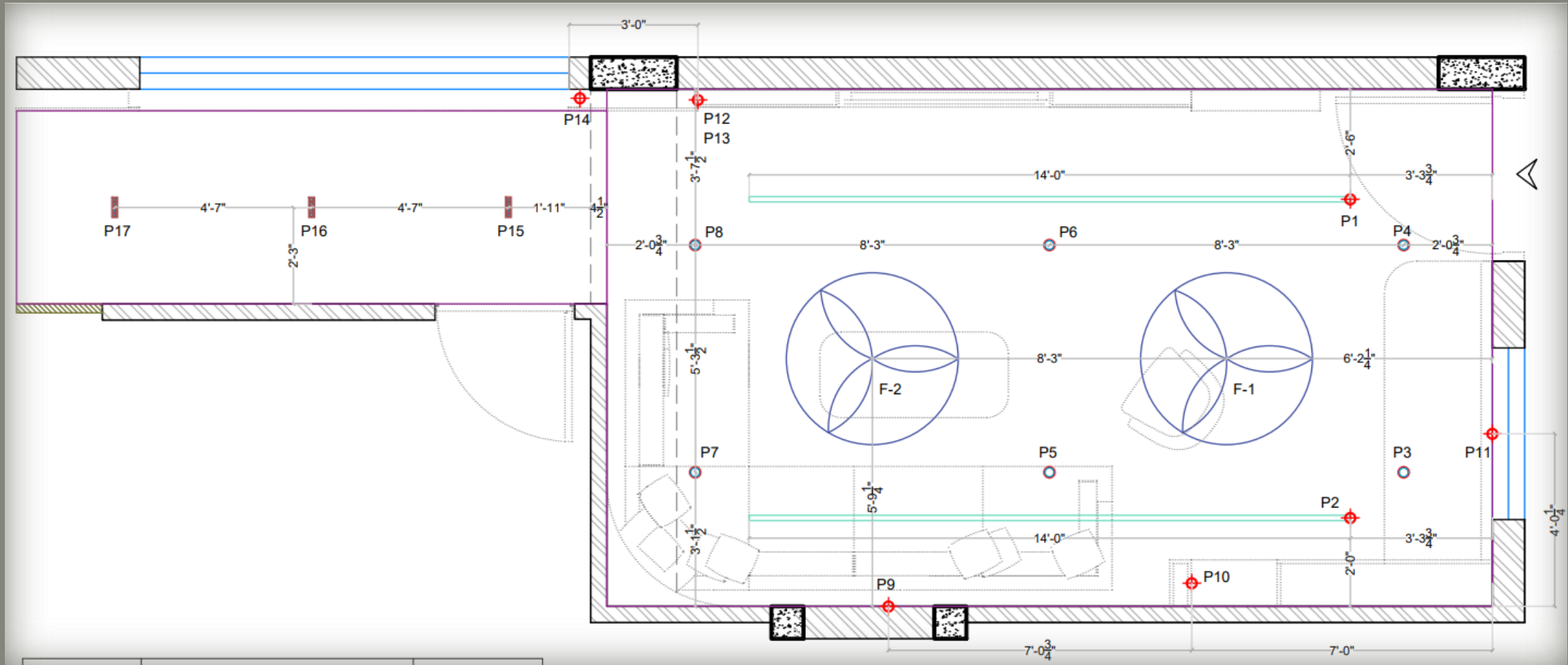

ELECTRICAL LAYOUT

# CASUAL LIVING AREA

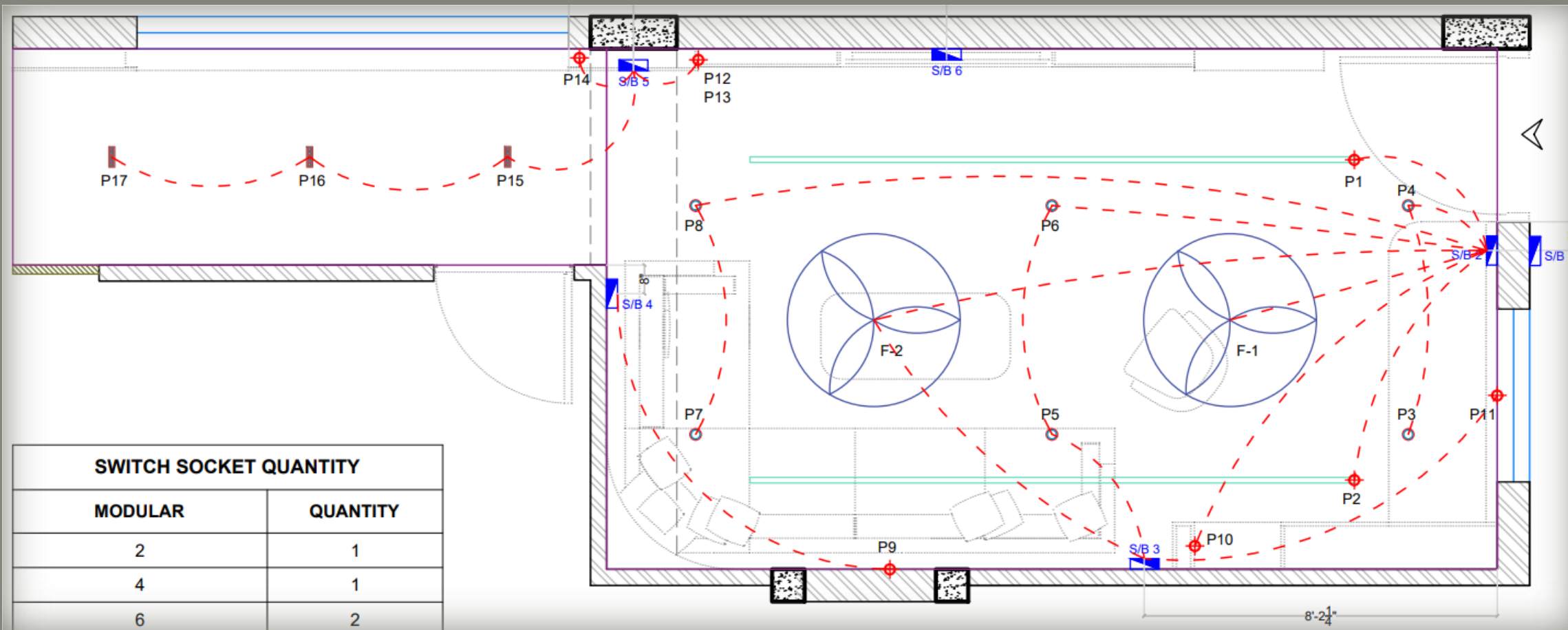

SWITCH SOCKET QUANTITY	
MODULAR	QUANTITY
2	1
4	1
6	2

ELECTRICAL LOOPING LAYOUT

# KITCHEN & PASSAGE AREA

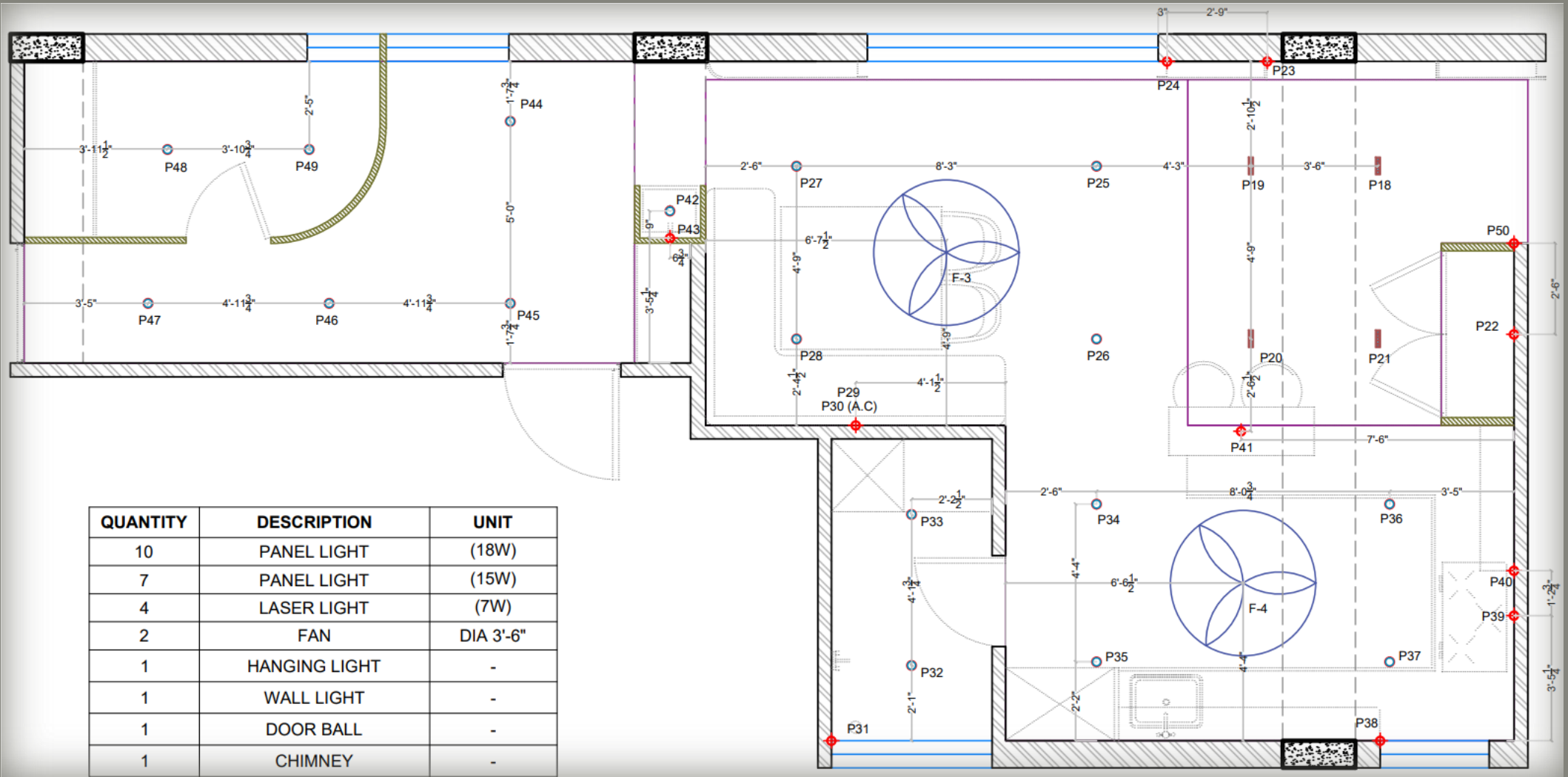

ELECTRICAL LAYOUT

# KITCHEN & PASSAGE AREA

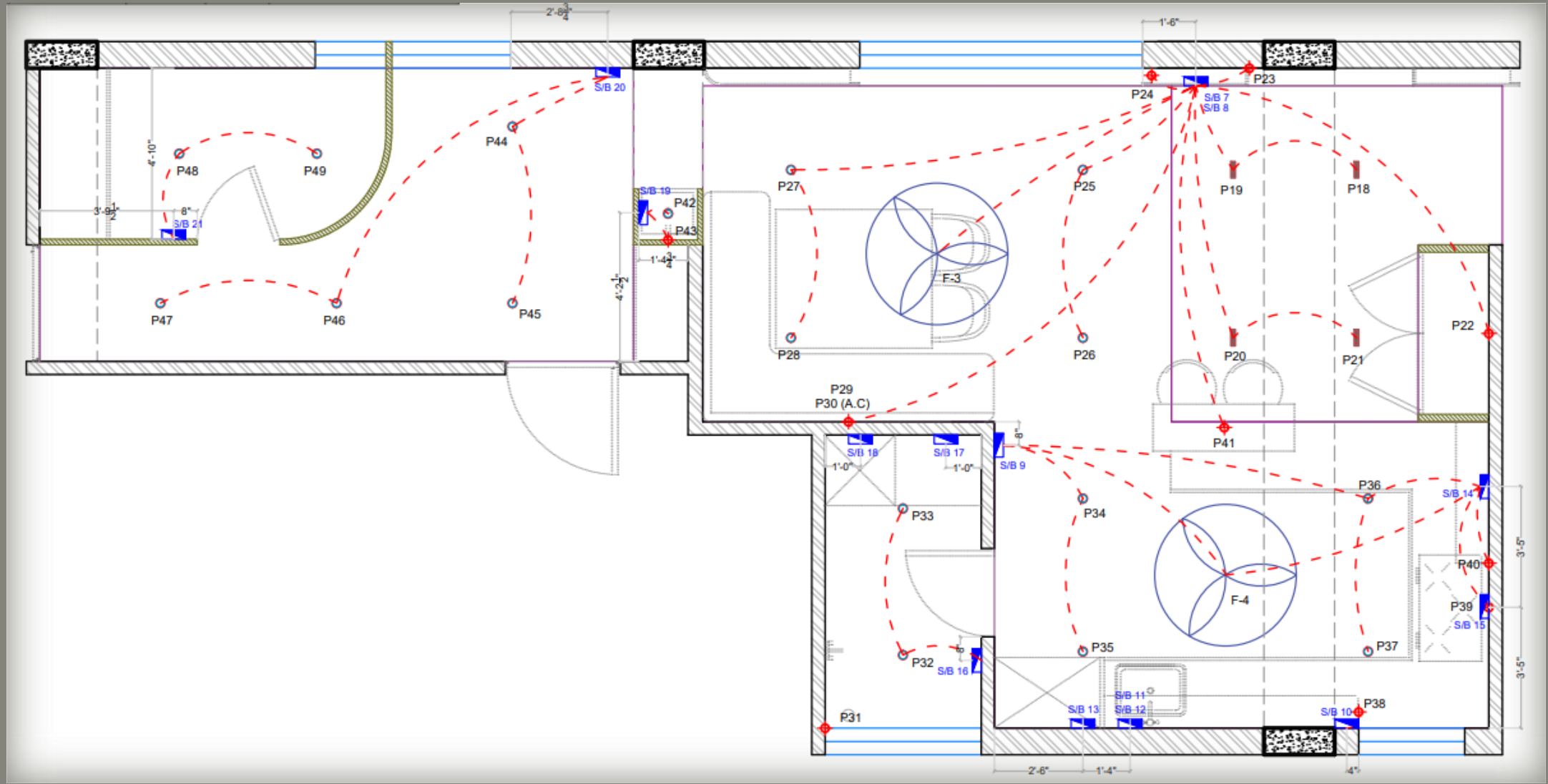

ELECTRICAL LOOPING LAYOUT

**MASTER BEDROOM  
OPTION-01**

# MASTER BEDROOM

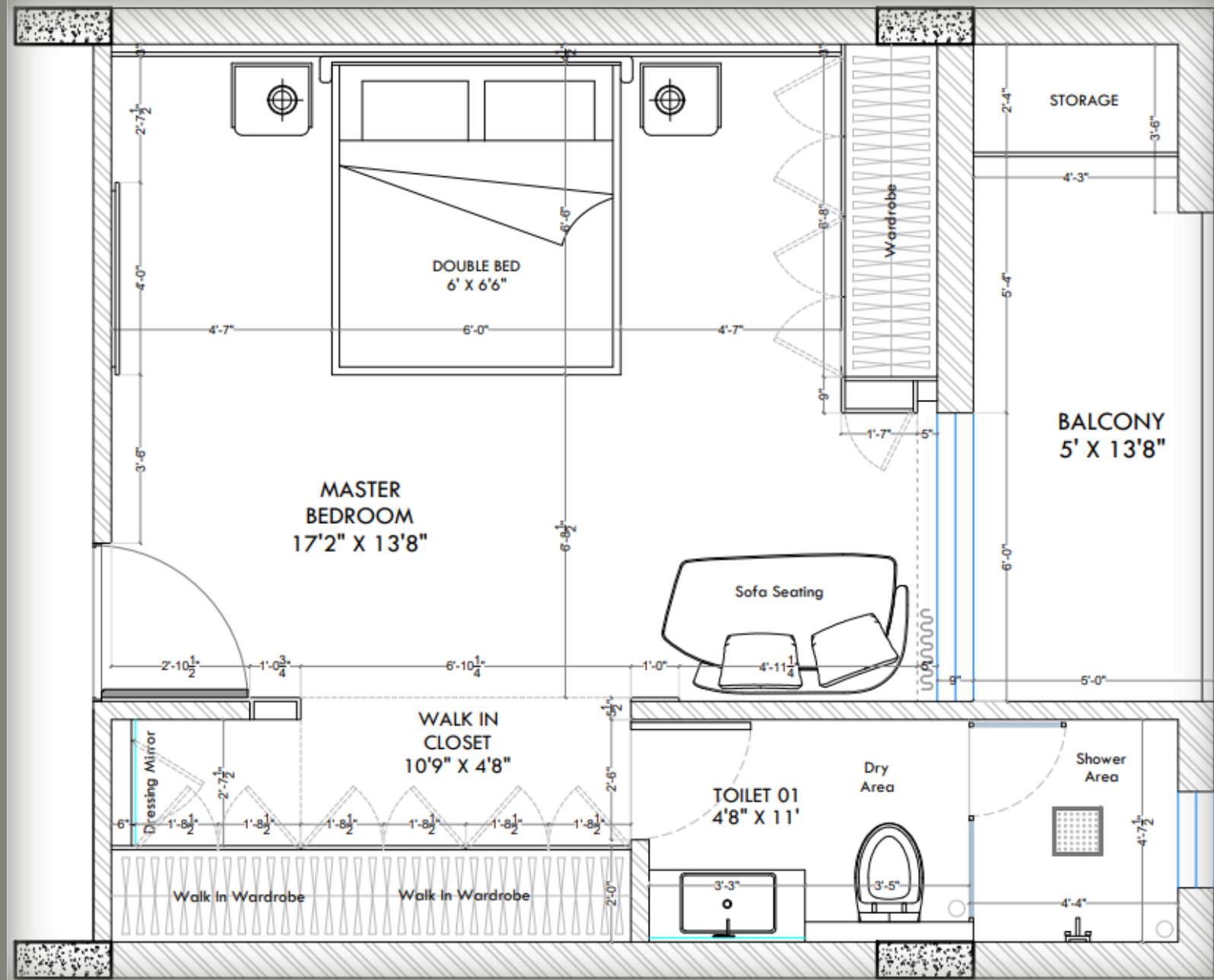

# MASTER BEDROOM

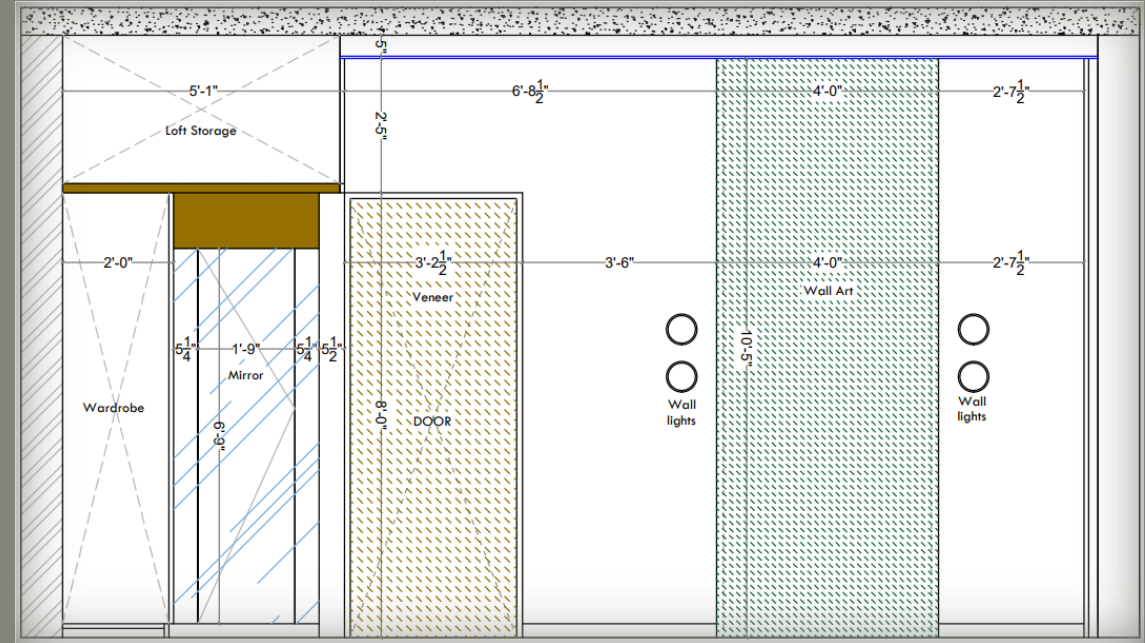
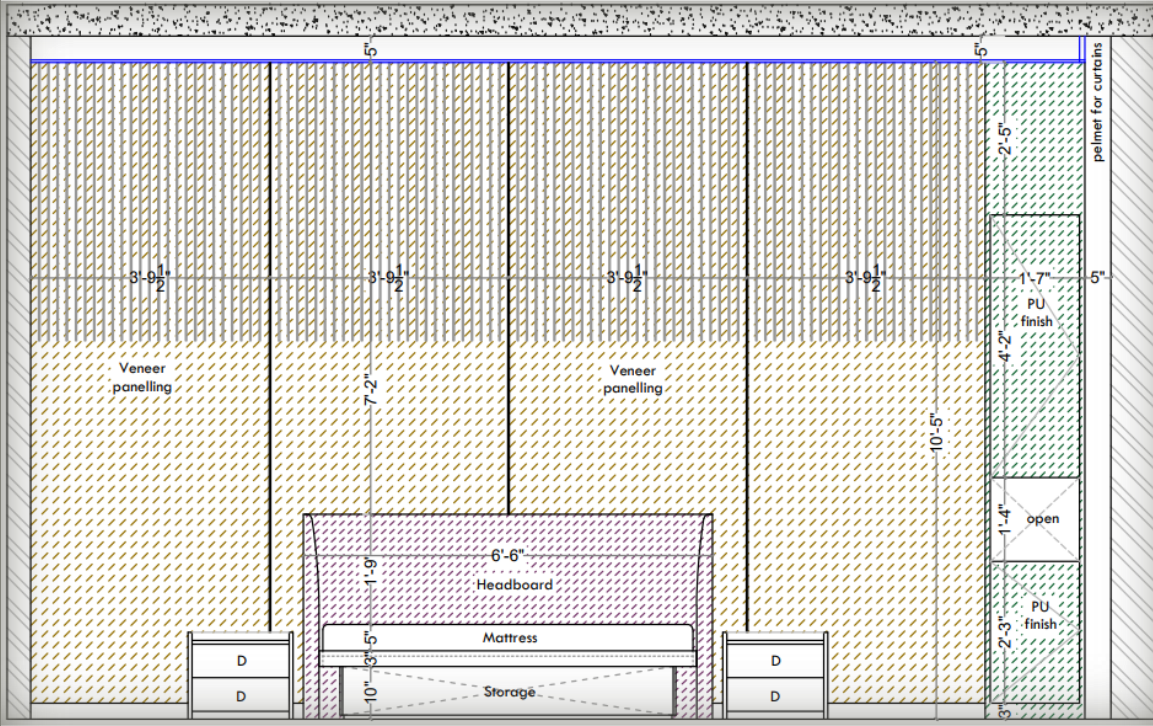

# MASTER BEDROOM



# MASTER BEDROOM



# MASTER BEDROOM



# MASTER BEDROOM

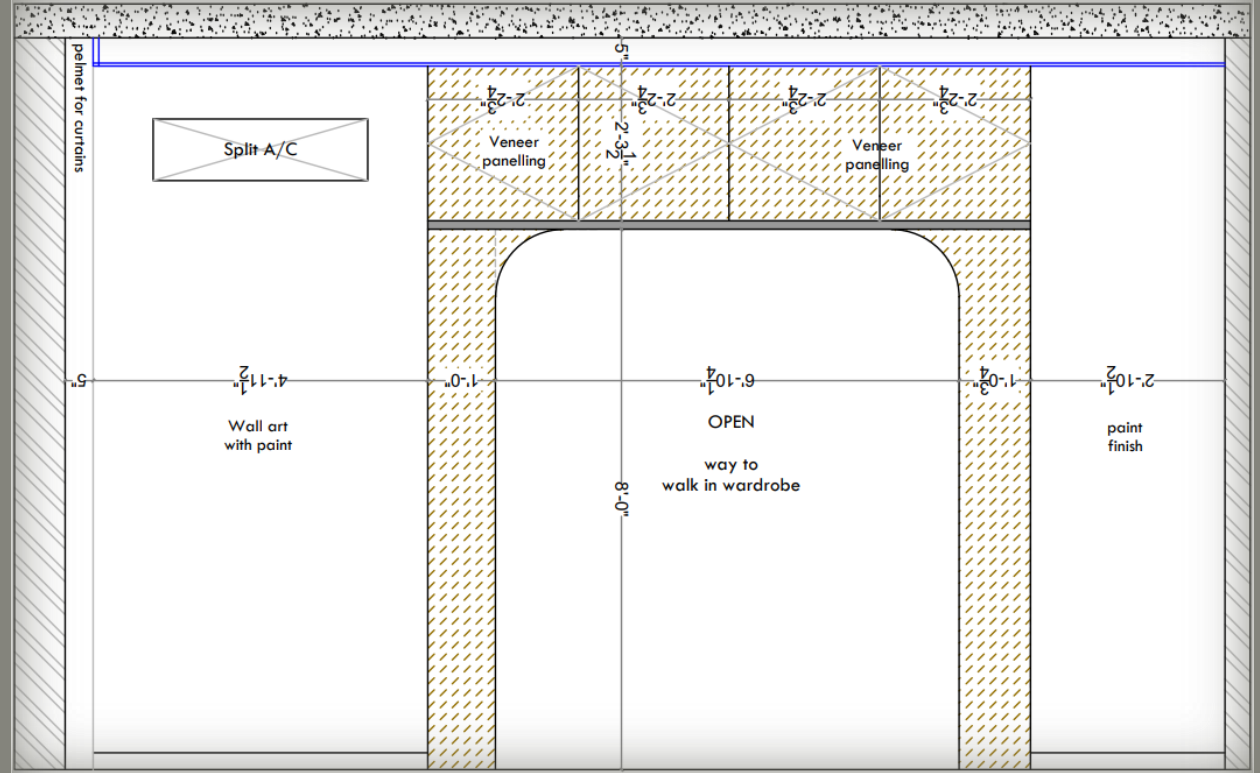
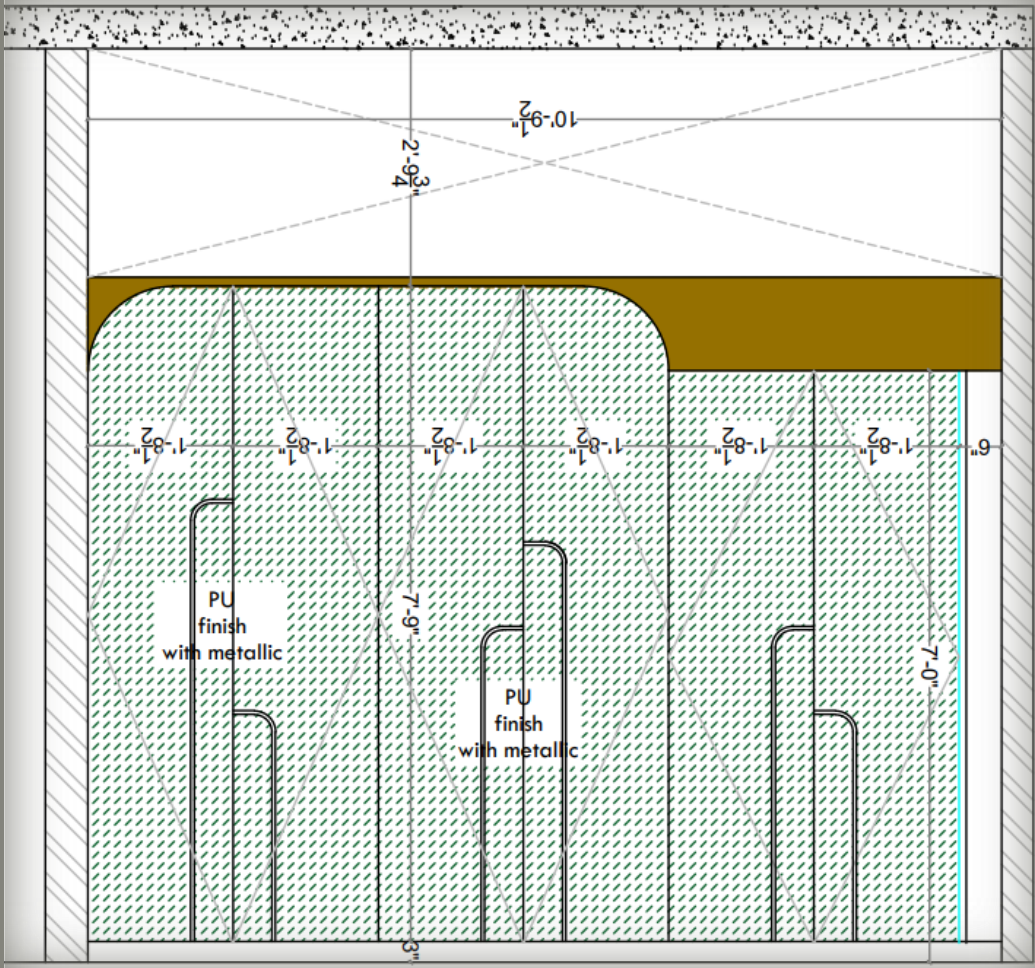

# MASTER BEDROOM



# MASTER BEDROOM



# MASTER BEDROOM

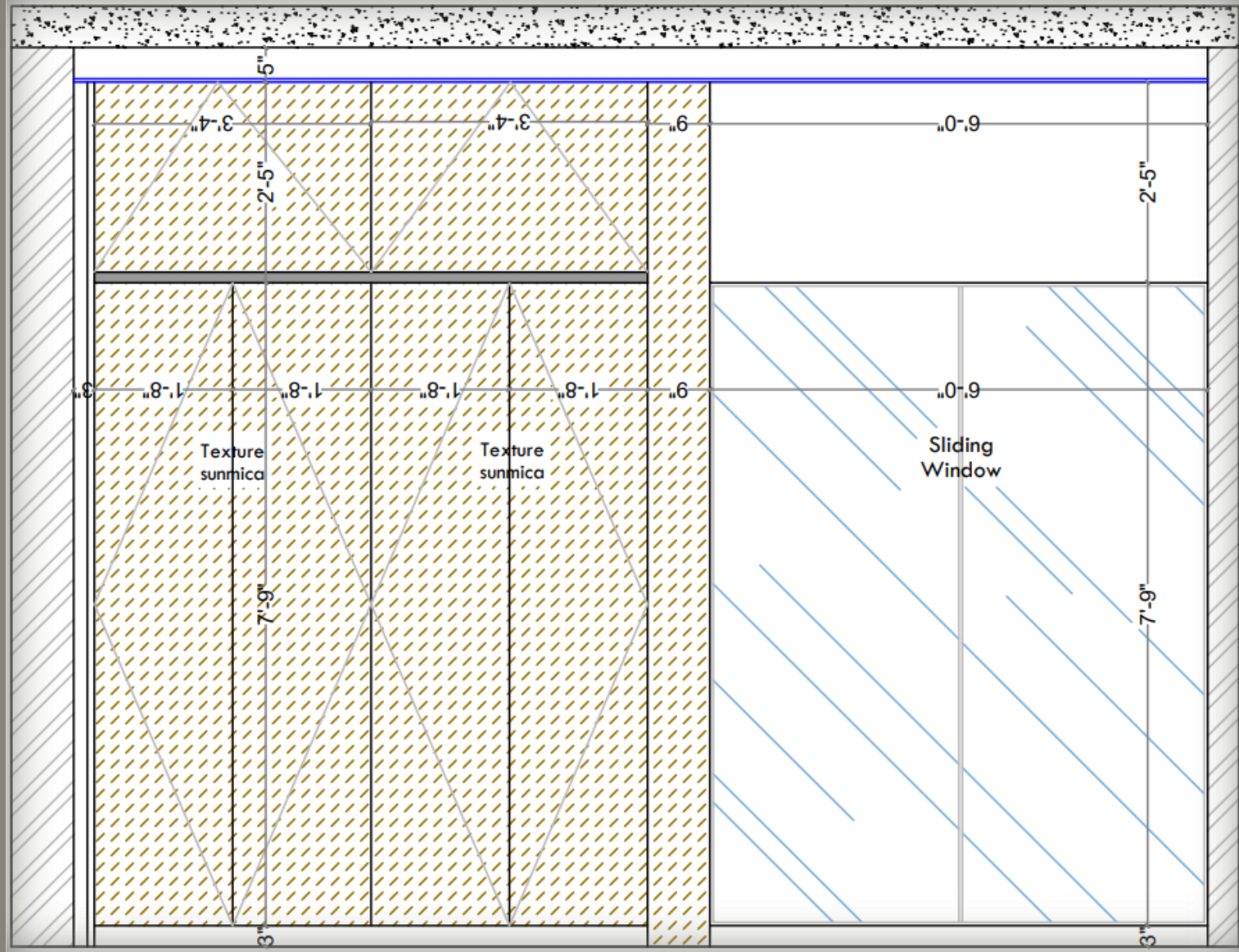

# MASTER BEDROOM



# MASTER BEDROOM



**MASTER BEDROOM  
OPTION-02**

# MASTER BEDROOM

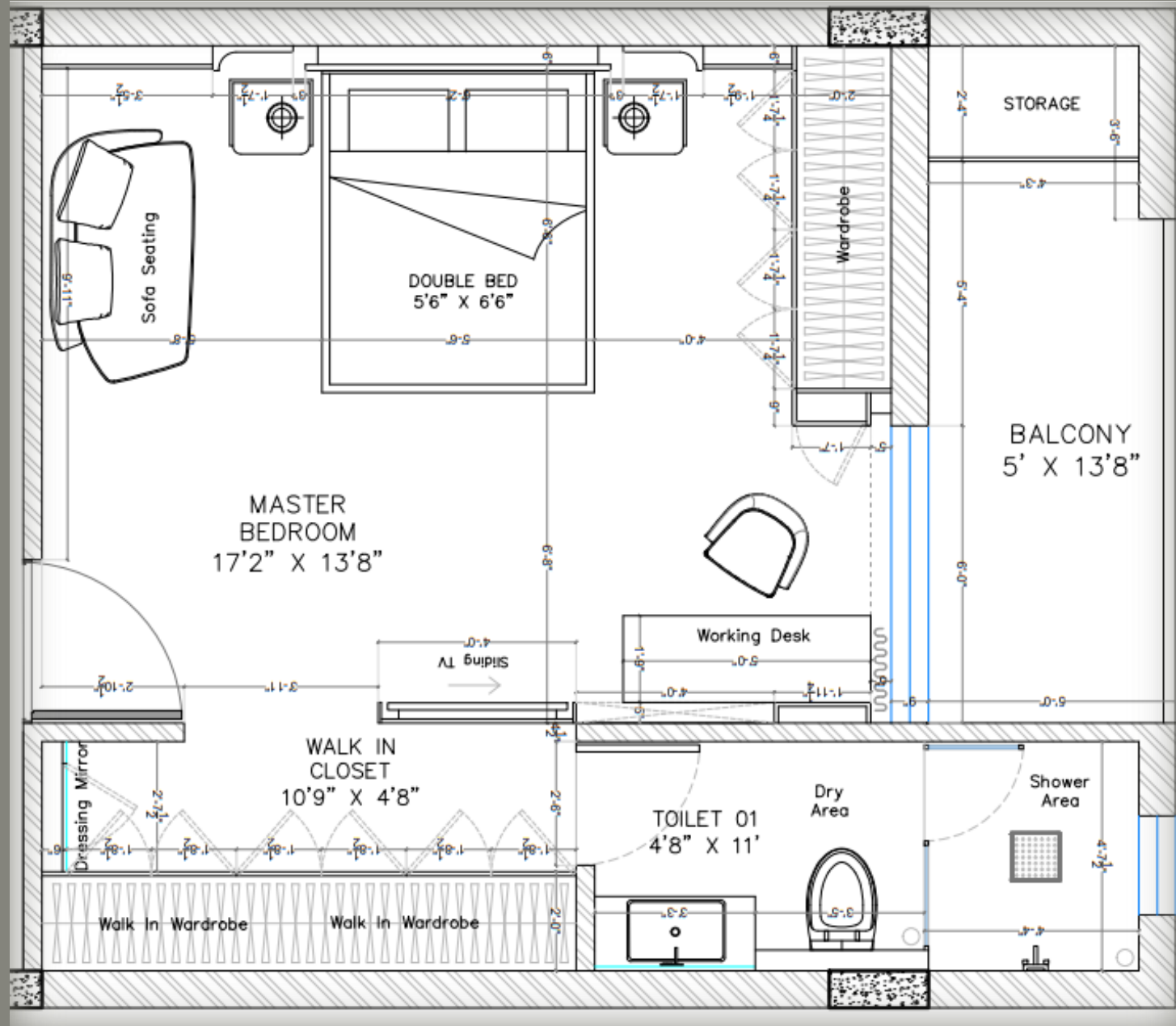

# MASTER BEDROOM

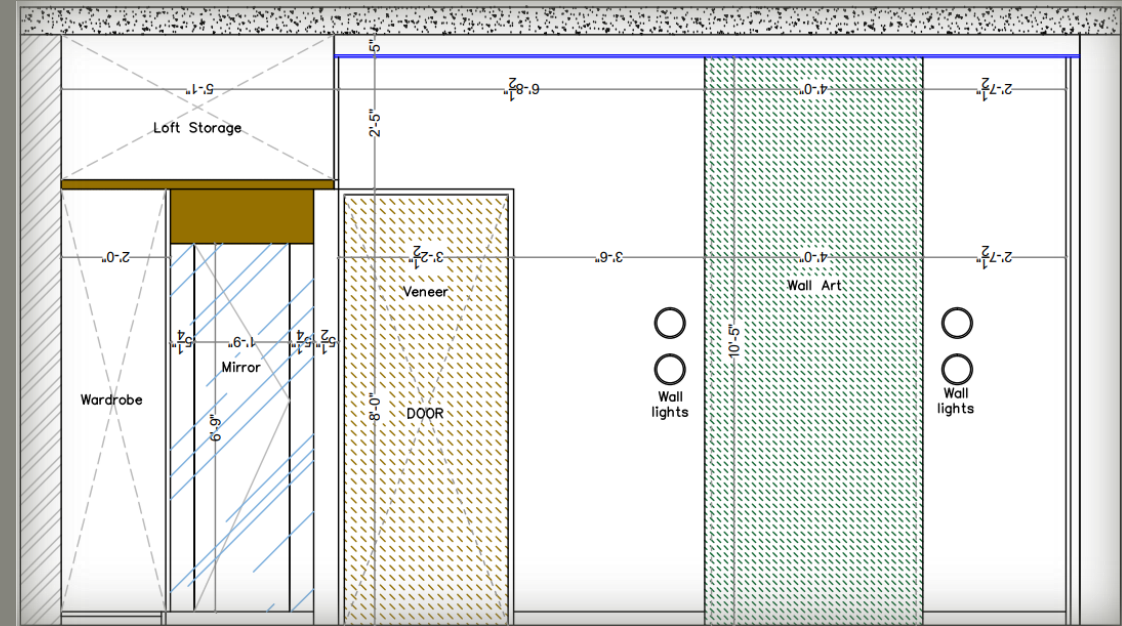
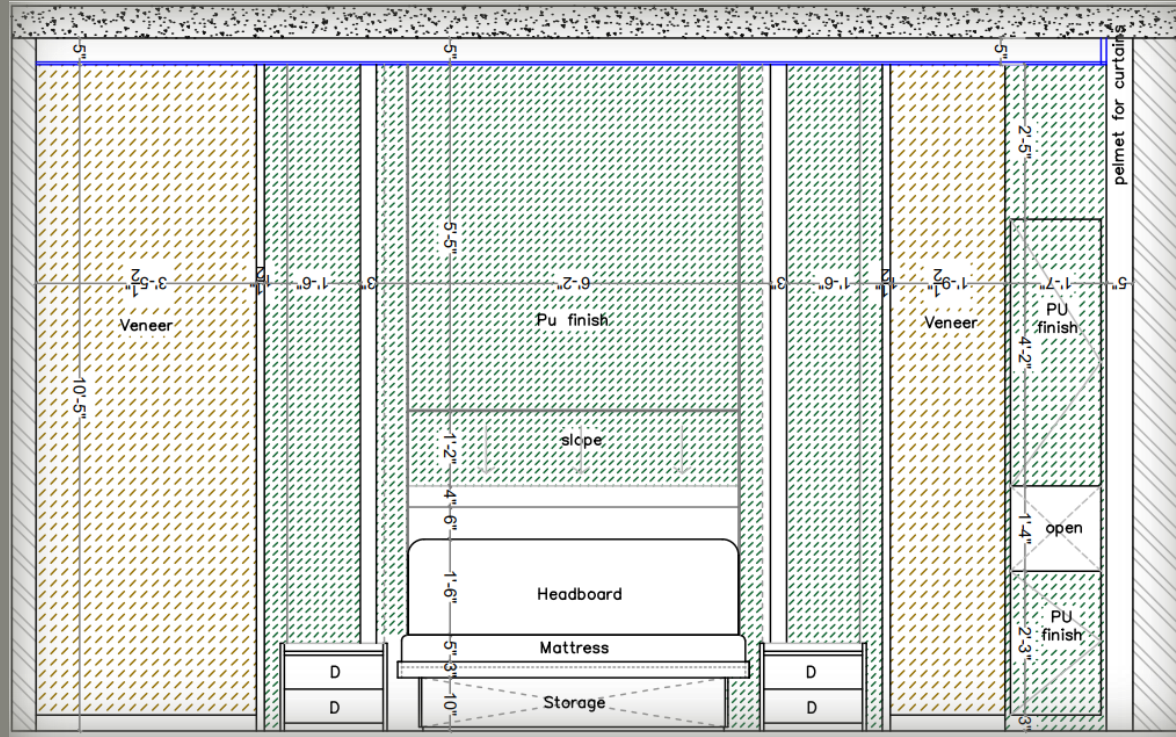

# MASTER BEDROOM



# MASTER BEDROOM



# MASTER BEDROOM

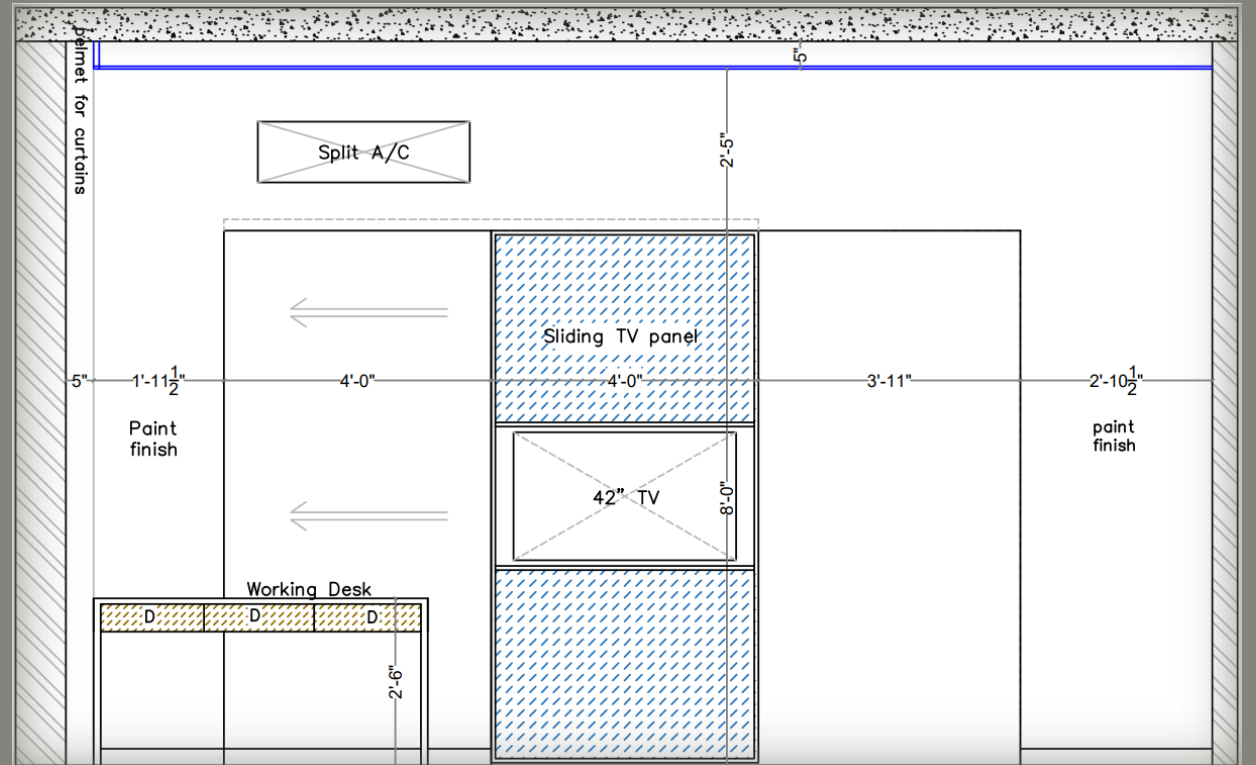
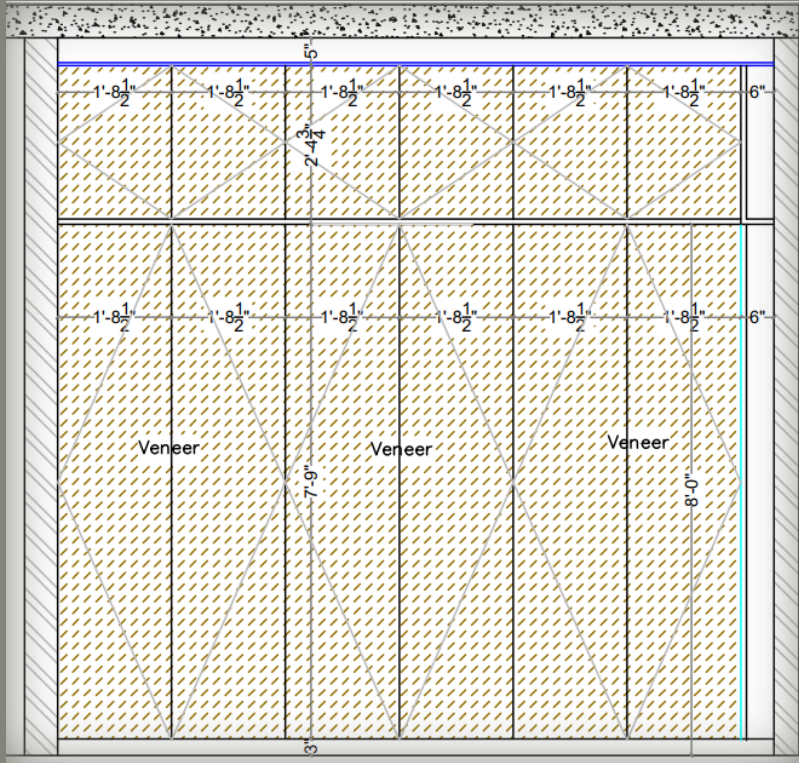

# MASTER BEDROOM



# MASTER BEDROOM

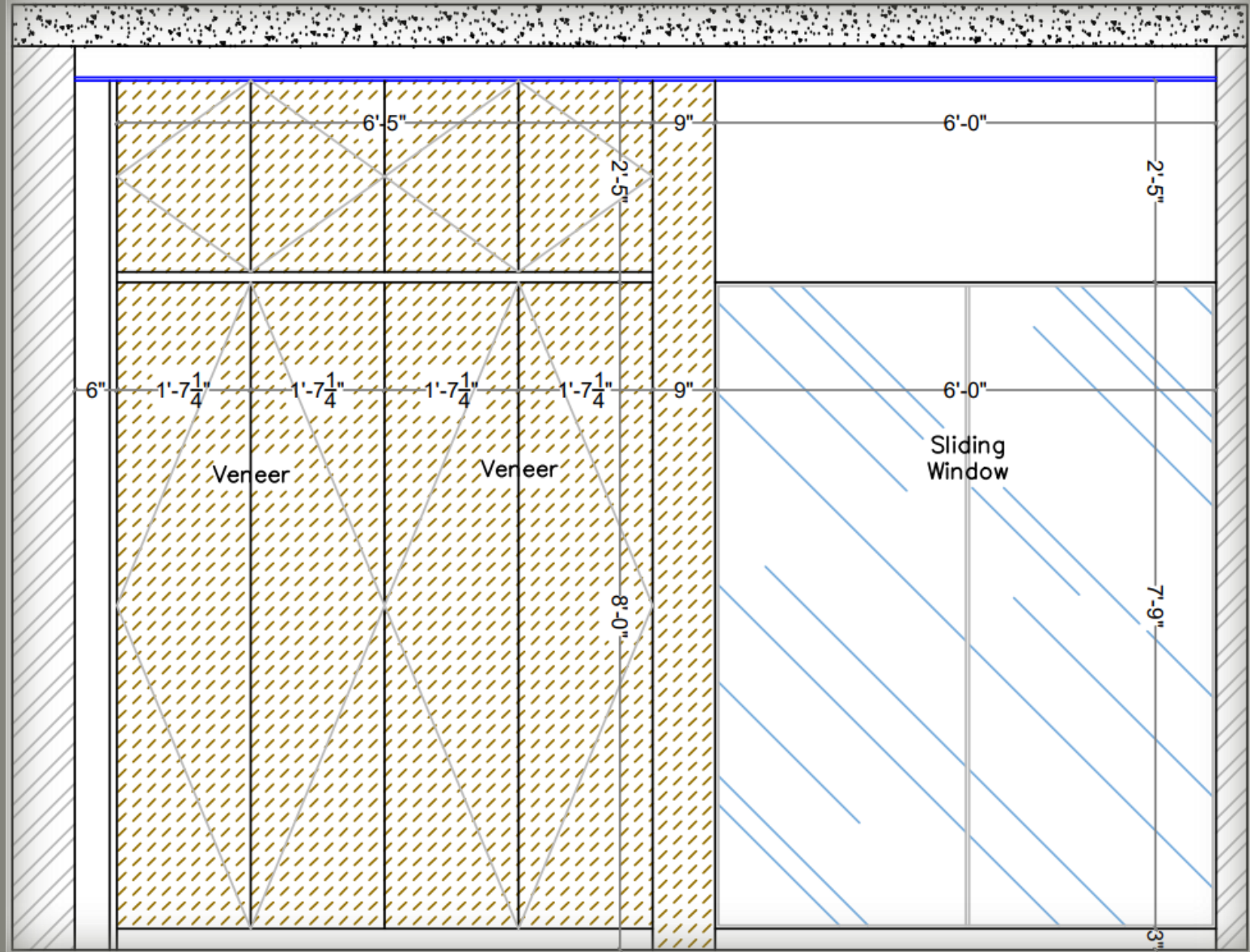

# MASTER BEDROOM



# MASTER BEDROOM

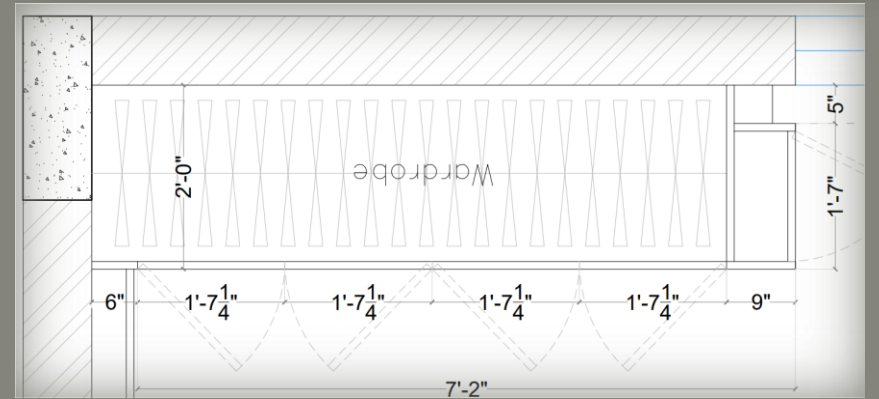
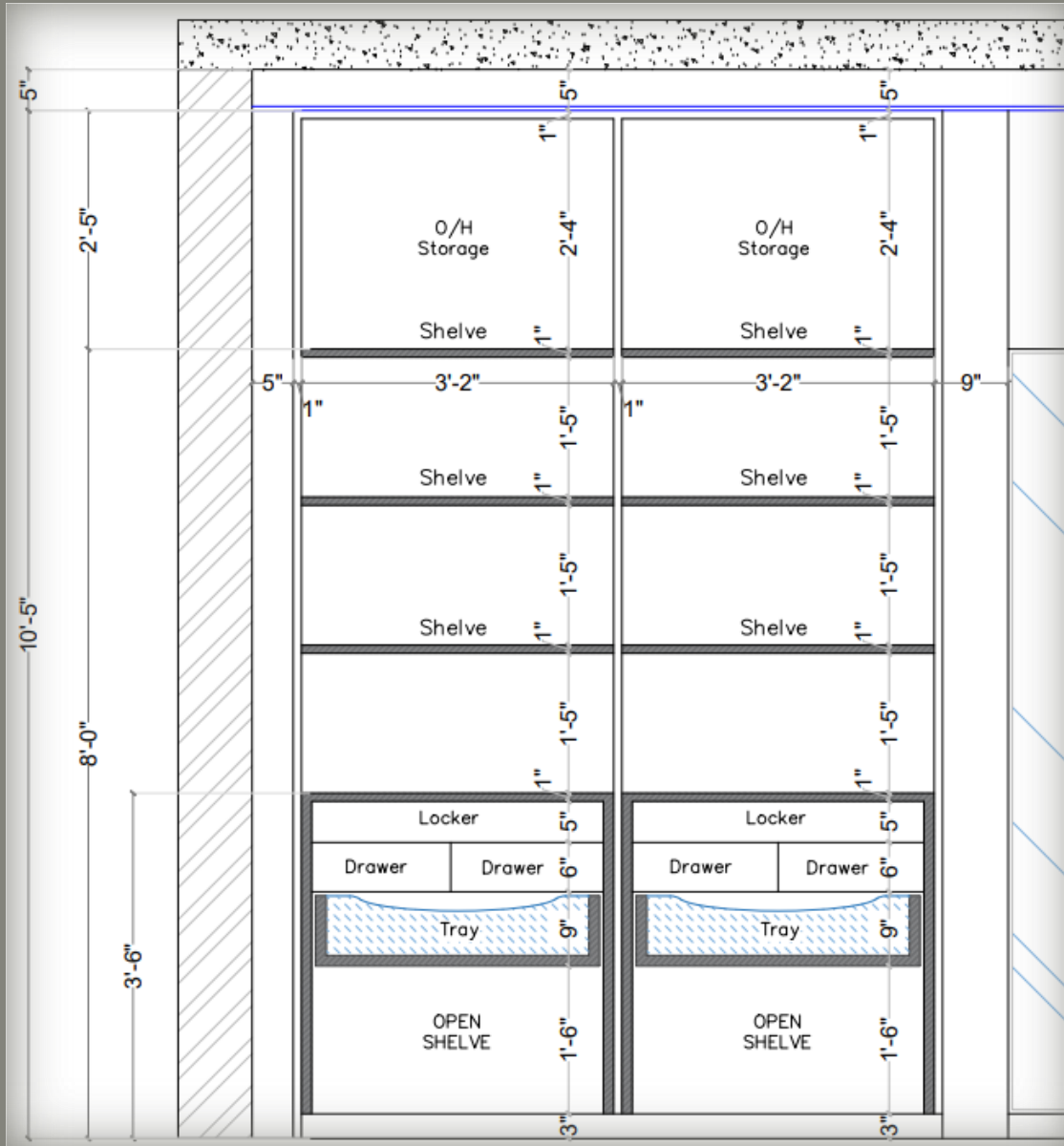

WARDROBE INTERNAL

# MASTER BEDROOM

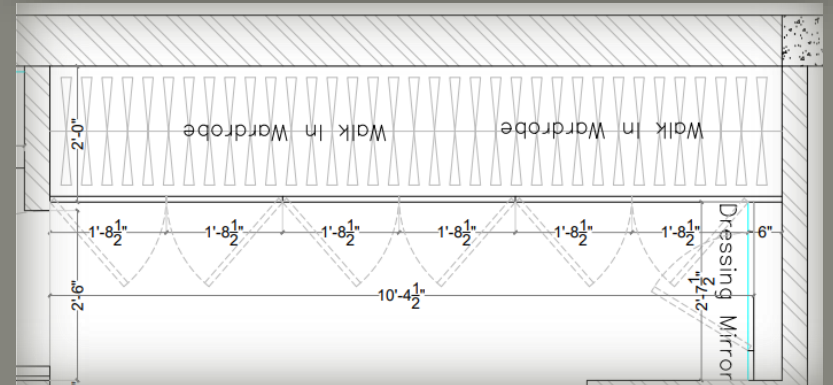
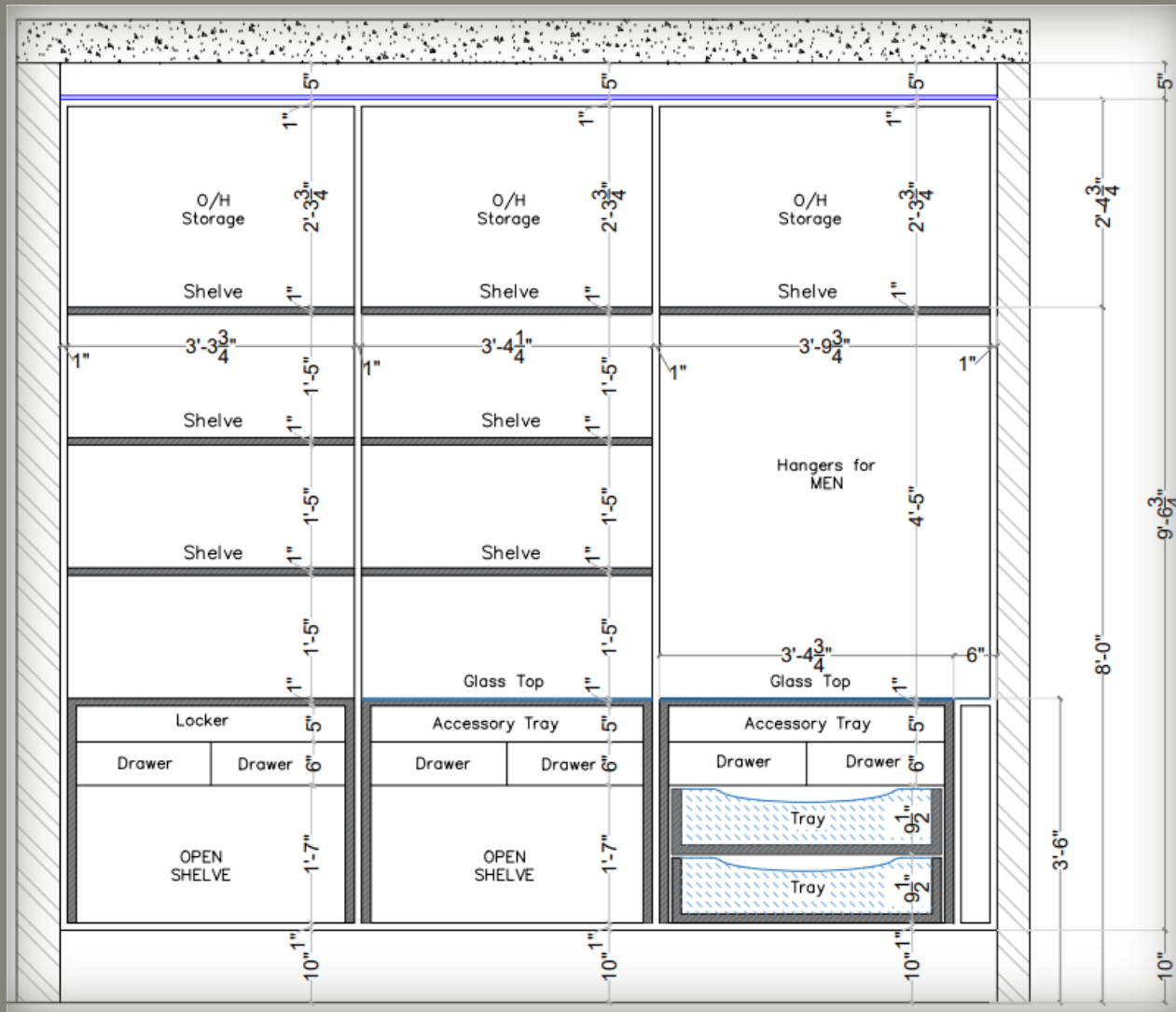

WARDROBE INTERNAL

# MASTER BEDROOM

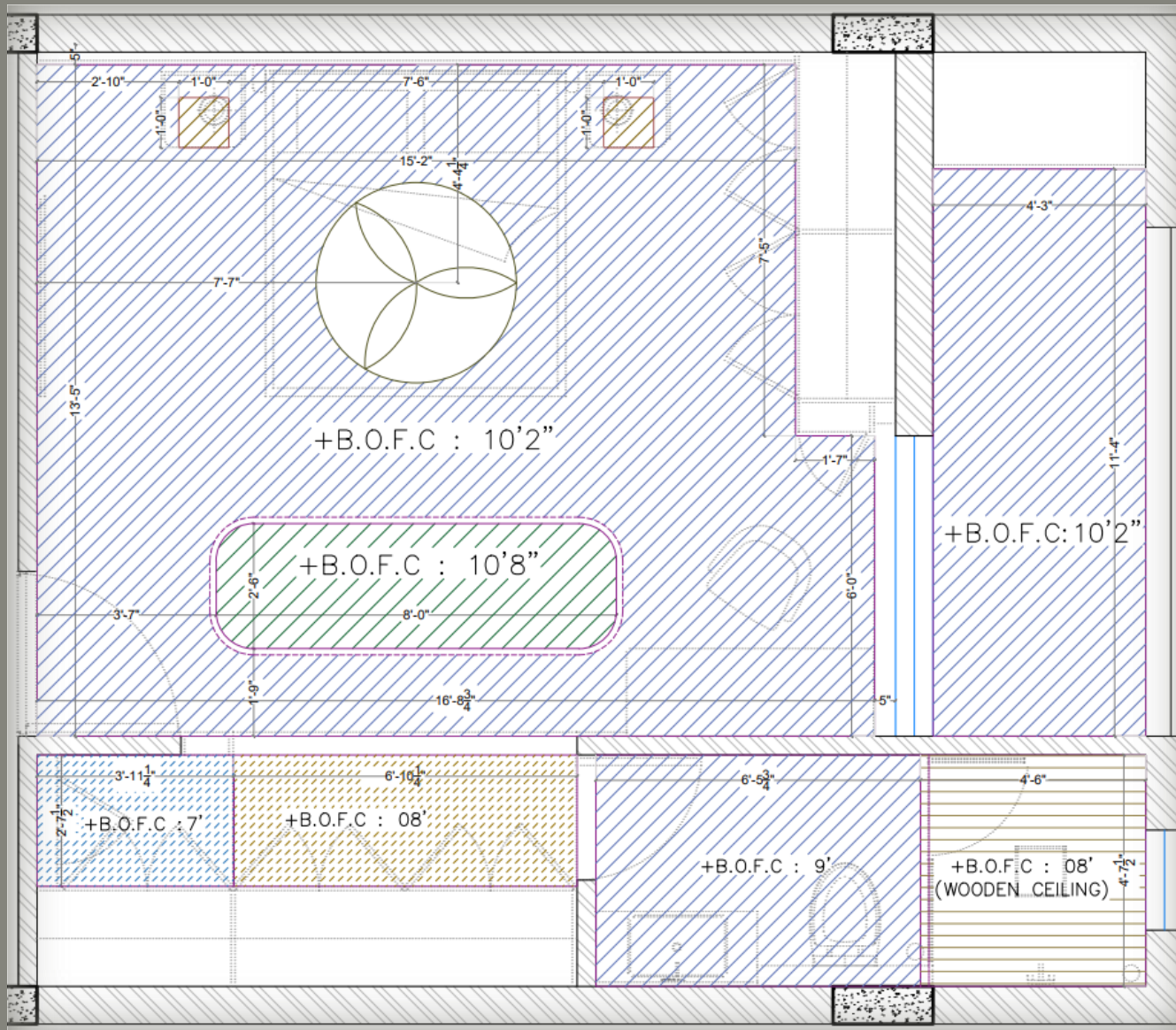

CEILING LAYOUT

# MASTER BEDROOM

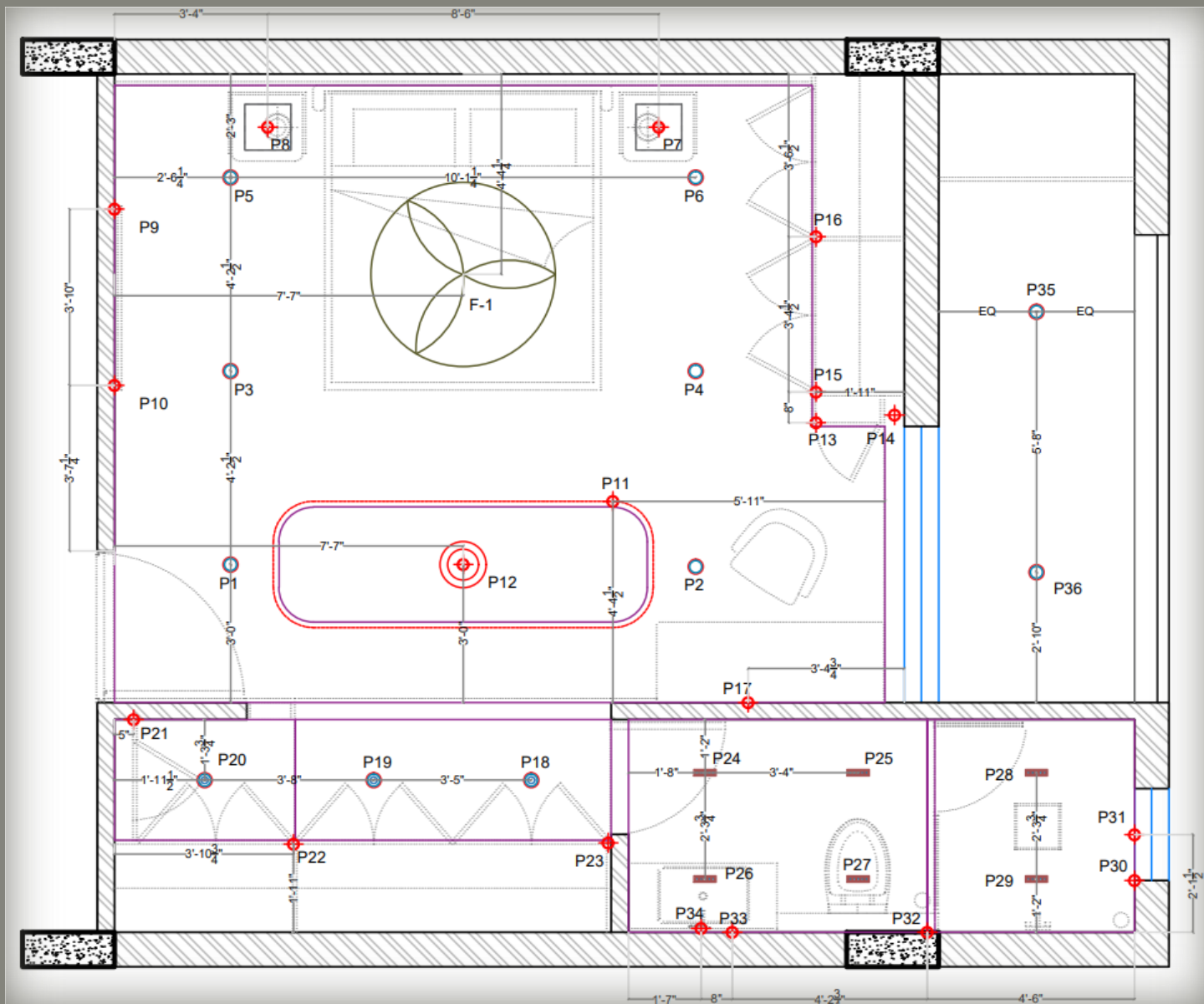

ELECTRICAL LAYOUT

# MASTER BEDROOM

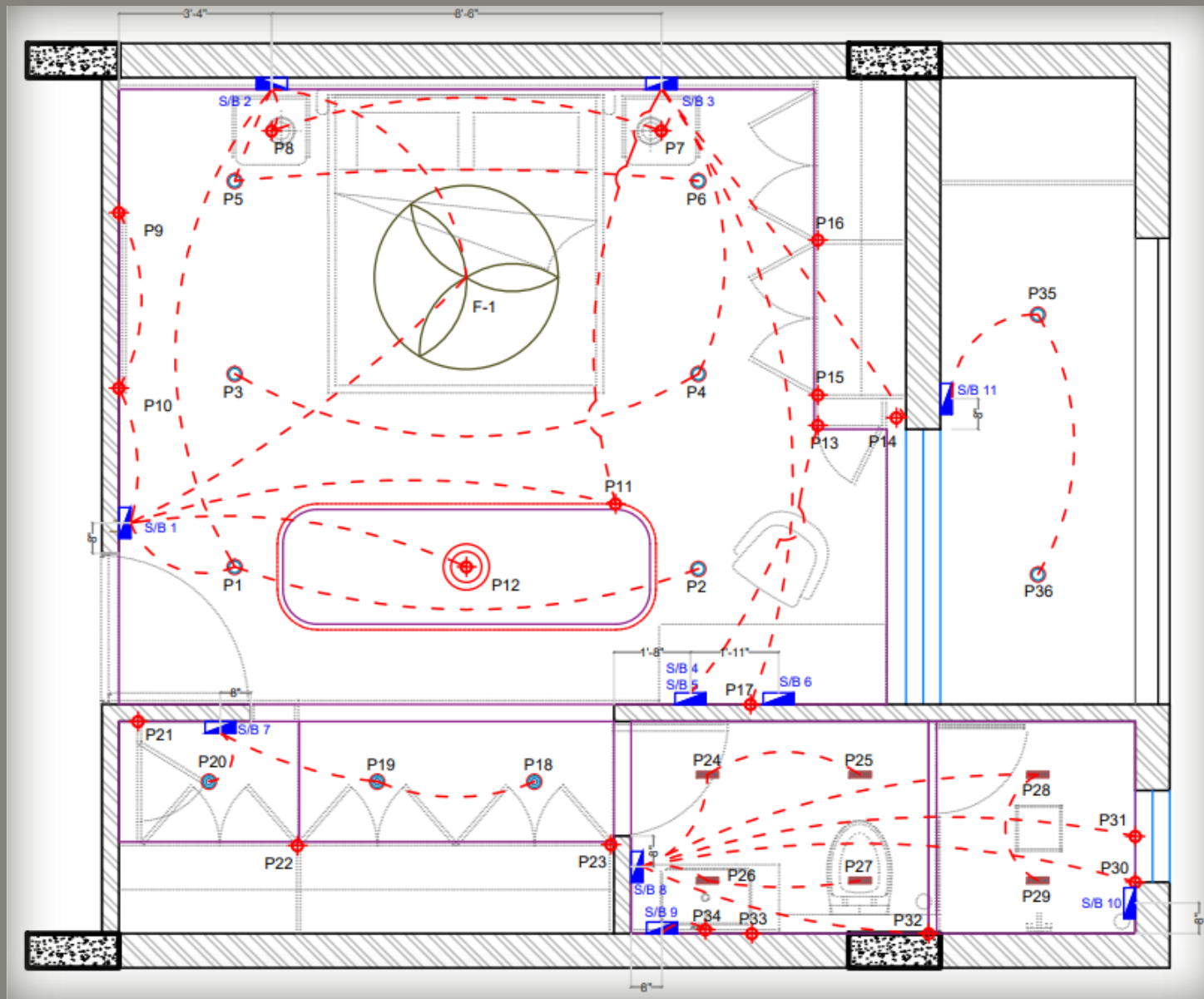

ELECTRICAL LOOPING LAYOUT

**MASTER BATHROOM**

# MASTER BATHROOM

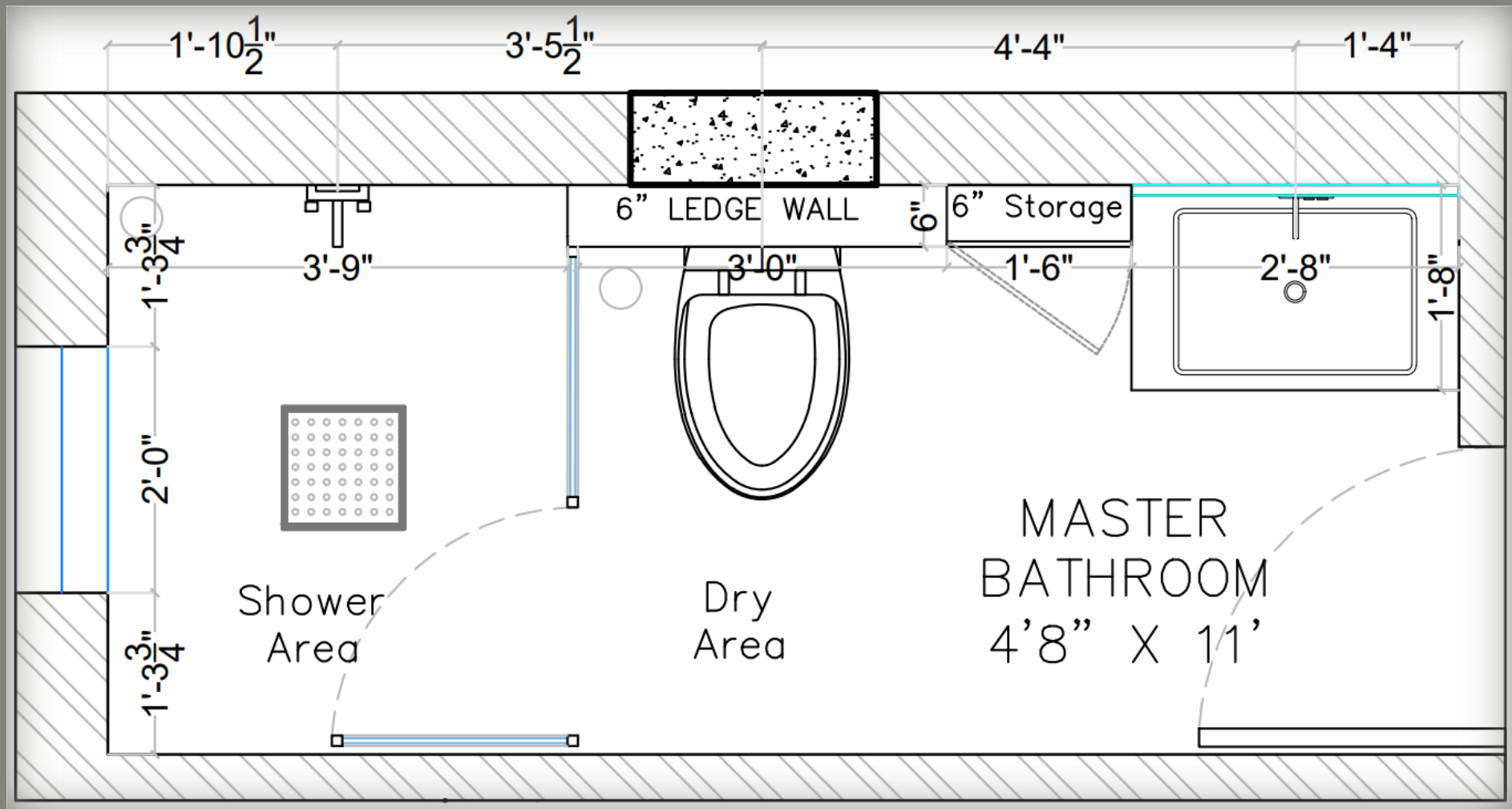

# MASTER BATHROOM

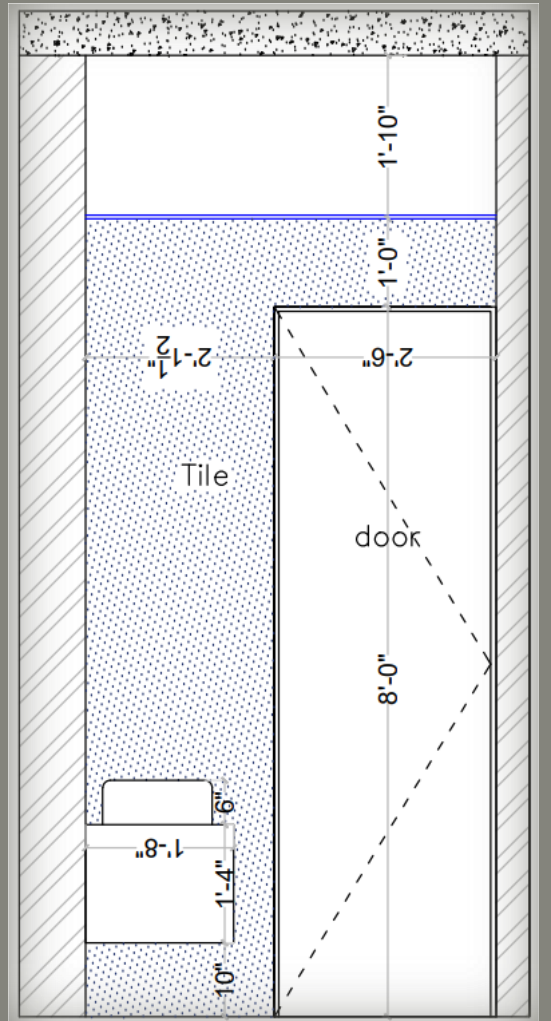
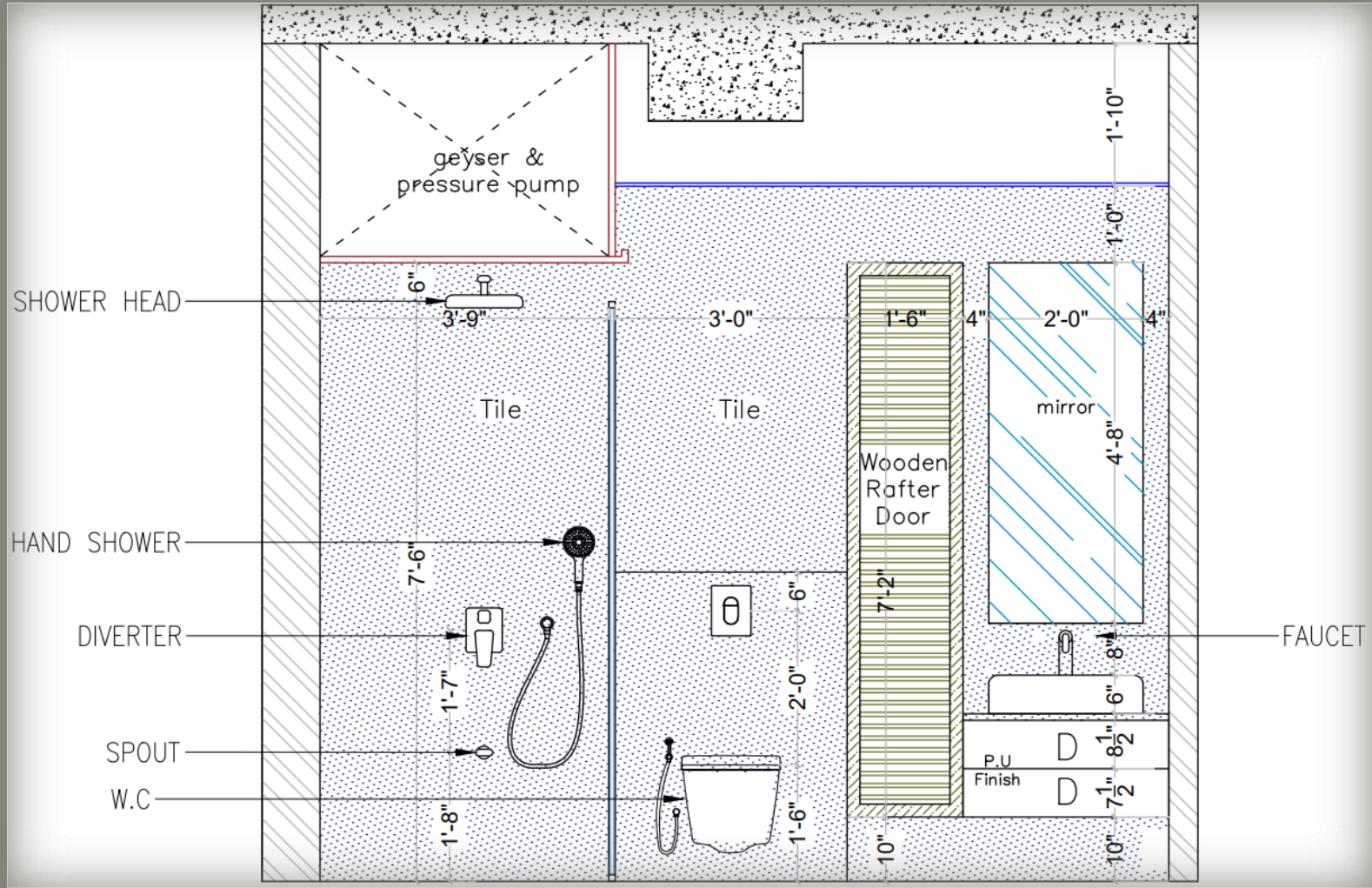

# MASTER BATHROOM

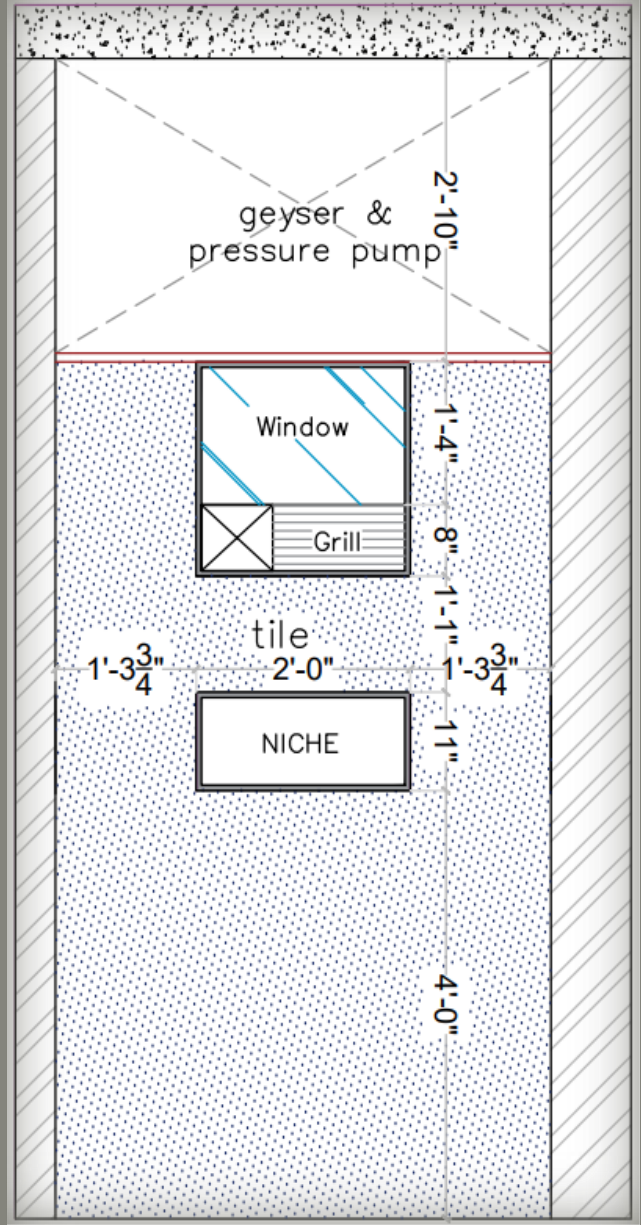
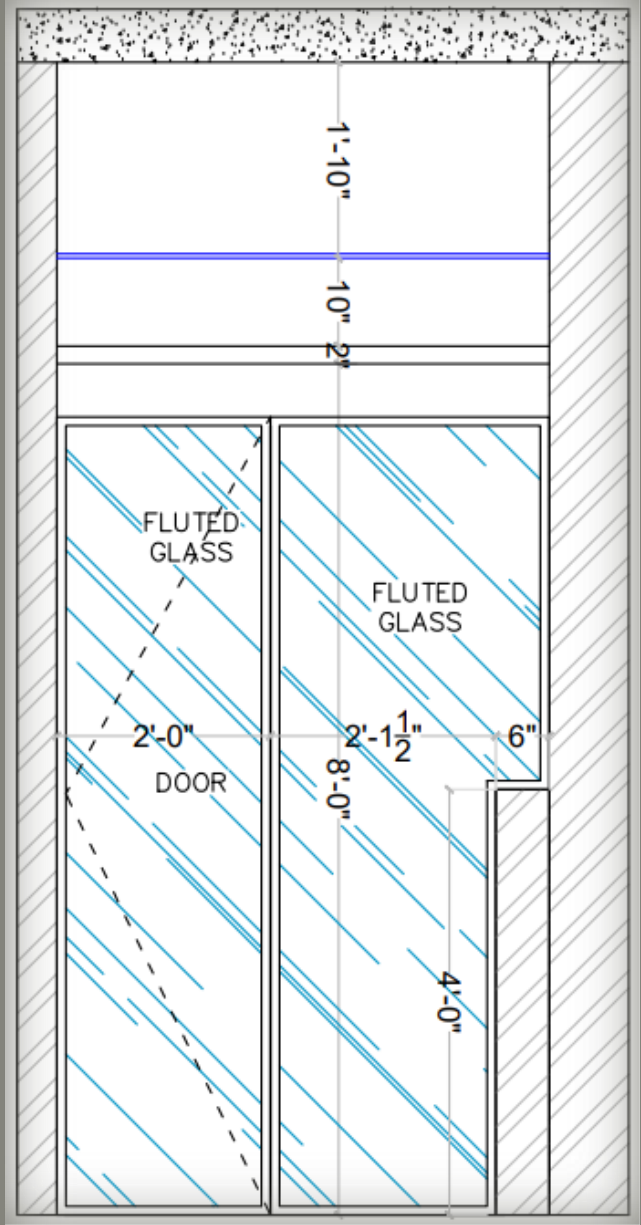

# MASTER BATHROOM



**GUEST BEDROOM**

# GUEST BEDROOM

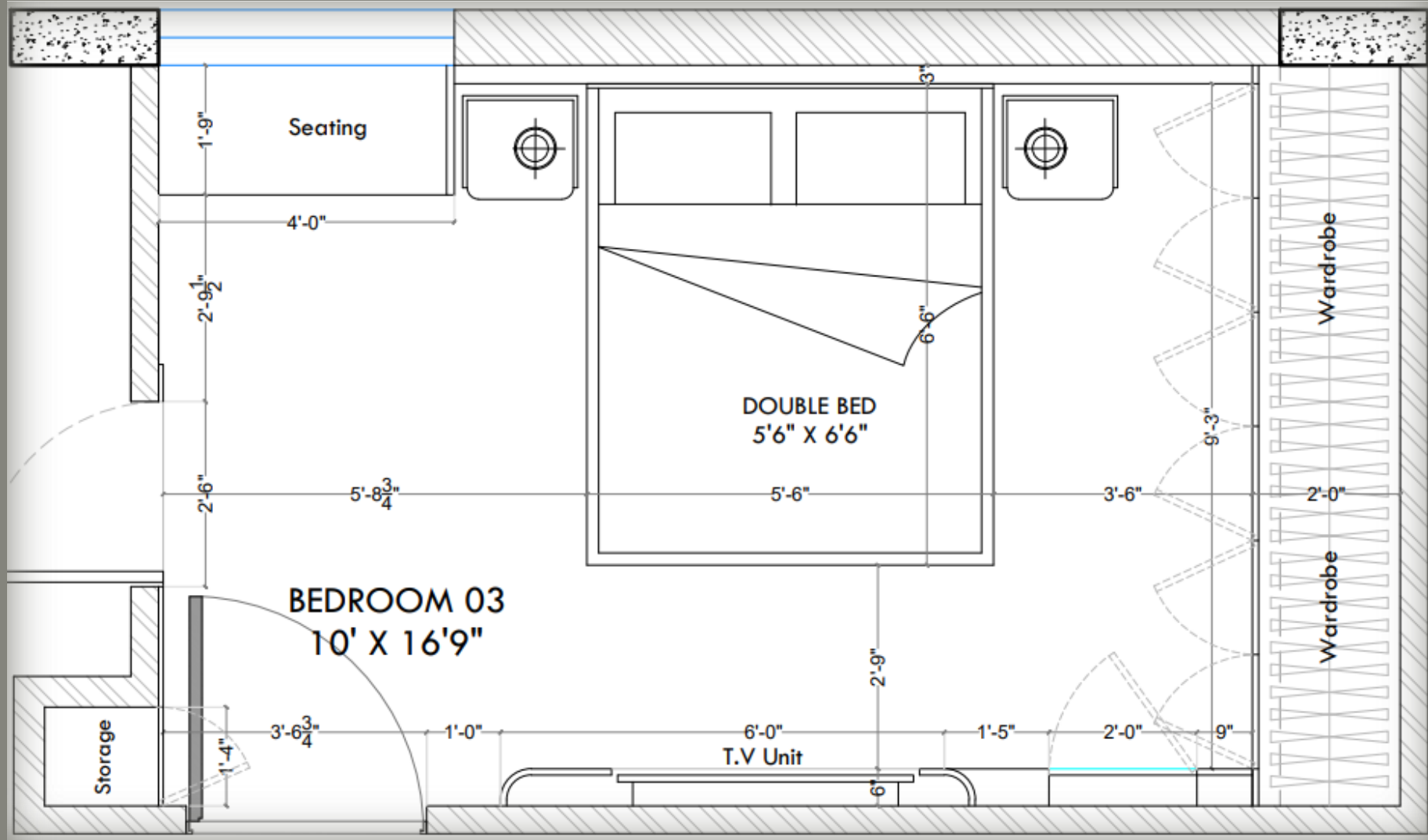

# GUEST BEDROOM

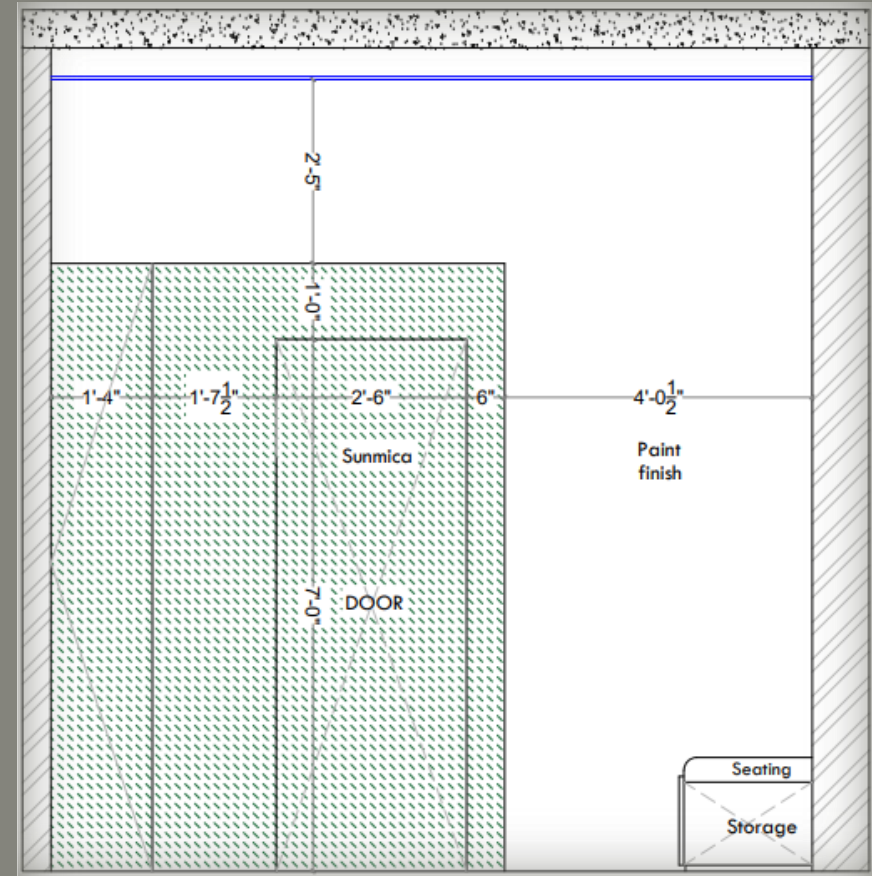
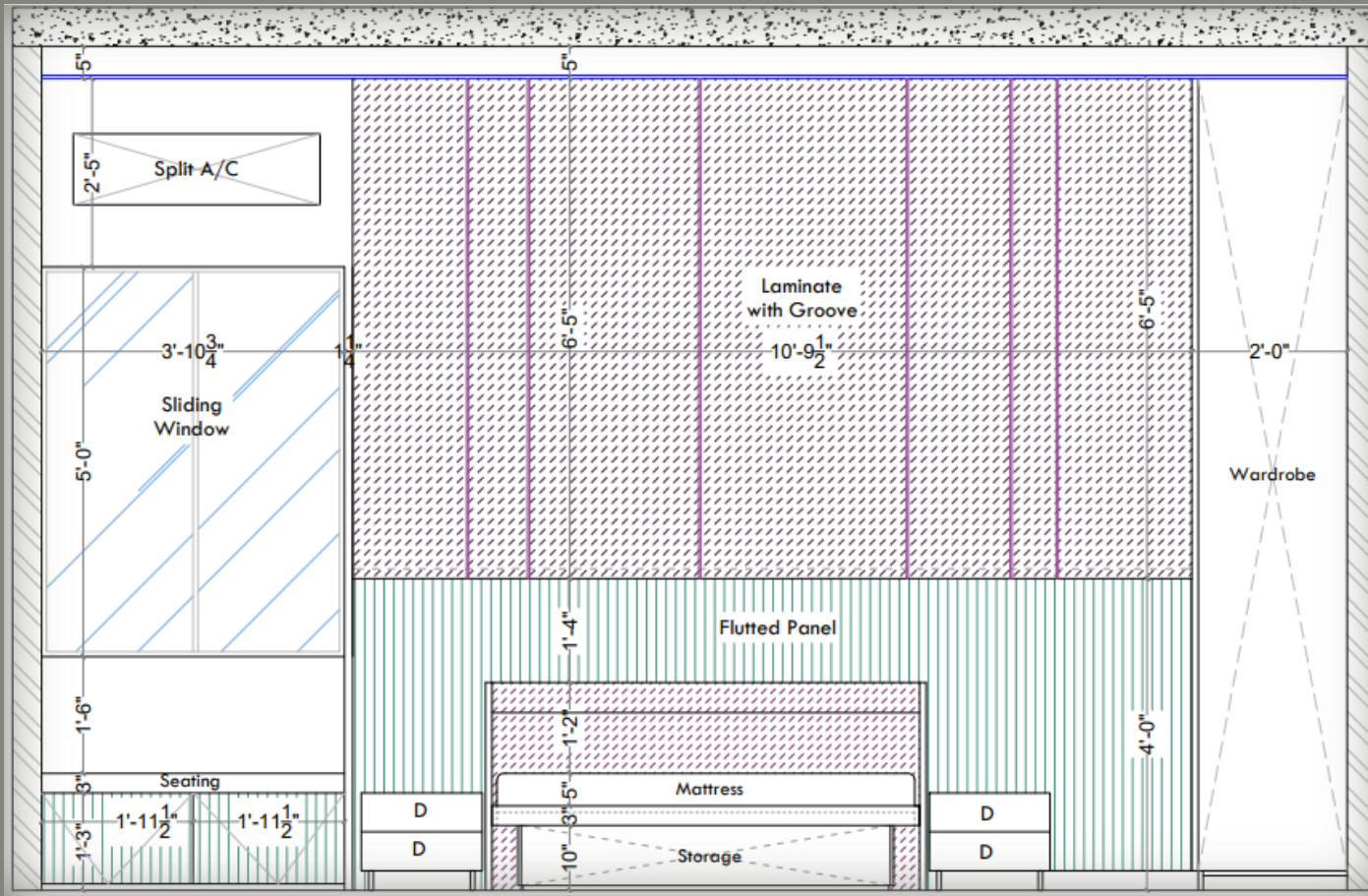

# GUEST BEDROOM



# GUEST BEDROOM



# GUEST BEDROOM

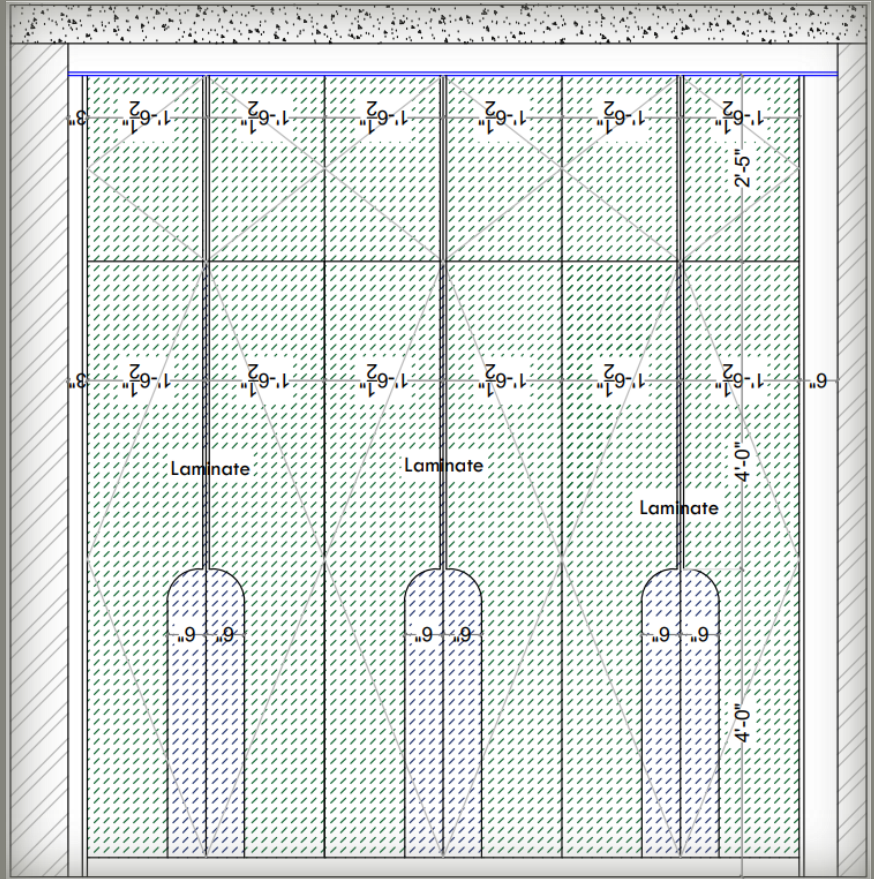
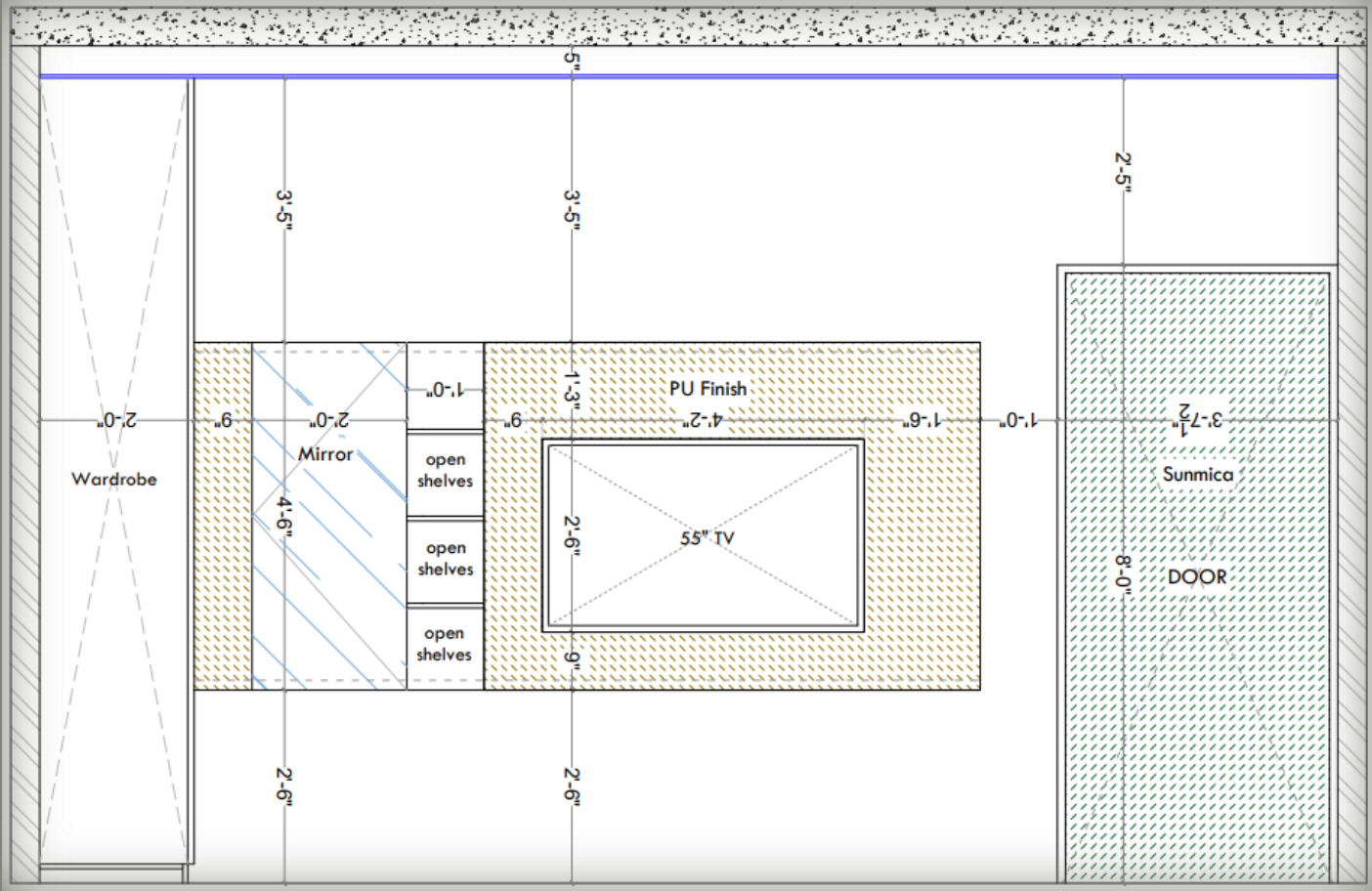

# GUEST BEDROOM



# GUEST BEDROOM



# GUEST BEDROOM

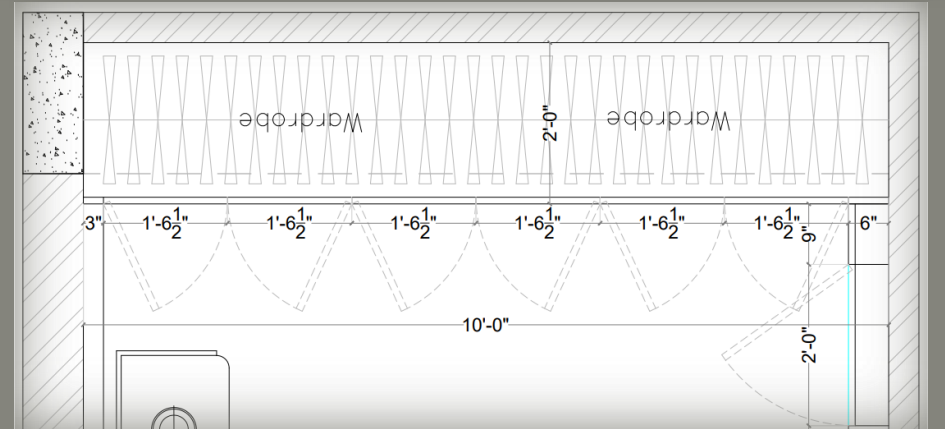
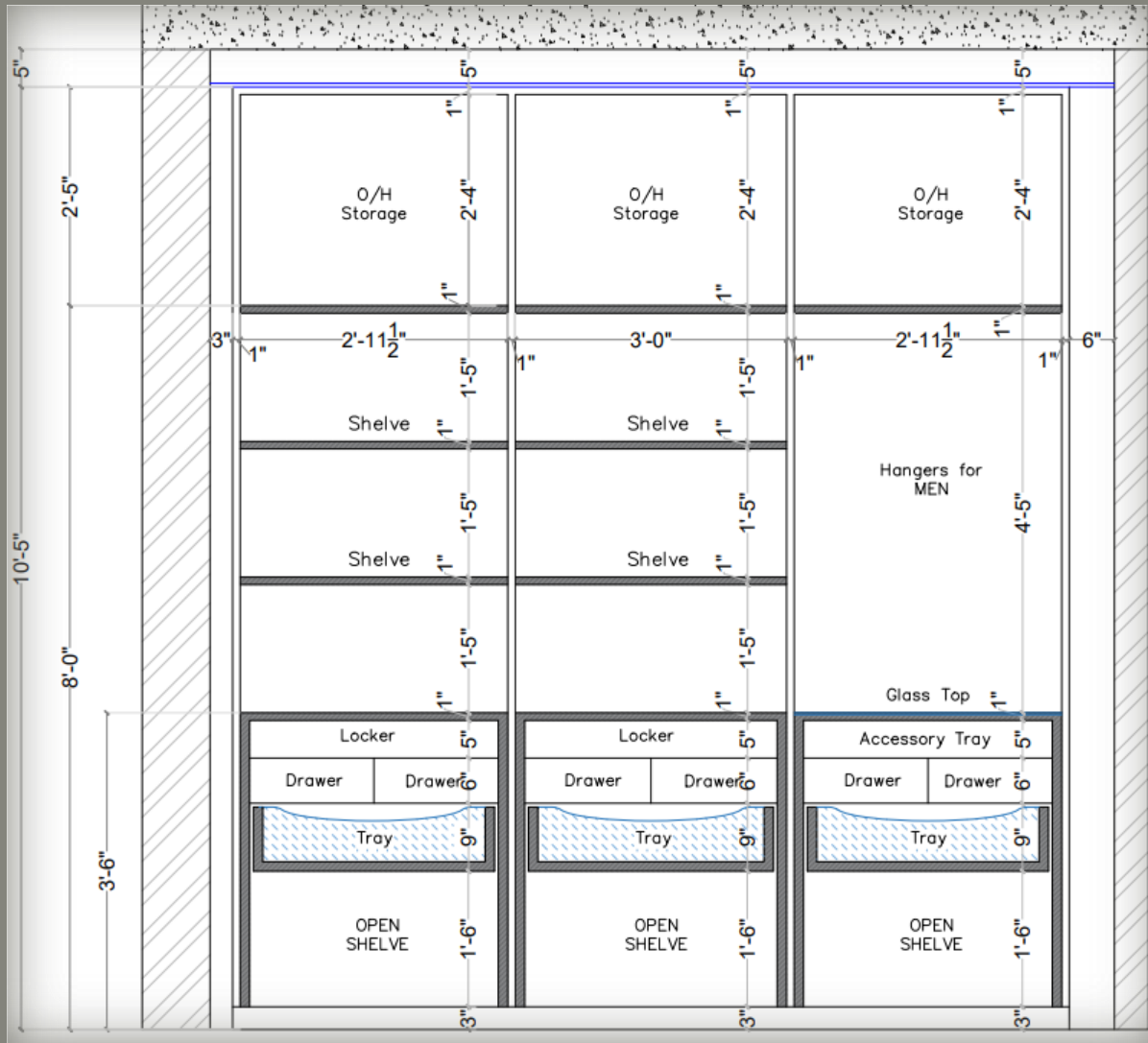

WARDROBE INTERNAL

# GUEST BEDROOM

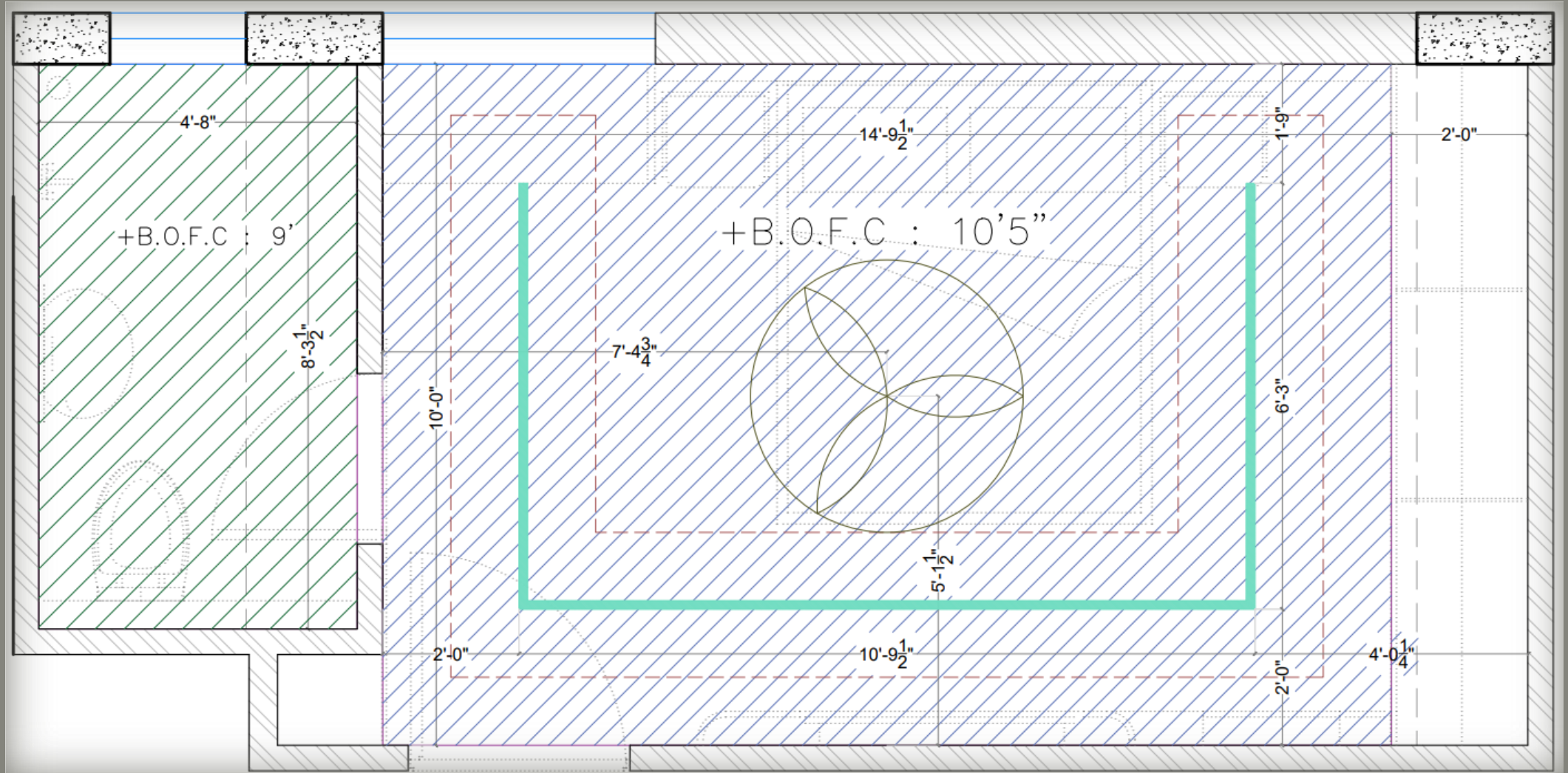

CEILING LAYOUT

# GUEST BEDROOM

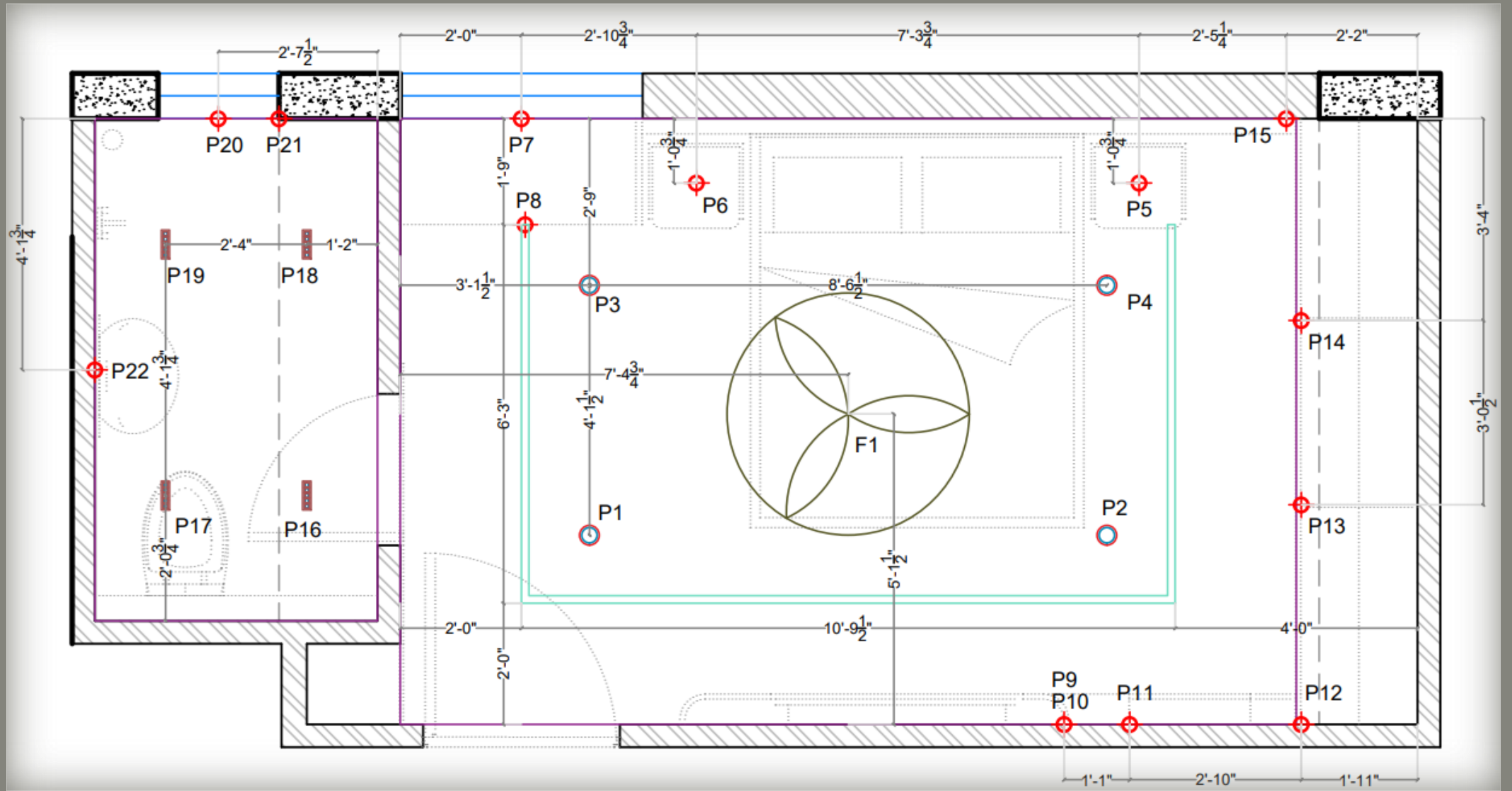

ELECTRICAL LAYOUT

# GUEST BEDROOM

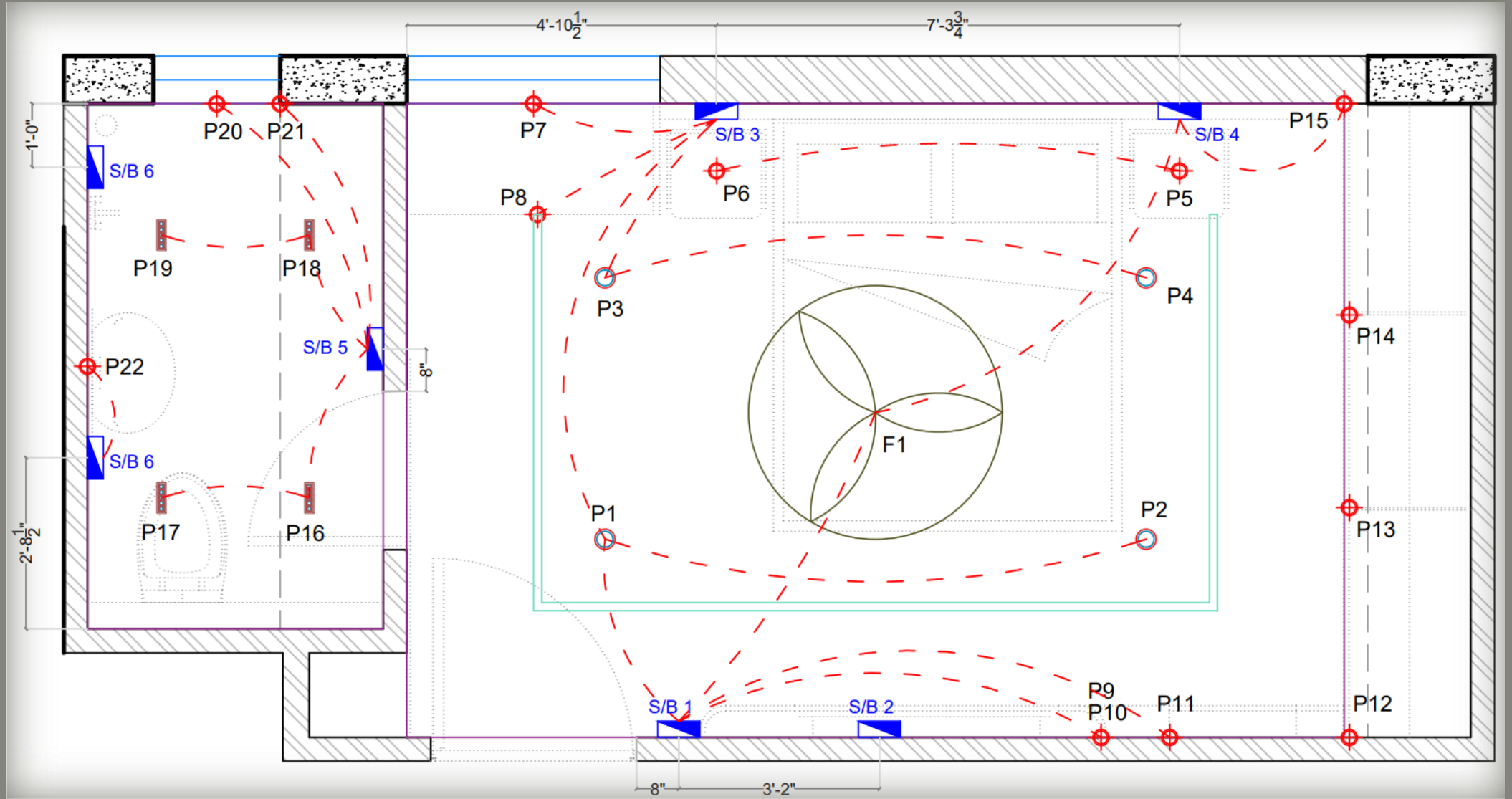

ELECTRICAL LOOPING LAYOUT

GUEST BATHROOM

# GUEST BATHROOM

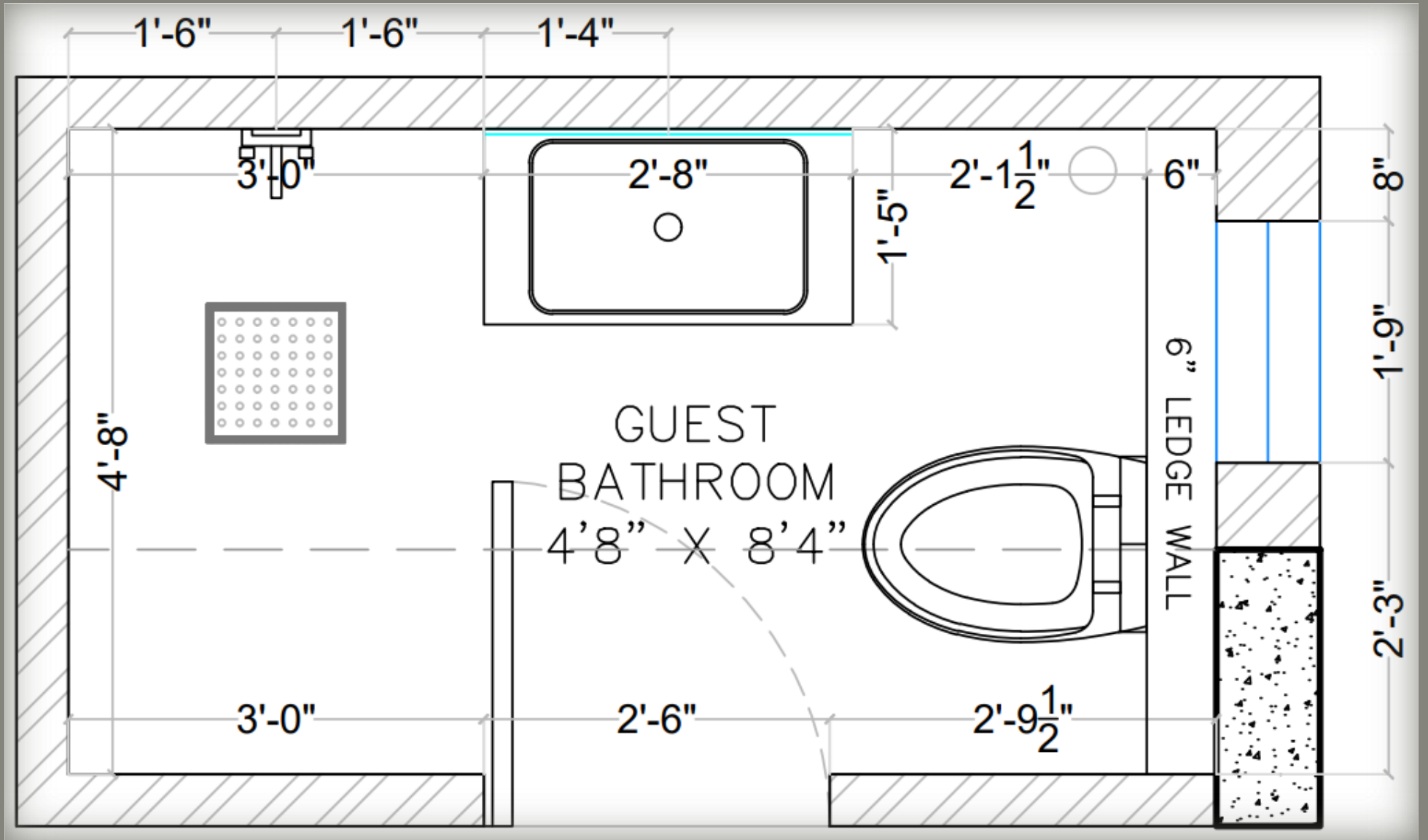

# GUEST BATHROOM

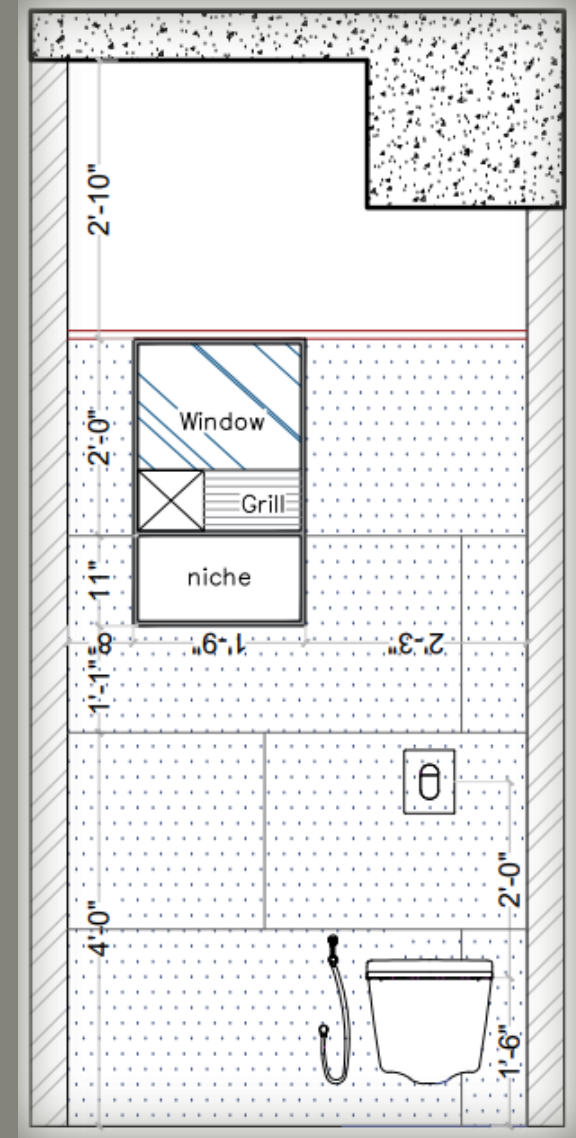
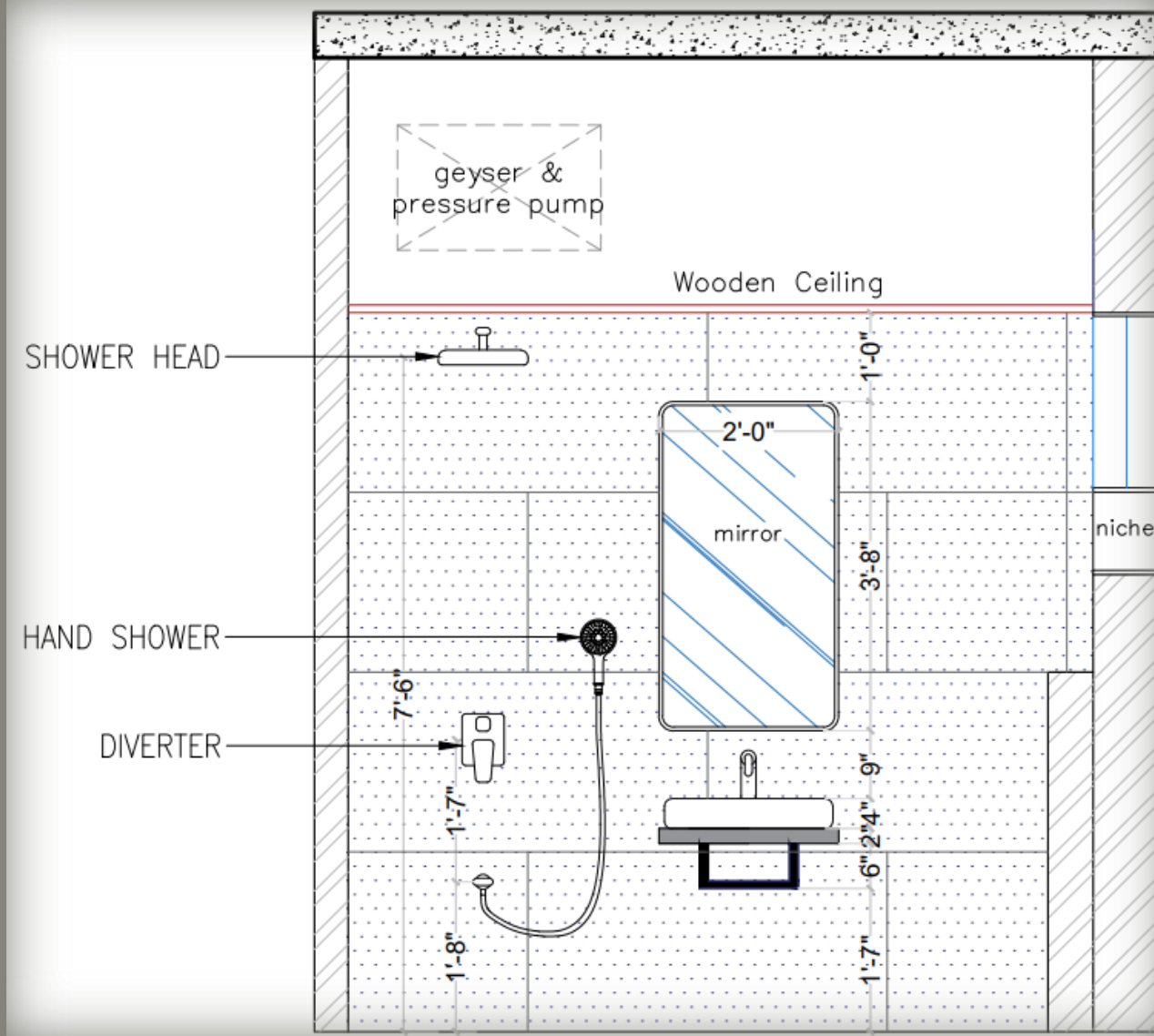

# GUEST BATHROOM

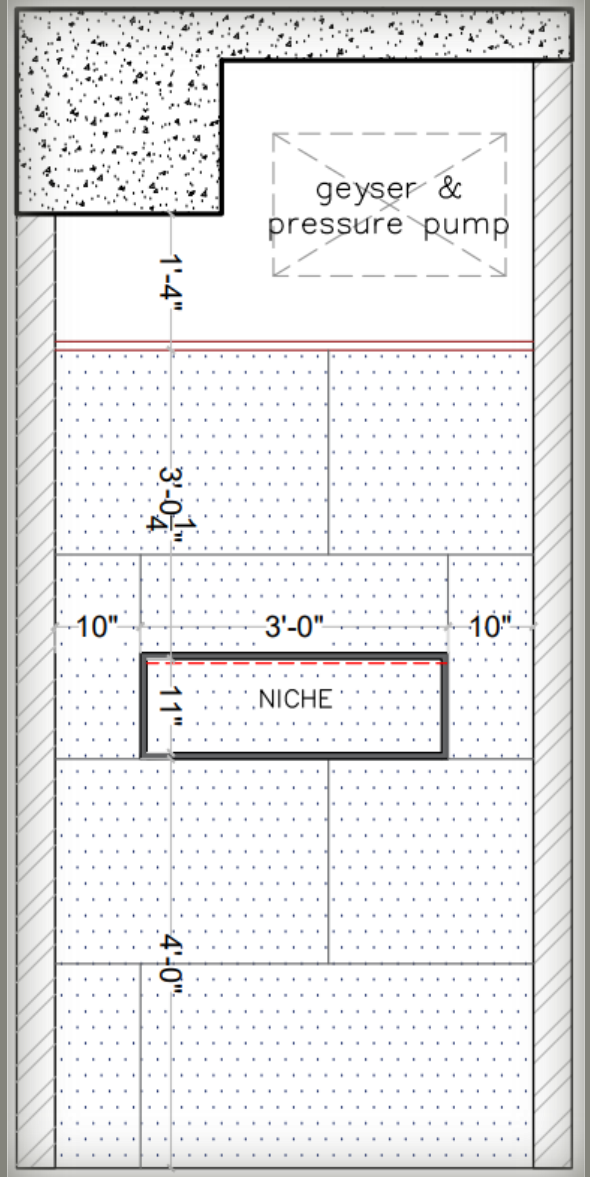
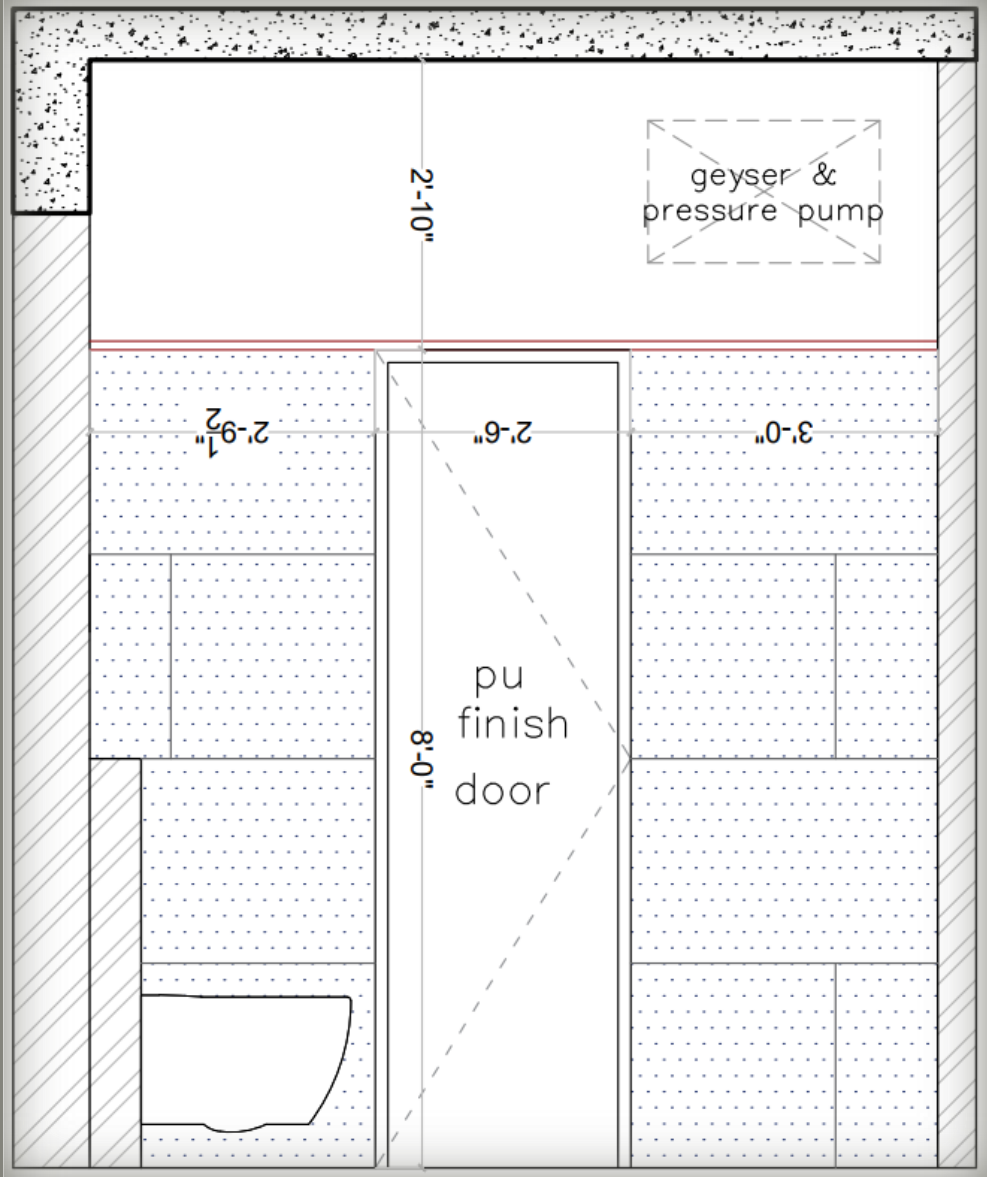

# GUEST BATHROOM



**CHILDREN BEDROOM  
OPTION-01**

# CHILDREN BEDROOM

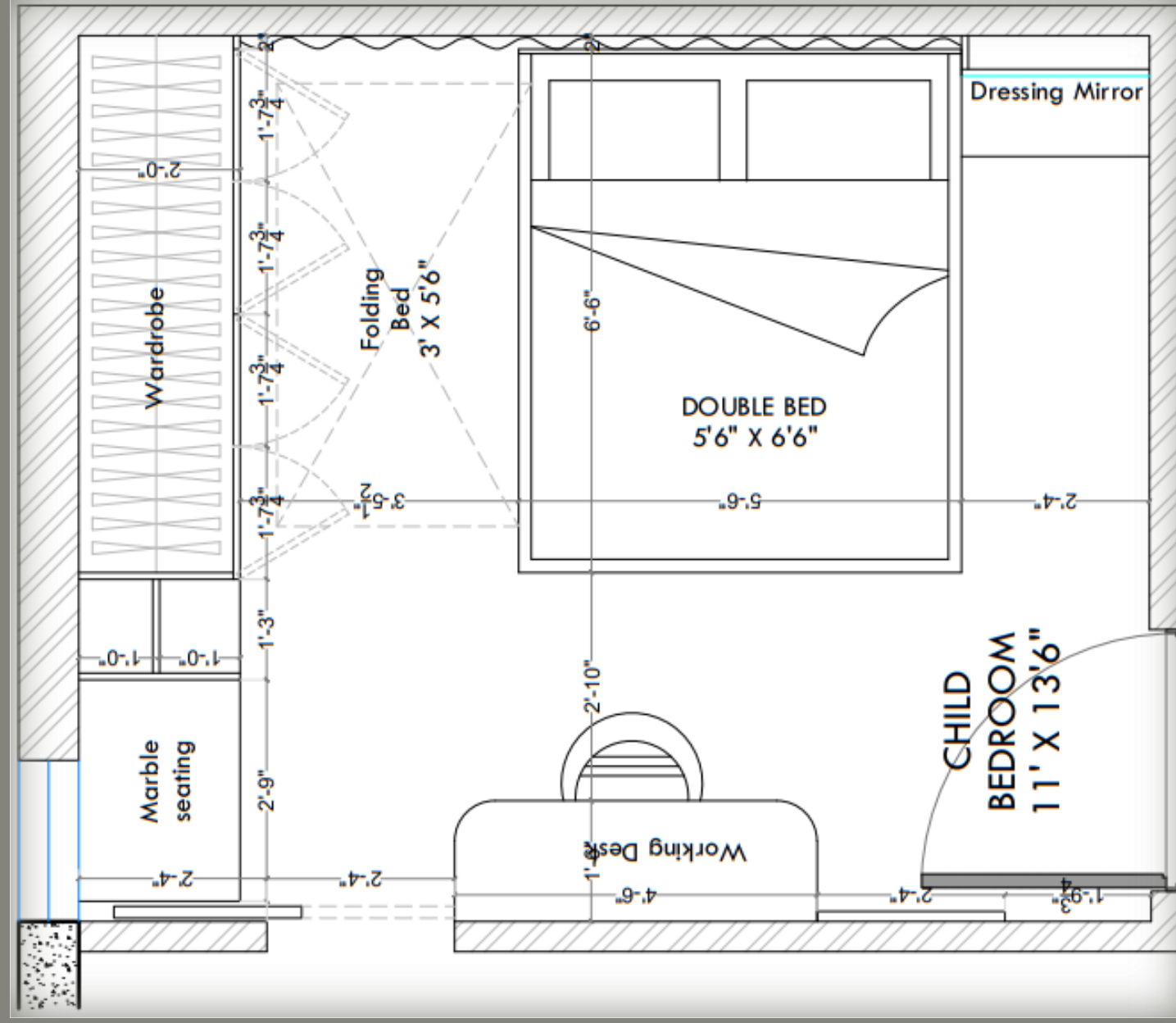

# CHILDREN BEDROOM

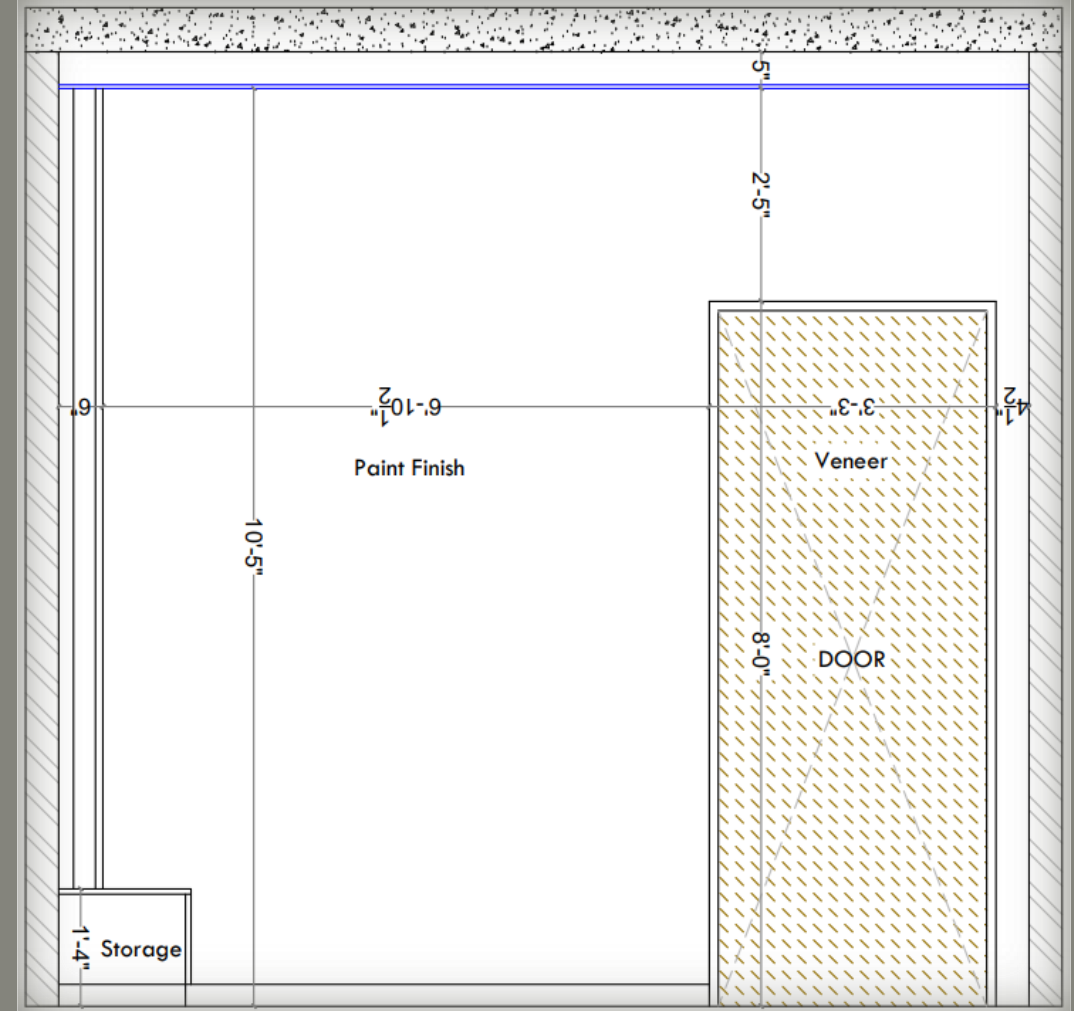
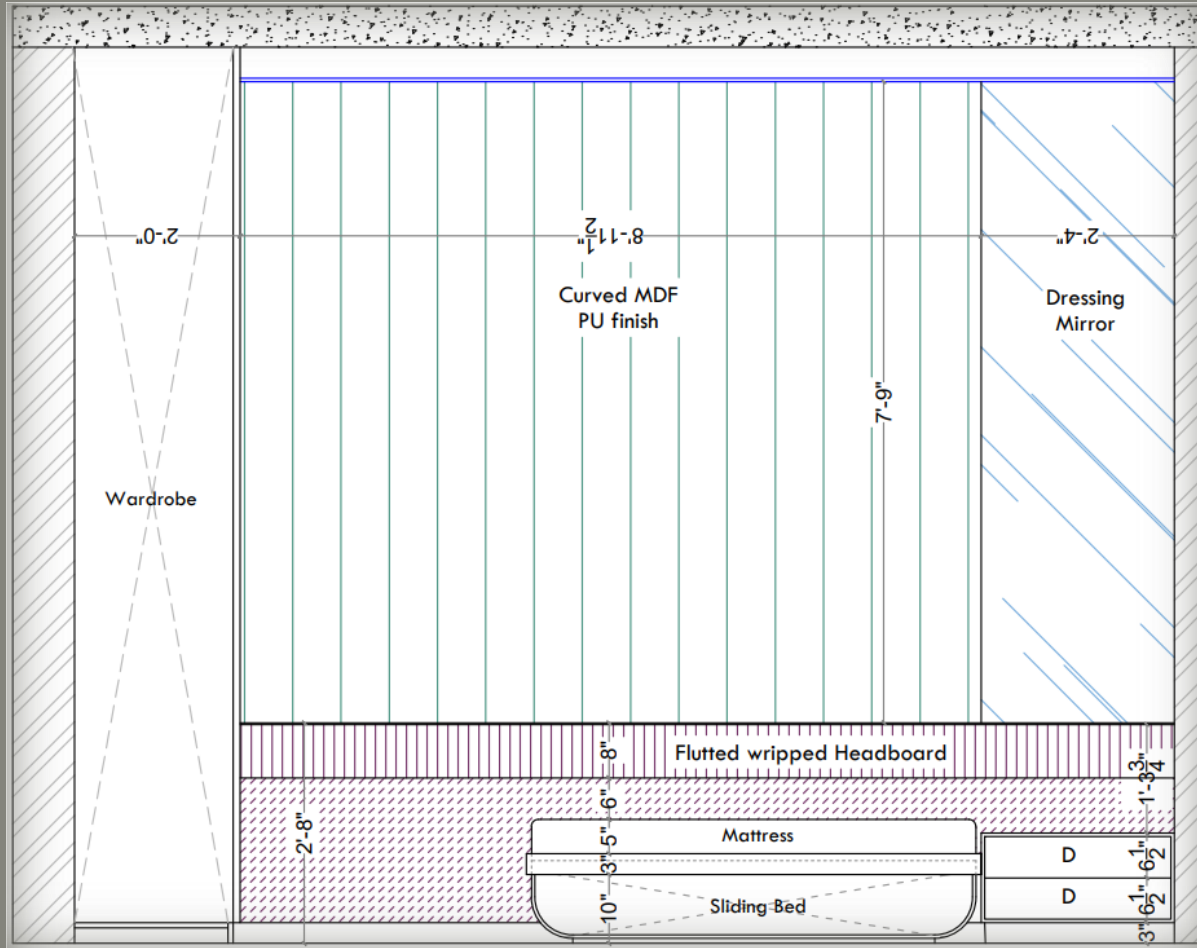

# CHILDREN BEDROOM



# CHILDREN BEDROOM

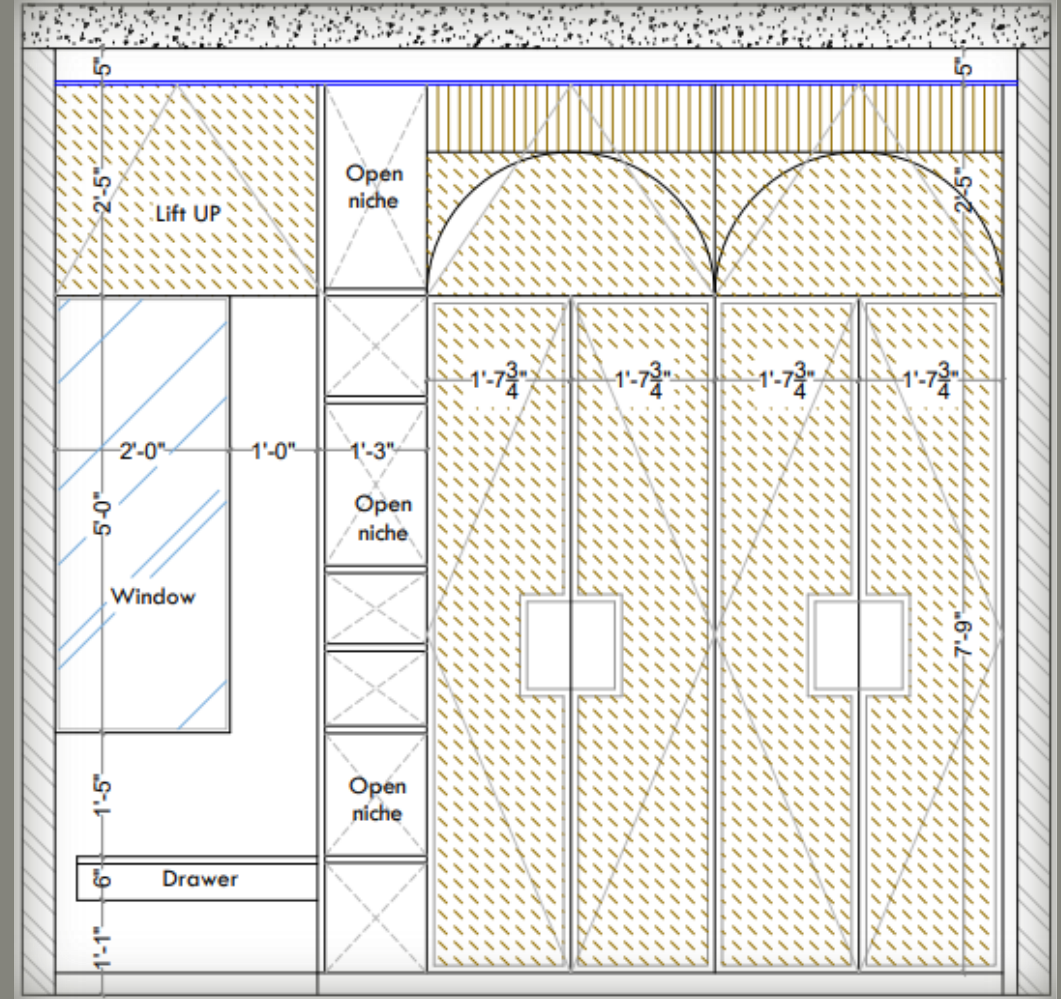
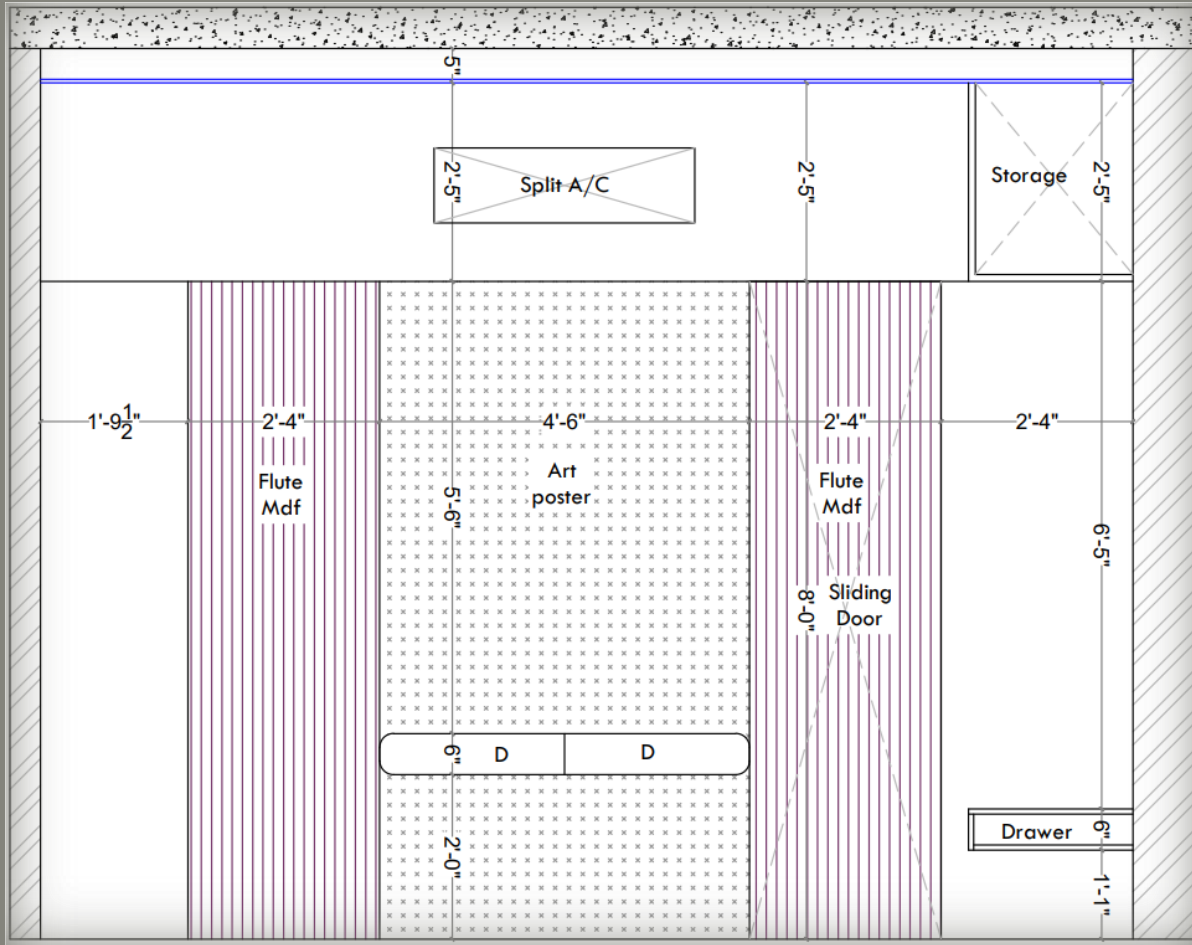

# CHILDREN BEDROOM



# CHILDREN BEDROOM



**CHILDREN BEDROOM  
OPTION-02**

# CHILDREN BEDROOM

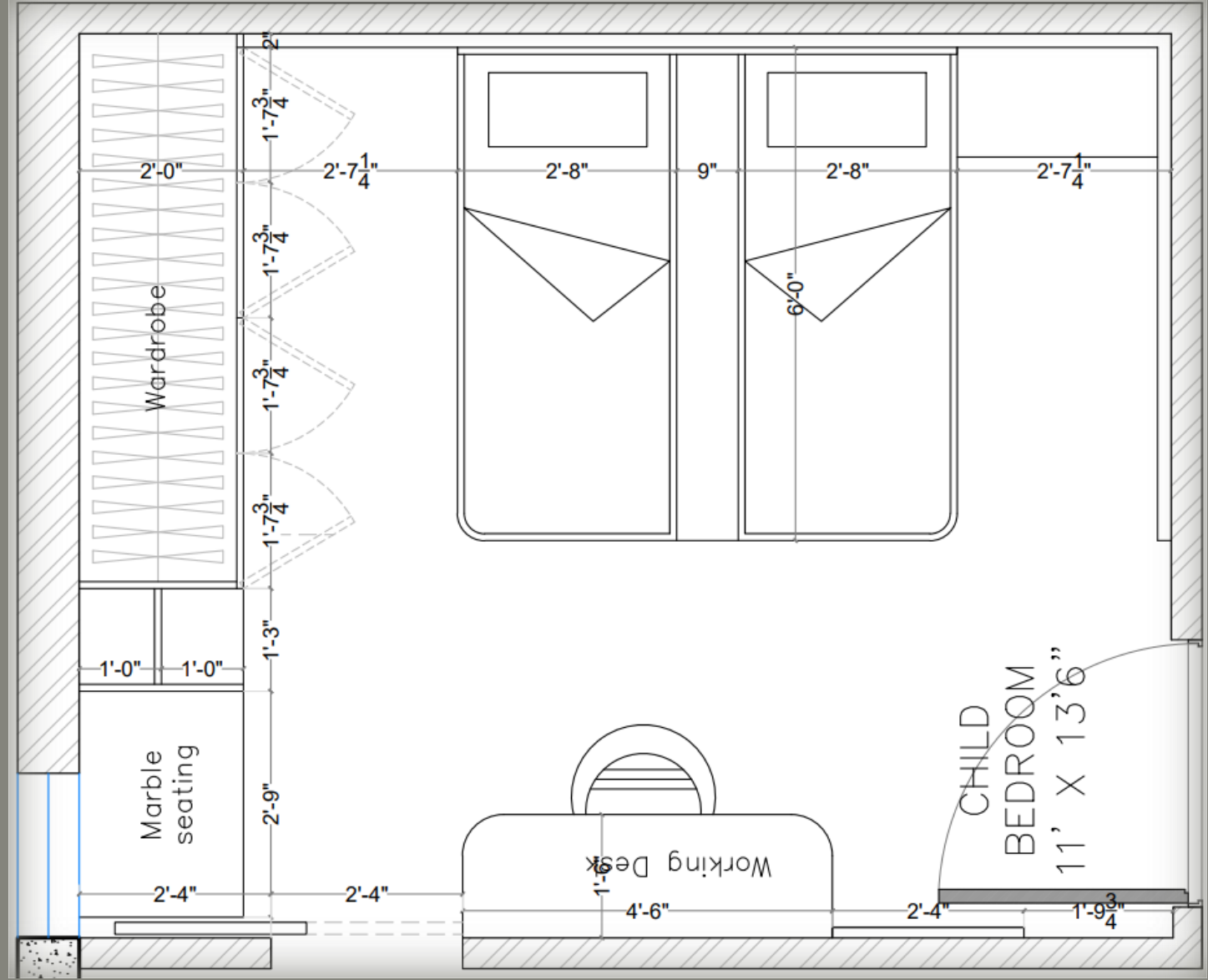

# CHILDREN BEDROOM

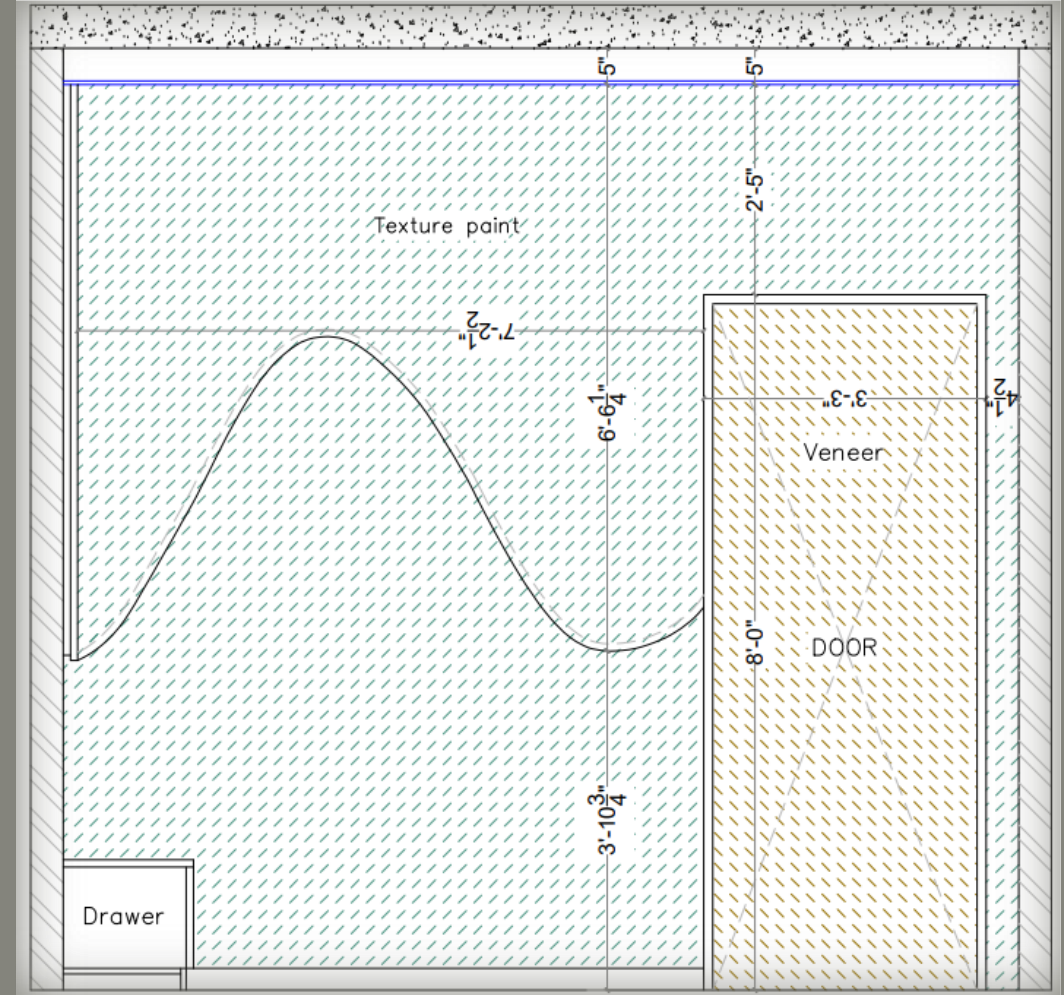
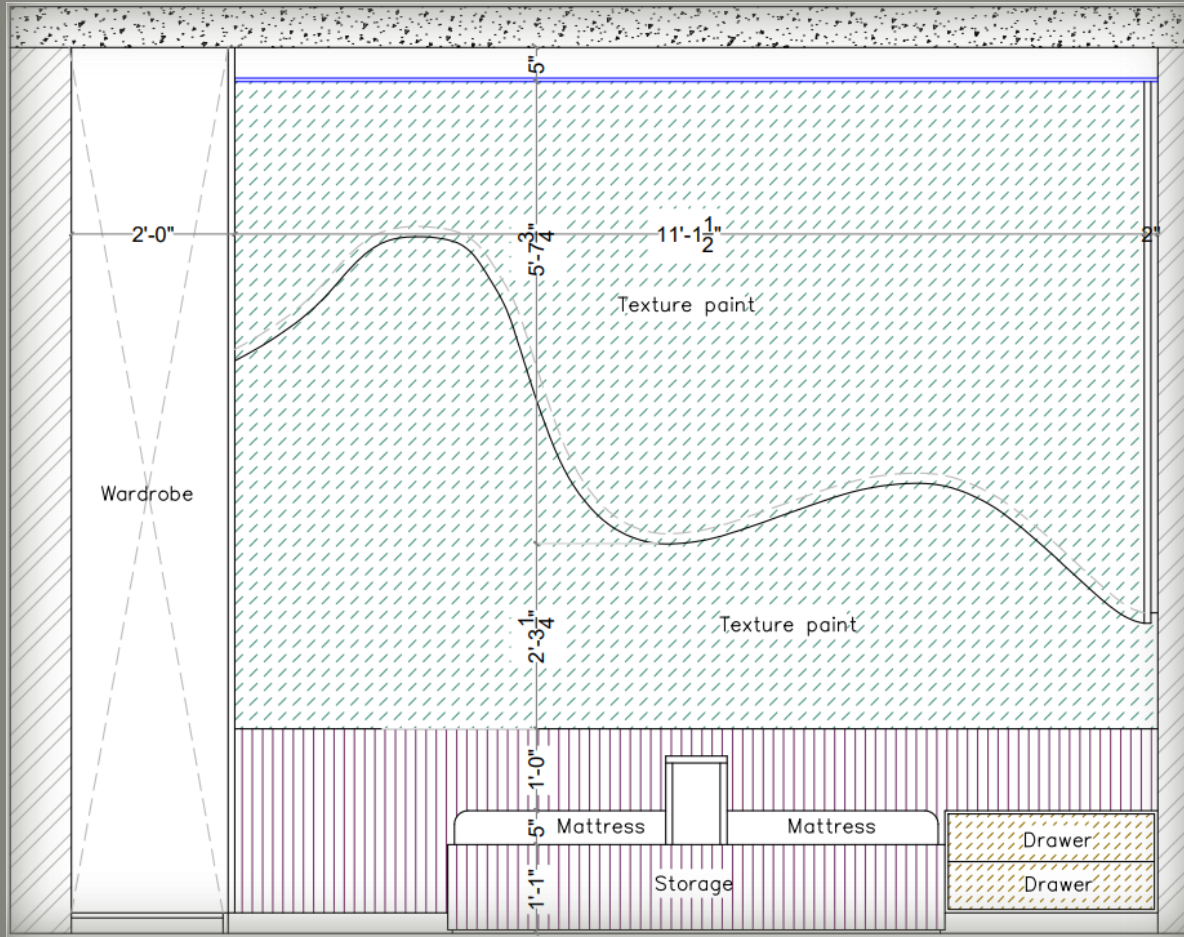

# CHILDREN BEDROOM



# CHILDREN BEDROOM



# CHILDREN BEDROOM

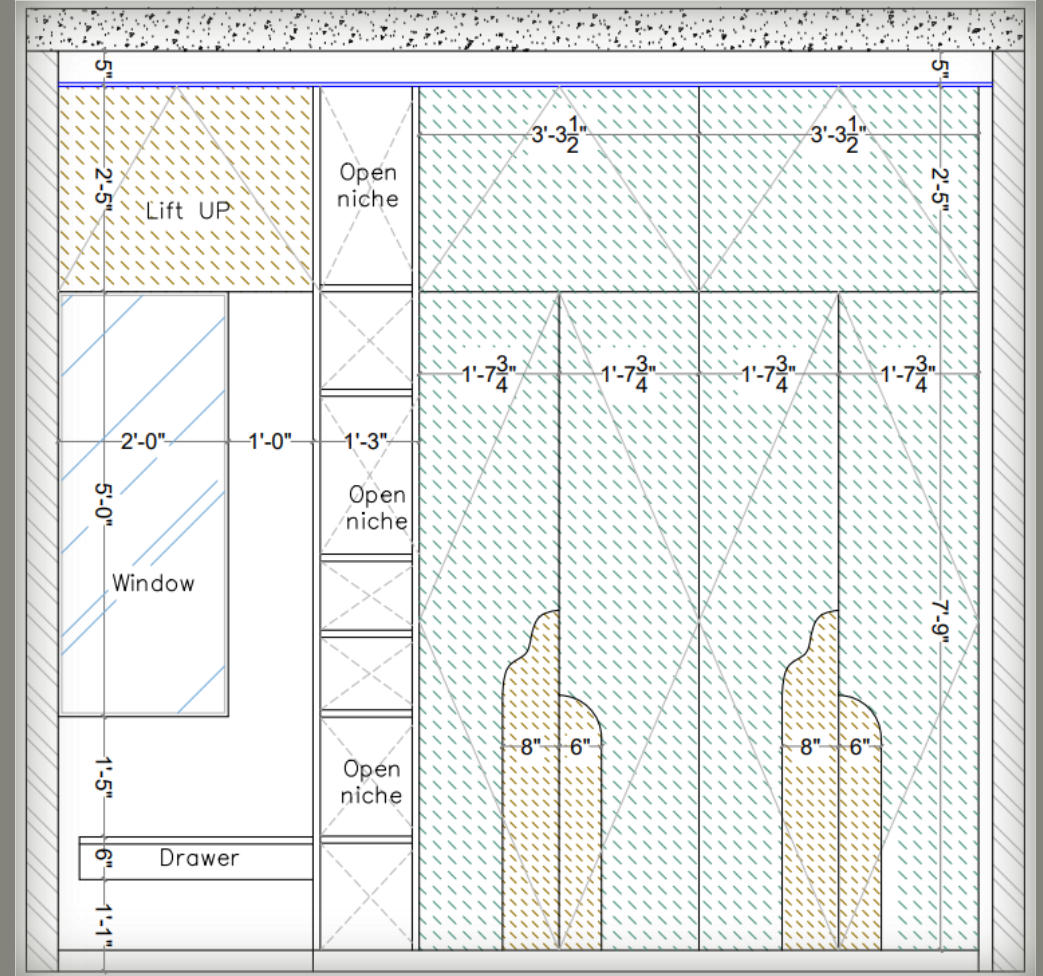
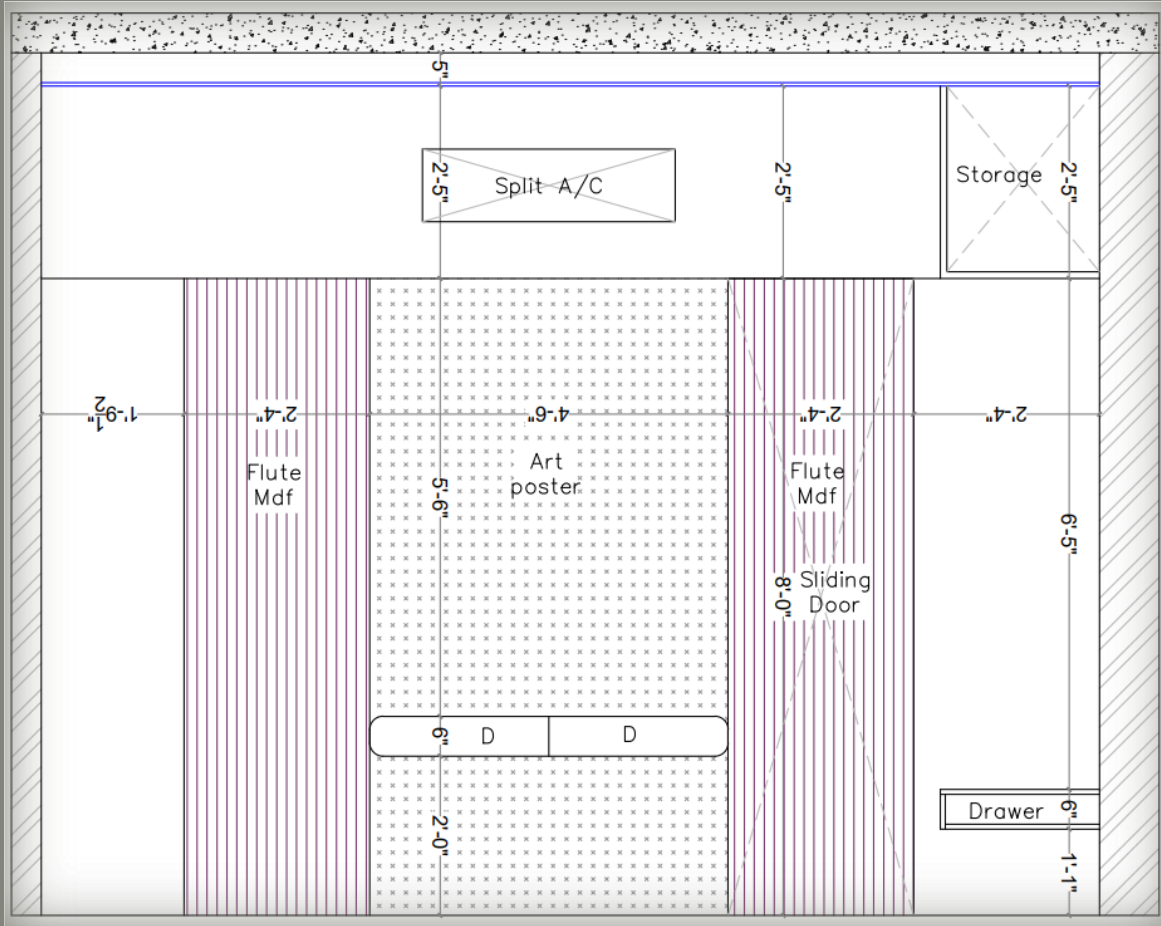

# CHILDREN BEDROOM



# CHILDREN BEDROOM



math  
 $c+1=00$   
 $xy+gbyy$   
 $c+1=00$



# CHILDREN BEDROOM

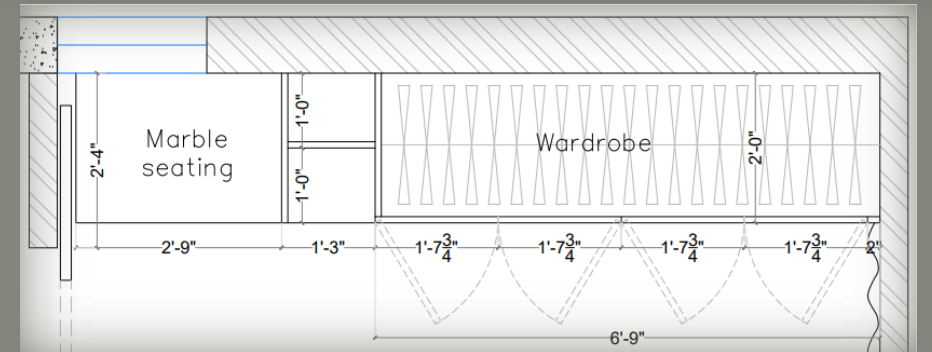
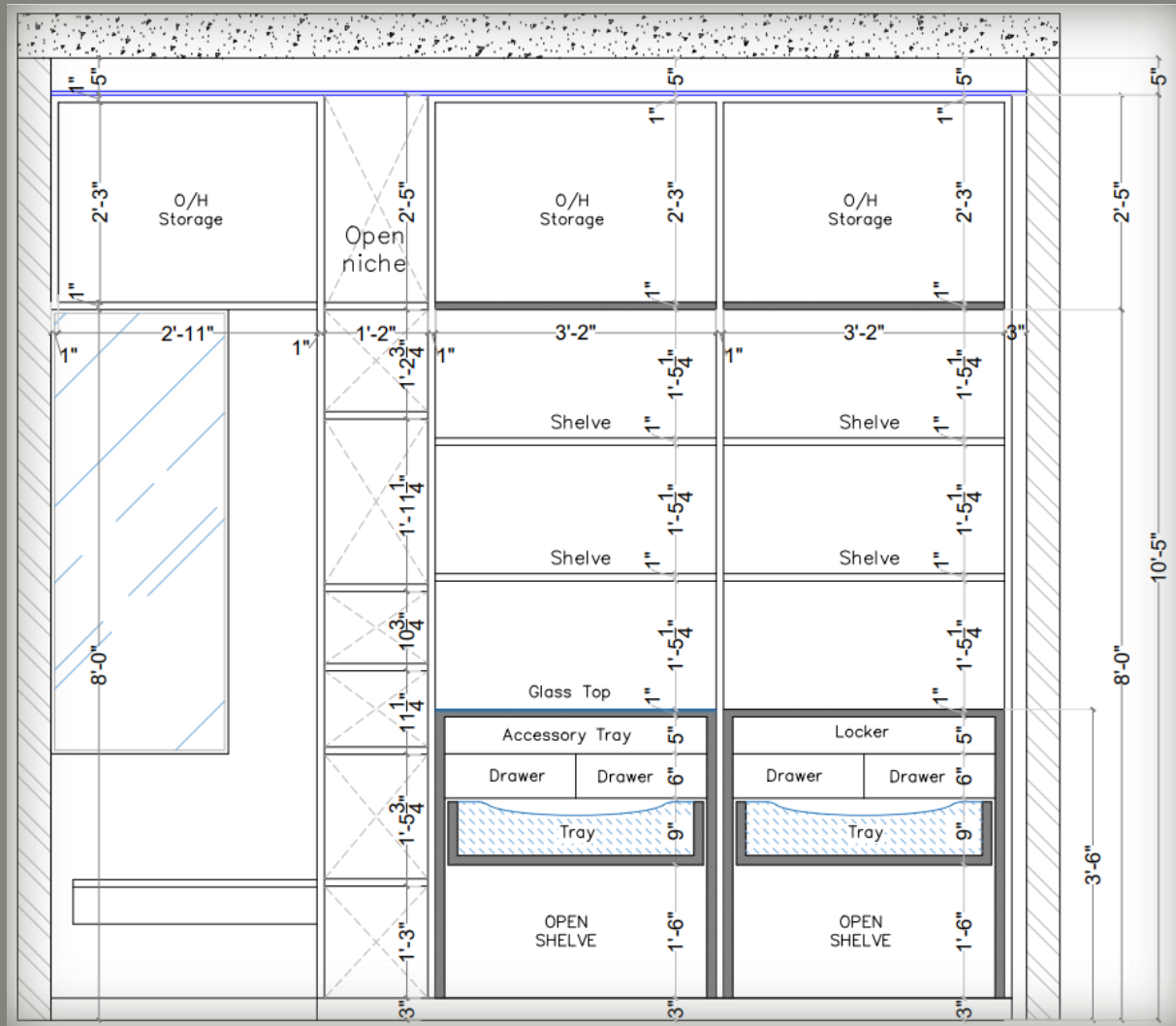

WARDROBE INTERNAL

# CHILDREN BEDROOM

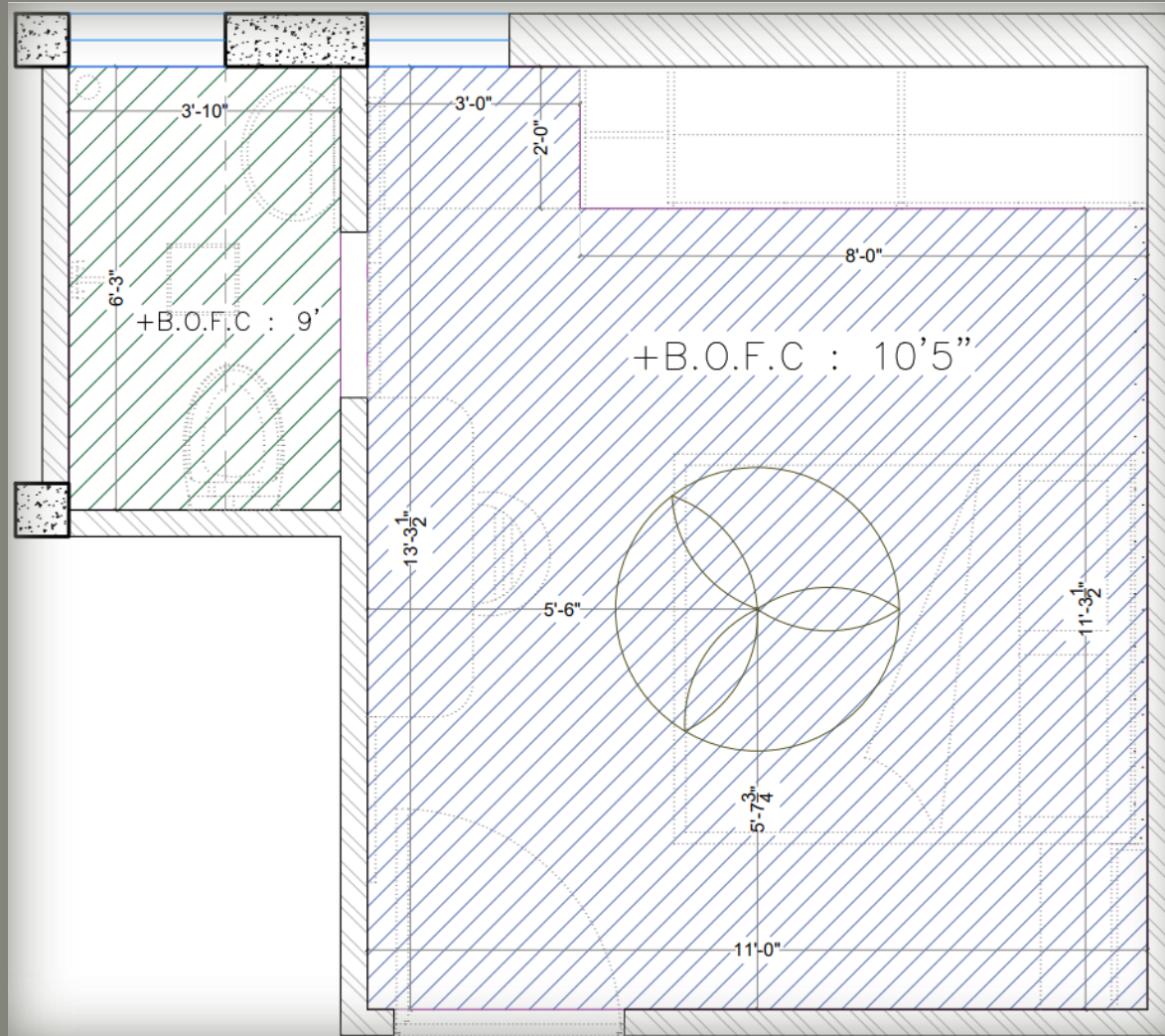

CEILING LAYOUT

# CHILDREN BEDROOM

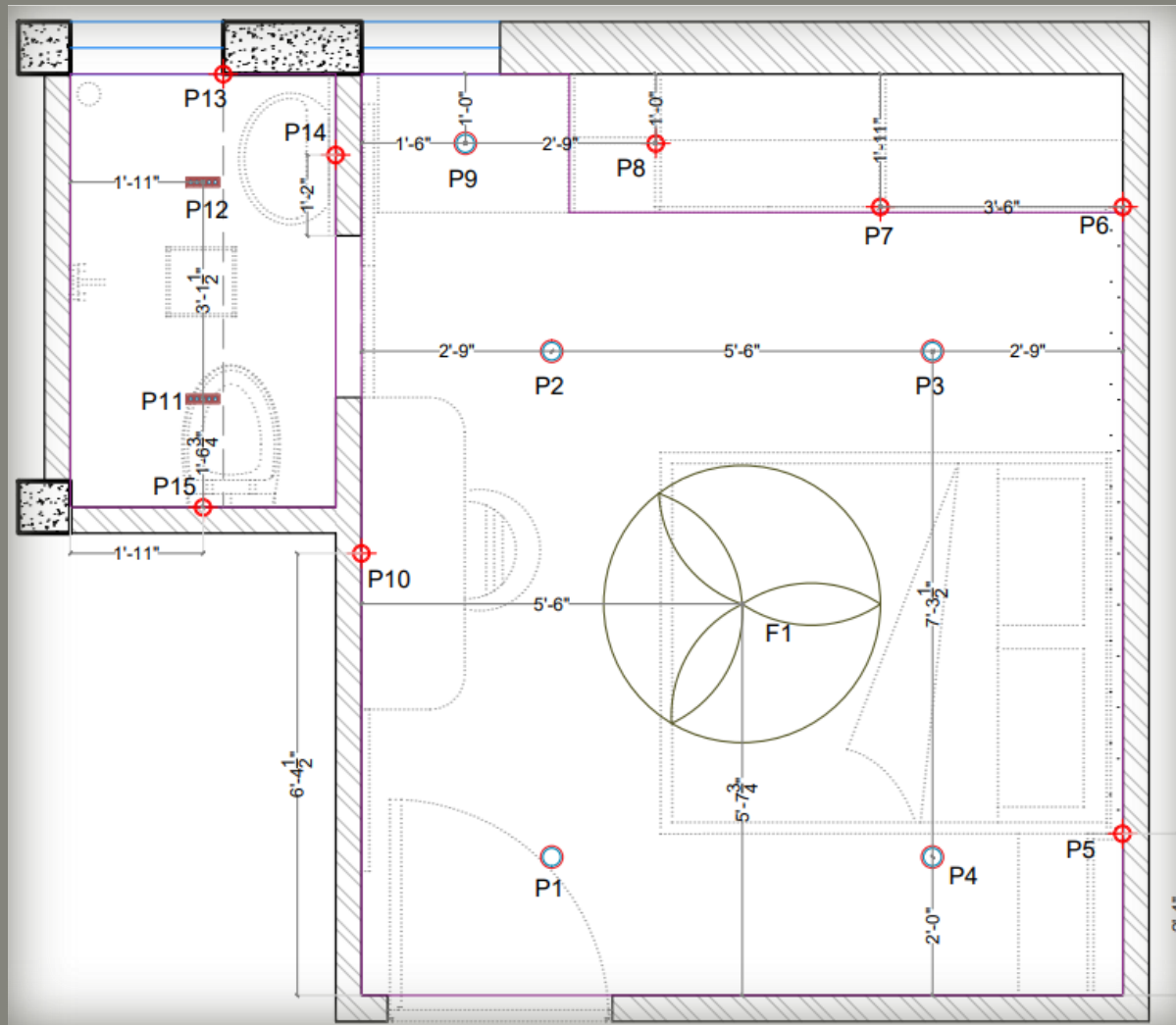

ELECTRICAL LAYOUT

# CHILDREN BEDROOM

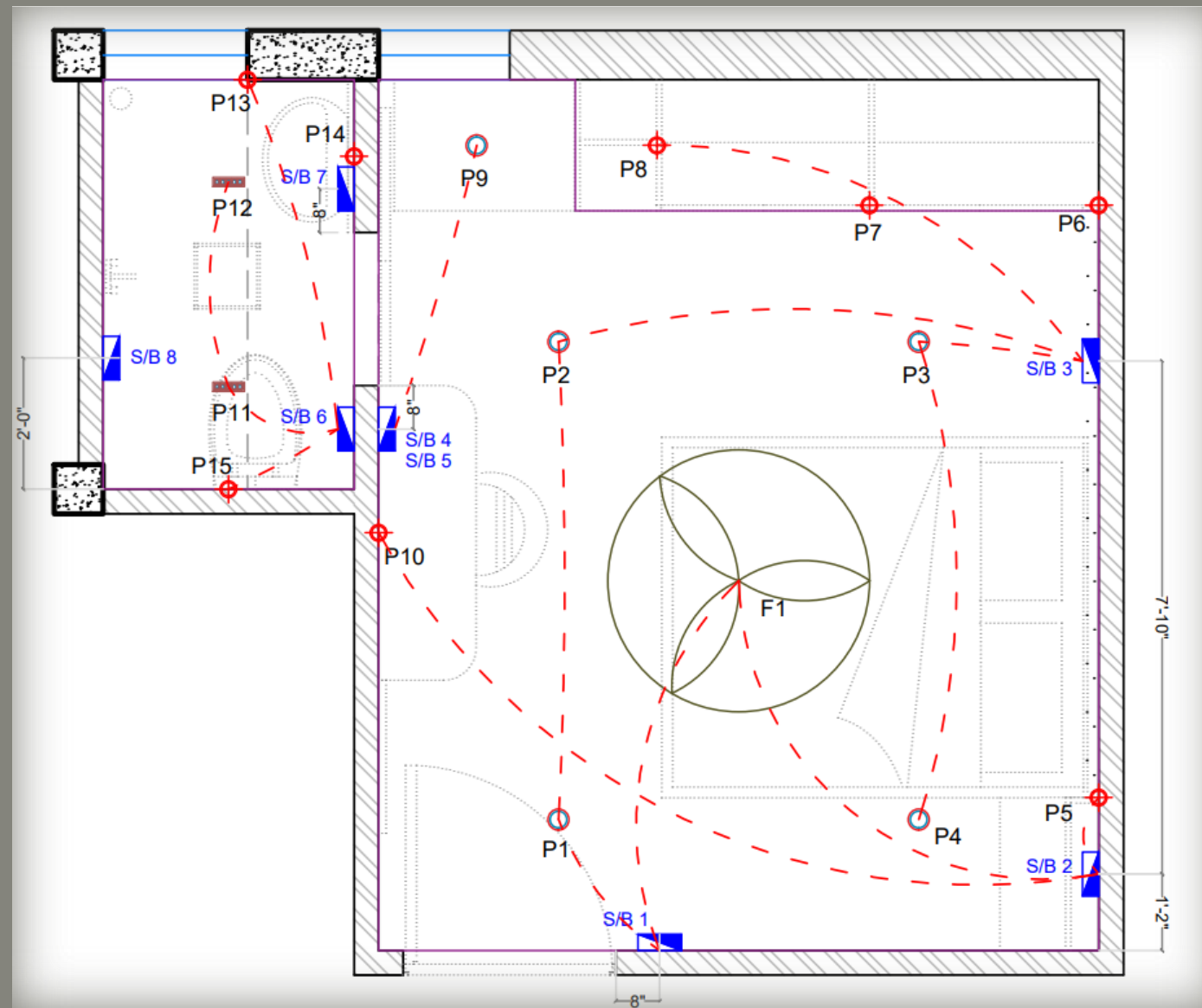

ELECTRICAL LOOPING LAYOUT

# CHILDREN BATHROOM

# CHILDREN BATHROOM

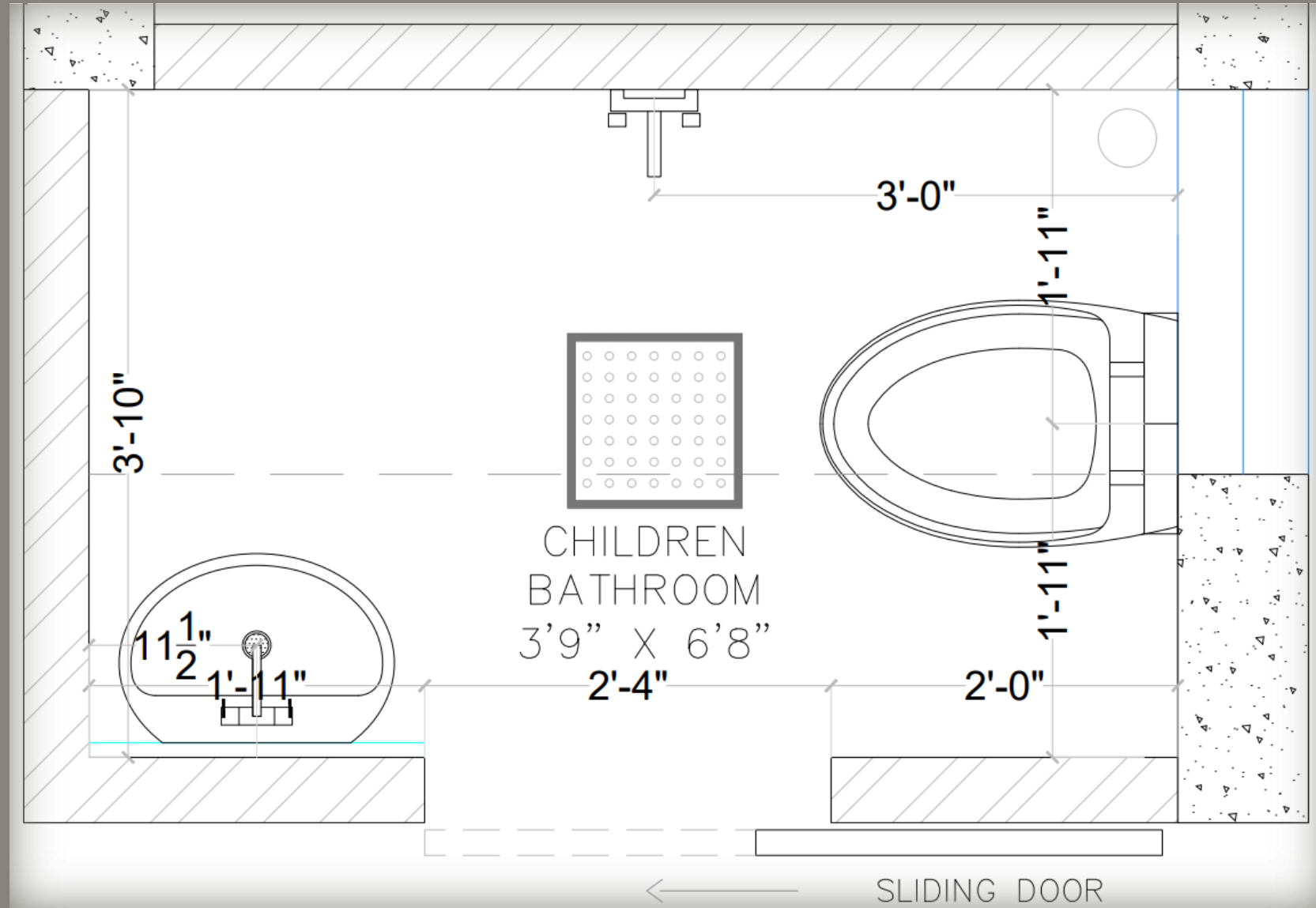

THANK YOU