

STEEL WIRE ROPE SLINGS AND FITTINGS

MEASURING AND ORDERING OF STEEL WIRE ROPE SLINGS

Working load limits

using 6x19 or 6x36 IWRC (1960mpa)

SANS7531

SWR Ø	nominal break load	1 Leg				2 Leg				3 and 4 Leg			endless choke **
		0°	choke	halshing	basket	angle between the legs				angle between the legs			
						60°	90°	120°	reeving	60°	90°	120°	
[mm]	[kN]	[t]	[t]	[t]	[t]	[t]	[t]	[t]	[t]	[t]	[t]	[t]	[t]
8	44.7	0.72	0.54	1.07	1.01	1.22	1.00	0.72	0.76	1.86	1.50	1.07	0.80
9	56.5	0.90	0.68	1.36	1.27	1.54	1.27	0.90	0.96	2.35	1.90	1.36	1.02
10	69.8	1.12	0.84	1.68	1.57	1.90	1.56	1.12	1.18	2.90	2.35	1.68	1.26
11	84.4	1.35	1.01	2.03	1.90	2.30	1.89	1.35	1.43	3.51	2.84	2.03	1.52
12	100.0	1.60	1.20	2.40	2.26	2.72	2.24	1.60	1.70	4.16	3.36	2.40	1.80
13	118.0	1.89	1.42	2.83	2.66	3.21	2.64	1.89	2.00	4.91	3.96	2.83	2.12
14	137.0	2.19	1.64	3.29	3.09	3.73	3.07	2.19	2.32	5.70	4.60	3.29	2.47
16	179.0	2.86	2.15	4.30	4.04	4.87	4.01	2.86	3.04	7.45	6.01	4.30	3.22
18	226.0	3.62	2.71	5.42	5.10	6.15	5.06	3.62	3.83	9.40	7.59	5.42	4.07
20	279.0	4.46	3.35	6.70	6.29	7.59	6.25	4.46	4.73	11.61	9.37	6.70	5.02
22	338.0	5.41	4.06	8.11	7.63	9.19	7.57	5.41	5.73	14.06	11.36	8.11	6.08
24	402.0	6.43	4.82	9.65	9.07	10.93	9.00	6.43	6.82	16.72	13.51	9.65	7.24
26	472.0	7.55	5.66	11.33	10.65	12.84	10.57	7.55	8.01	19.64	15.86	11.33	8.50
28	547.0	8.75	6.56	13.13	12.34	14.88	12.25	8.75	9.28	22.76	18.38	13.13	9.85
30	628.0	10.05	7.54	15.07	14.17	17.08	14.07	10.05	10.65	26.12	21.10	15.07	11.30
32	715.0	11.44	8.58	17.16	16.13	19.45	16.02	11.44	12.13	29.74	24.02	17.16	12.87
34	807.0	12.91	9.68	19.37	18.21	21.95	18.08	12.91	13.69	33.57	27.12	19.37	14.53

36	904.0	14.46	10.85	21.70	20.39	24.59	20.25	14.46	15.33	37.61	30.37	21.70	16.27
38	1008.0	16.13	12.10	24.19	22.74	27.42	22.58	16.13	17.10	41.93	33.87	24.19	18.14
40	1120.0	17.92	13.44	26.88	25.27	30.46	25.09	17.92	19.00	46.59	37.63	26.88	20.16
42	1231.0	19.70	14.77	29.54	27.77	33.48	27.57	19.70	20.88	51.21	41.36	29.54	22.16
44	1350.0	21.60	16.20	32.40	30.46	36.72	30.24	21.60	22.90	56.16	45.36	32.40	24.30
48	1610.0	25.76	19.32	38.64	36.32	43.79	36.06	25.76	27.31	66.98	54.10	38.64	28.98
52*	1890.0	30.24	22.68	45.36	42.64	51.41	42.34	30.24	32.05	78.62	63.50	45.36	34.02
54*	2035.0	32.56	24.42	48.84	45.91	55.35	45.58	32.56	34.51	84.66	68.38	48.84	36.63
56*	2422.0	38.76	29.07	58.13	54.64	65.88	54.26	38.76	41.08	100.76	81.39	58.13	42.01
60*	2769.4	44.41	33.23	66.47	62.48	75.33	62.03	44.41	46.97	115.21	93.05	66.47	49.90
64*	2951.8	47.23	35.42	70.84	66.59	80.29	66.12	47.23	50.06	122.79	99.18	70.84	52.57
76*	4167.8	66.68	50.01	100.03	94.03	113.36	93.36	66.68	70.69	173.38	140.04	100.03	74.70

load
factor

		1.00	0.75	1.50	1.41	1.70	1.40	1.00	1.06	2.60	2.10	1.50	1.60
--	--	------	------	------	------	------	------	------	------	------	------	------	------

the working load limits above apply to normal conditions of use, in straight configuration and based on the "uniform load" method of rating

- working load limits for sizes 52mm to 76mm calculated using 6x36 IWRC 2160mpa (EEIPS) nominal break loads
- ** factor of safety for endless choke sling is 8:1 according to the OHSA

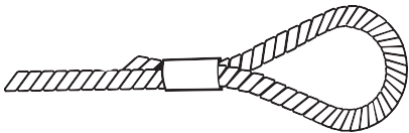

soft eye aluminium ferrule

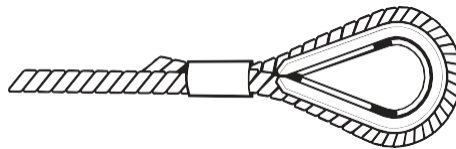

hard eye aluminium ferrule

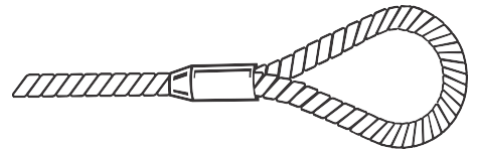

Flemish soft eye aluminium ferrule



Working load limits

using 6x19 or 6x36 IWRC (1960mpa)

EN13414-1

SWR Ø	nominal break load	1 Leg				2 Leg				3 and 4 Leg			endles s choke f.o.s 8:1
		0°	choke	halshin g	basket	angle between the legs				angle between the legs			
						60°	90°	120°	reeving	60°	90°	120°	
[mm]	[kN]	[t]	[t]	[t]	[t]	[t]	[t]	[t]	[t]	[t]	[t]	[t]	[t]
8	44.7	0.82	0.62	1.23	1.16	1.39	1.15	0.82	0.87	2.13	1.72	1.23	1.31
9	56.5	1.04	0.78	1.56	1.46	1.76	1.45	1.04	1.10	2.70	2.18	1.56	1.66
10	69.8	1.28	0.96	1.92	1.81	2.18	1.79	1.28	1.36	3.33	2.69	1.92	2.05
11	84.4	1.55	1.16	2.32	2.18	2.63	2.17	1.55	1.64	4.03	3.25	2.32	2.48
12	100.0	1.84	1.38	2.75	2.59	3.12	2.57	1.84	1.95	4.77	3.85	2.75	2.94
13	118.0	2.17	1.62	3.25	3.05	3.68	3.03	2.17	2.30	5.63	4.55	3.25	3.47
14	137.0	2.51	1.89	3.77	3.55	4.27	3.52	2.51	2.67	6.54	5.28	3.77	4.02
16	179.0	3.29	2.46	4.93	4.63	5.59	4.60	3.29	3.48	8.54	6.90	4.93	5.26
18	226.0	4.15	3.11	6.22	5.85	7.05	5.81	4.15	4.40	10.79	8.71	6.22	6.64
20	279.0	5.12	3.84	7.68	7.22	8.71	7.17	5.12	5.43	13.31	10.75	7.68	8.19
22	338.0	6.20	4.65	9.31	8.75	10.55	8.69	6.20	6.58	16.13	13.03	9.31	9.93
24	402.0	7.38	5.53	11.07	10.40	12.54	10.33	7.38	7.82	19.18	15.50	11.07	11.81
26	472.0	8.66	6.50	13.00	12.22	14.73	12.13	8.66	9.18	22.53	18.19	13.00	13.86
28	547.0	10.04	7.53	15.06	14.16	17.07	14.06	10.04	10.64	26.10	21.08	15.06	16.06
30	628.0	11.53	8.65	17.29	16.25	19.60	16.14	11.53	12.22	29.97	24.21	17.29	18.44
32	715.0	13.12	9.84	19.69	18.50	22.31	18.37	13.12	13.91	34.12	27.56	19.69	21.00
34	807.0	14.81	11.11	22.22	20.89	25.18	20.74	14.81	15.70	38.51	31.11	22.22	23.70
36	904.0	16.59	12.44	24.89	23.40	28.21	23.23	16.59	17.59	43.14	34.84	24.89	26.55
38	1008.0	18.50	13.88	27.75	26.09	31.45	25.90	18.50	19.61	48.10	38.85	27.75	29.60
40	1120.0	20.56	15.42	30.84	28.99	34.95	28.78	20.56	21.79	53.45	43.17	30.84	32.89
42	1231.0	22.59	16.95	33.89	31.86	38.41	31.63	22.59	23.95	58.75	47.45	33.89	36.15
44	1350.0	24.78	18.58	37.17	34.94	42.12	34.69	24.78	26.27	64.43	52.04	37.17	39.65
48	1610.0	29.55	22.16	44.33	41.67	50.24	41.37	29.55	31.32	76.83	62.06	44.33	47.28
52*	1890.0	34.69	26.02	52.04	48.91	58.97	48.57	34.69	36.77	90.20	72.85	52.04	55.51
54*	2035.0	37.35	28.01	56.03	52.67	63.50	52.29	37.35	39.59	97.12	78.44	56.03	59.76
56*	2422.0	44.46	33.34	66.68	62.68	75.57	62.24	44.46	47.12	115.58	93.36	66.68	71.13
60*	2769.4	50.83	38.12	76.25	71.67	86.41	71.16	50.83	53.88	132.16	106.75	76.25	81.33

64*	2951.8	54.18	40.63	81.27	76.39	92.11	75.85	54.18	57.43	140.87	113.78	81.27	86.69
76*	4167.8	76.50	57.37	114.75	107.86	130.05	107.1	76.50	81.09	198.9	160.65	114.75	122.40

load factor

		1.00	0.75	1.50	1.41	1.70	1.40	1.00	1.06	2.60	2.10	1.50	1.60
--	--	------	------	------	------	------	------	------	------	------	------	------	------

the working load limits above apply to normal conditions of use, in straight configuration and based on the "uniform load" method of rating

- working load limits for sizes 52mm to 76mm calculated using 6x36 IWRC 2160mpa (EEIPS) nominal break loads

Apply the following factors when not using the full

number of legs:

type of sling	no. of legs	load factor
2	1	WLL x 0.50
3 or 4	2	WLL x 0.75
3 or 4	1	WLL x 0.33



FERRULES

EN13411-

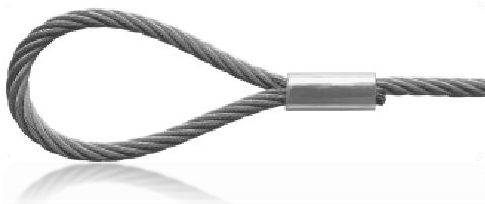

Code	Aluminium				
	A	B	W	L	Weight
	[mm]	[mm]	[mm]	[mm]	[kg/1000pcs]
1.0	1.2	2.4	0.65	5	0.094
1.5	1.7	3.4	0.75	6	0.211
2.0	2.2	4.4	0.85	7	0.375
2.5	2.7	5.4	1.05	9	0.499
3.0	3.3	6.6	1.25	11	0.843
4.0	4.4	8.8	1.70	14	1.81
4.5	4.9	9.8	1.90	16	2.61
5.0	5.5	11.0	2.10	18	3.57
6.0	6.6	13.2	2.50	21	7.55
7.0	7.8	15.6	2.90	25	9.53
8.0	8.8	17.6	3.30	28	13.70
9.0	9.9	19.8	3.70	32	19.80
10.0	10.0	21.8	4.10	35	26.40
11.0	12.1	24.2	4.50	39	35.80
12.0	13.2	26.4	4.90	42	45.80
13.0	14.2	28.4	5.40	46	59.70
14.0	15.3	30.6	5.80	49	73.50
16.0	17.5	35.0	6.70	56	111.00
18.0	19.6	39.2	7.60	63	156.00
20.0	21.7	43.4	8.40	70	217.00
22.0	24.3	48.6	9.20	77	292.00
24.0	26.4	52.8	10.00	84	376.00
26.0	28.5	57.0	10.90	91	481.00
28.0	31.0	62.0	11.70	98	603.00
30.0	33.1	66.2	12.50	105	739.00
32.0	35.2	70.4	13.40	112	897.00
34.0	37.8	75.6	14.20	119	1077.00

36.0	39.8	79.6	15.00	126	1275.00
38.0	41.9	83.8	15.80	133	1503.00
40.0	44.0	88.0	16.60	140	1734.00
42.0	46.2	92.4	17.50	147	2024.00
44.0	48.4	96.8	18.30	154	2314.00
46.0	50.6	101.2	19.20	161	2662.00
48.0	52.8	105.6	20.00	168	3010.00
50.0	55.0	110.0	20.80	175	3412.00
52.0	57.2	114.4	21.60	182	3813.00
54.0	59.4	118.8	22.50	189	4293.00
56.0	61.6	123.2	23.30	196	4772.00
58.0	63.8	127.6	24.20	203	5326.00
60.0	66.0	132.0	25.00	210	5880.00

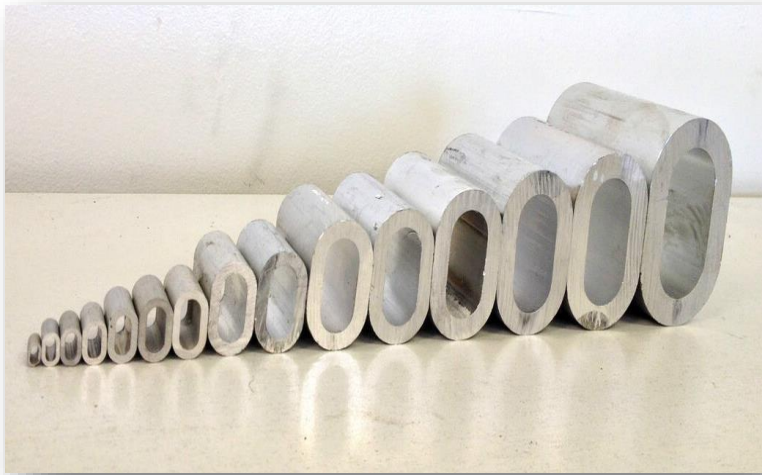

General purpose thimbles

mild steel, electro-galvanised

SWR Ø	Groove width	Length	Width	Inside length	Inside width	Weight
	A	B	C	D	E	
[mm]	[mm]	[mm]	[mm]	[mm]	[mm]	[kg/100pcs]
3	3	24	18	15	10	0.4
4	4	25	19	16	11	0.4
5	5	31	22	22	16	0.8
6	6	37	29	26	19	1.4
7	7	44	32	32	22	2.0
8	8	51	38	34	24	2.8
9	9	57	42	38	29	3.0
10	10	64	44	42	32	4.8
11	11	70	51	48	35	7.5
12	12	76	57	51	38	8.0
14	14	82	60	57	40	10.0
16	16	89	64	60	42	15.0
18	18	102	69	67	45	22.0
20	20	115	79	76	51	25.0
22	22	127	89	83	54	32.0
24	24	140	102	88	64	46.0
26	26	152	105	102	68	66.0

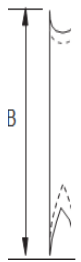
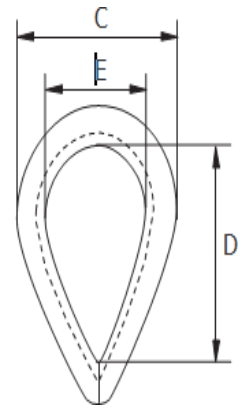

Stainless steel thimbles

SWR Ø	Groove width	Length	Inside width	Inside length	Thickness	Weight
	A	B	C	D	E	
[mm]	[mm]	[mm]	[mm]	[mm]	[mm]	[kg/100pcs]
3	3	25	10	16	1.0	0.4
6	6	39	16	25	1.2	1.0
10	10	55	26	40	1.9	2.9
20	20	115	45	78	3.0	21.3

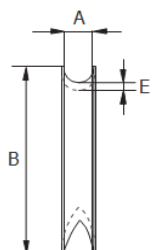
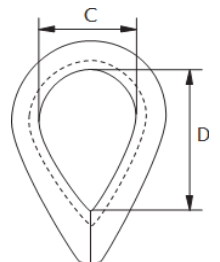

Heavy duty thimbles

mild steel, hot dipped galvanized

SWR Ø	Groove width	Length	Inside width	Inside length	Thickness	Weight
	A	B	C	D	E	
[mm]	[mm]	[mm]	[mm]	[mm]	[mm]	[kg/100pcs]
7	6	48	20	30	3.5	5.4
8	8	54	22	33	4.0	5.7
10	10	64	25	38	4.8	7.6
13	14	80	32	44	5.6	18.0
13	14	80	32	44	5.6	18.0
16	17	98	41	59	7.9	34.0
20	20	124	51	73	9.5	62.4
22	23	133	57	83	9.5	75.6

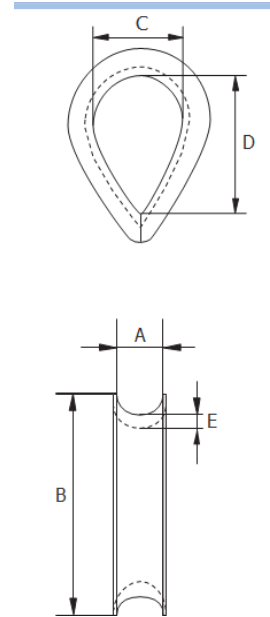

Carbon steel hook

Large eye hook

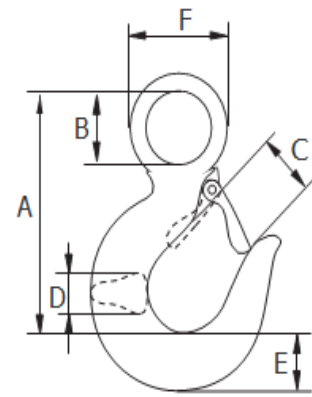

Working load limit	A	B	C	D	E	F	Weight
[t]	[mm]	[mm]	[mm]	[mm]	[mm]	[mm]	[kgs]
1.00	93	25	27	18	22	45	0.40
1.50	104	28	28	19	26	52	0.55
2.00	119	32	32	22	29	61	0.83
3.00	146	40	38	29	37	75	1.90
5.00	187	51	48	35	46	97	3.30
7.50	230	62	58	42	58	119	5.70
11.00	255	72	65	50	66	136	8.40

factor of safety 5:1

Carbon steel hook

Swivel hook

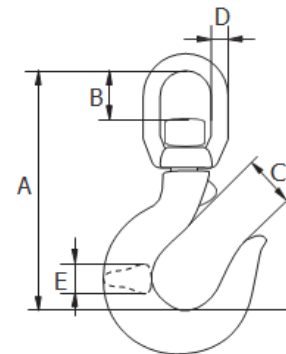
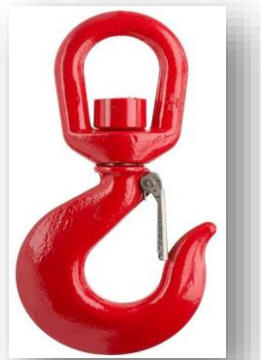

Working load limit	A	B	C	D	E	Weight
[t]	[mm]	[mm]	[mm]	[mm]	[mm]	[kgs]
0.75	155	29	29	12	28.0	0.93
1.00	170	30	30	16	30.7	1.27
1.50	185	35	34	18	36.5	1.92
2.00	215	40	35	20	40.0	2.67
3.00	245	50	42	24	48.0	4.22
5.00	300	60	52	30	56.0	7.75
7.5	360	65	65	33	71.0	13.65

Wire rope clamps – Commercial

Wire rope diameter	A	B	C	D	E	F	G	Weight 100pcs
[mm]	[mm]	[mm]	[mm]	[mm]	[mm]	[mm]	[mm]	[kgs]
3	4	20	9	12	21	10	10	1.4
5	5	24	11	13	23	11	10	1.5
6	5	28	13	15	26	12	11	2.1
8	6	34	16	19	30	14	15	4.1
10	8	42	19	22	34	18	17	6.8
11	8	44	20	22	36	19	18	7.2
13	10	55	24	30	42	23	21	13.0
14	10	57	25	30	44	23	22	13.5
16	12	63	29	33	50	26	26	21.0
19	12	75	32	38	54	29	30	28.0
22	14	85	37	44	61	33	34	40.0
26	14	95	41	45	65	35	37	44.0
30	16	110	48	50	74	37	43	66.0

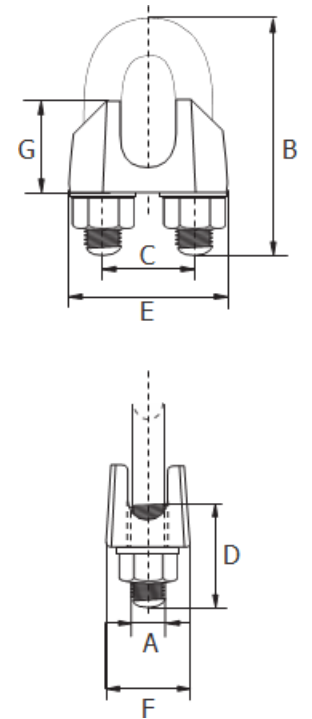

Wire rope clamps – Bulldog

Wire rope diameter	A	B	C	D	E	F	G	Weight 100pcs
[mm]	[mm]	[mm]	[mm]	[mm]	[mm]	[mm]	[mm]	[kgs]
5	5	25	12	14	25	13	13	2.0
6	6	32	14	17	30	16	14	4.0
8	8	41	18	20	39	20	18	8.2
10	8	46	20	24	40	20	21	9.2
12	10	56	24	28	50	25	24	21.5
13	12	64	29	29	55	28	29	27.5
16	14	76	34	35	64	32	35	43.0
22	16	96	41	40	74	34	44	68.0
28	20	111	46	50	84	38	51	117.0
32	20	127	54	55	95	41	59	140.0

