

GROOVE
DESIGNS

INTERIOR PRESENTATION

LALITH JAIN,
VIJAYAWADA

FLOOR PLAN

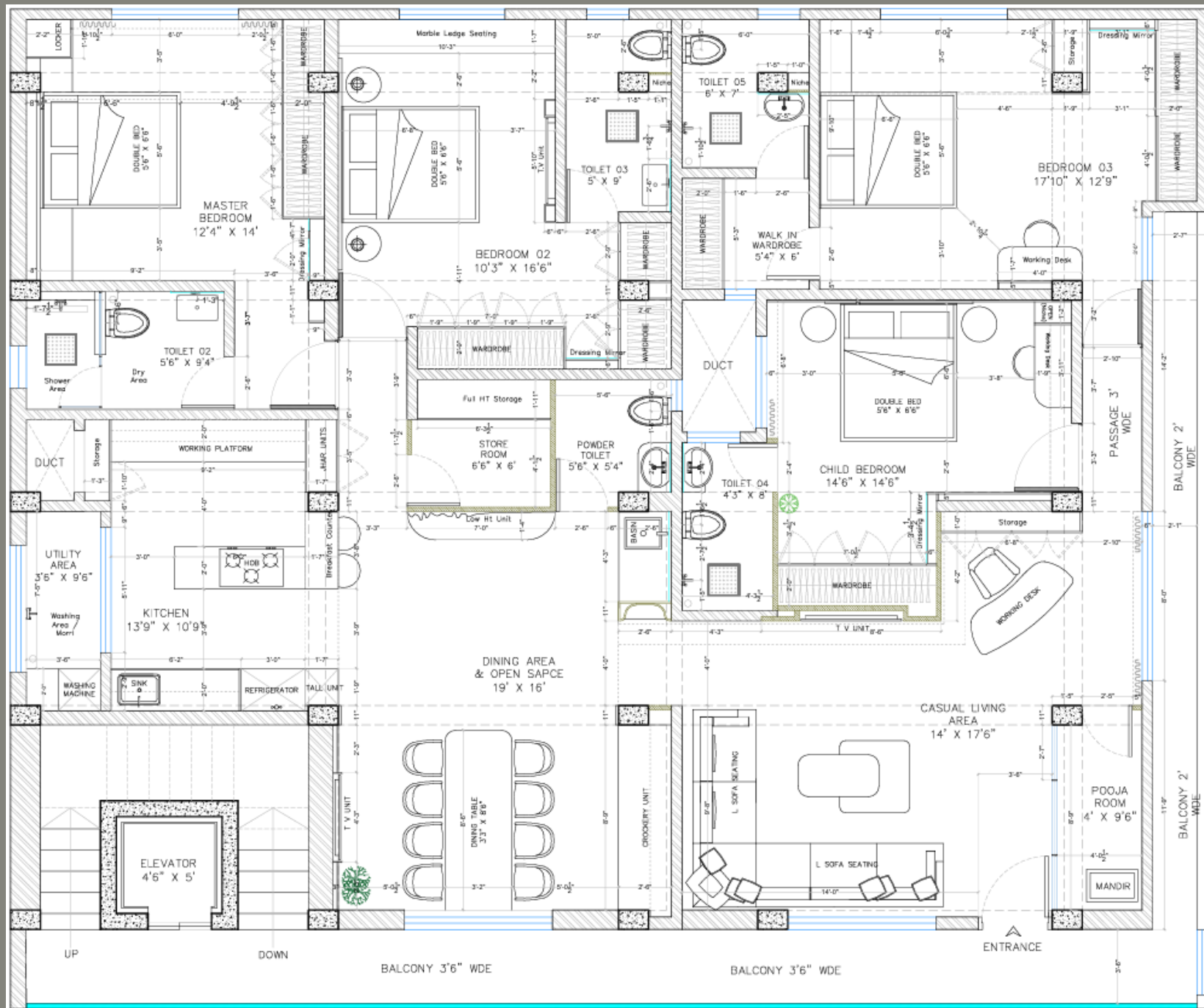

CASUAL LIVING AREA

FLOOR PLAN

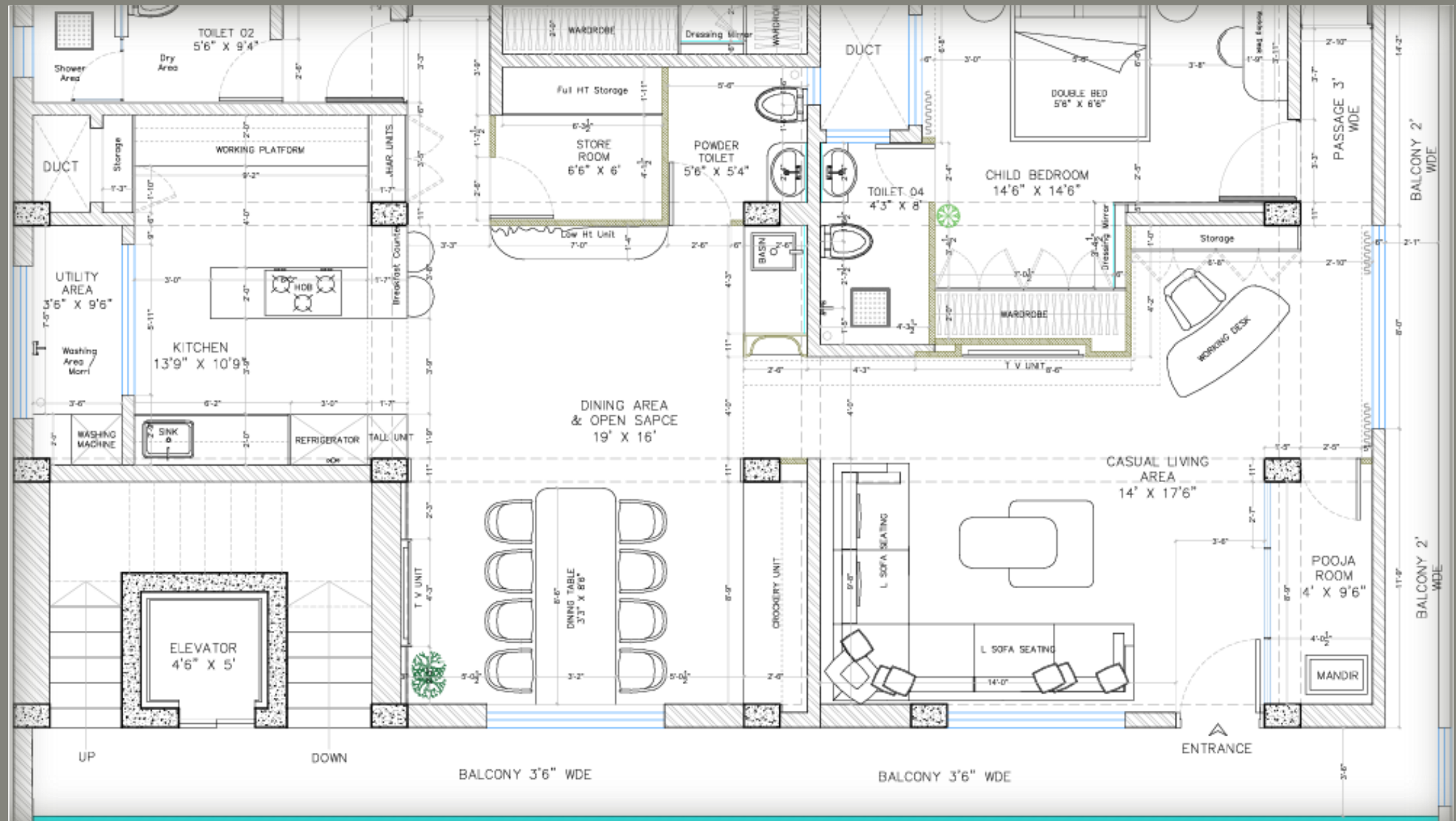

FORMAL LIVING AREA

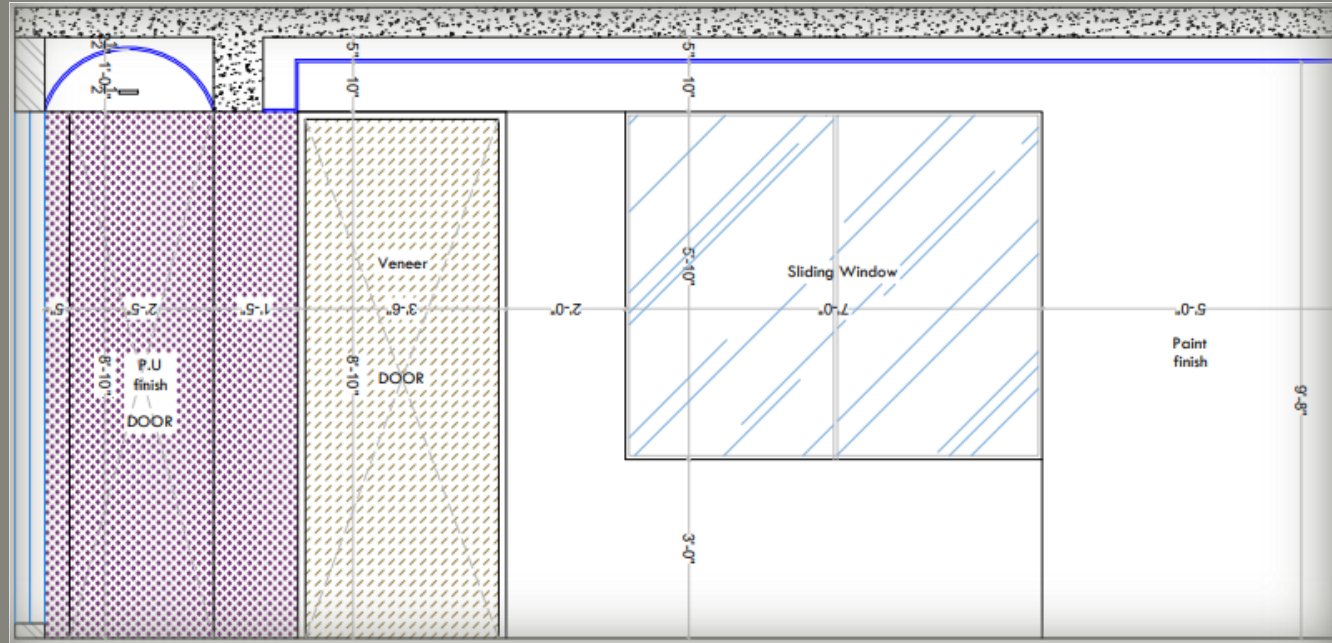
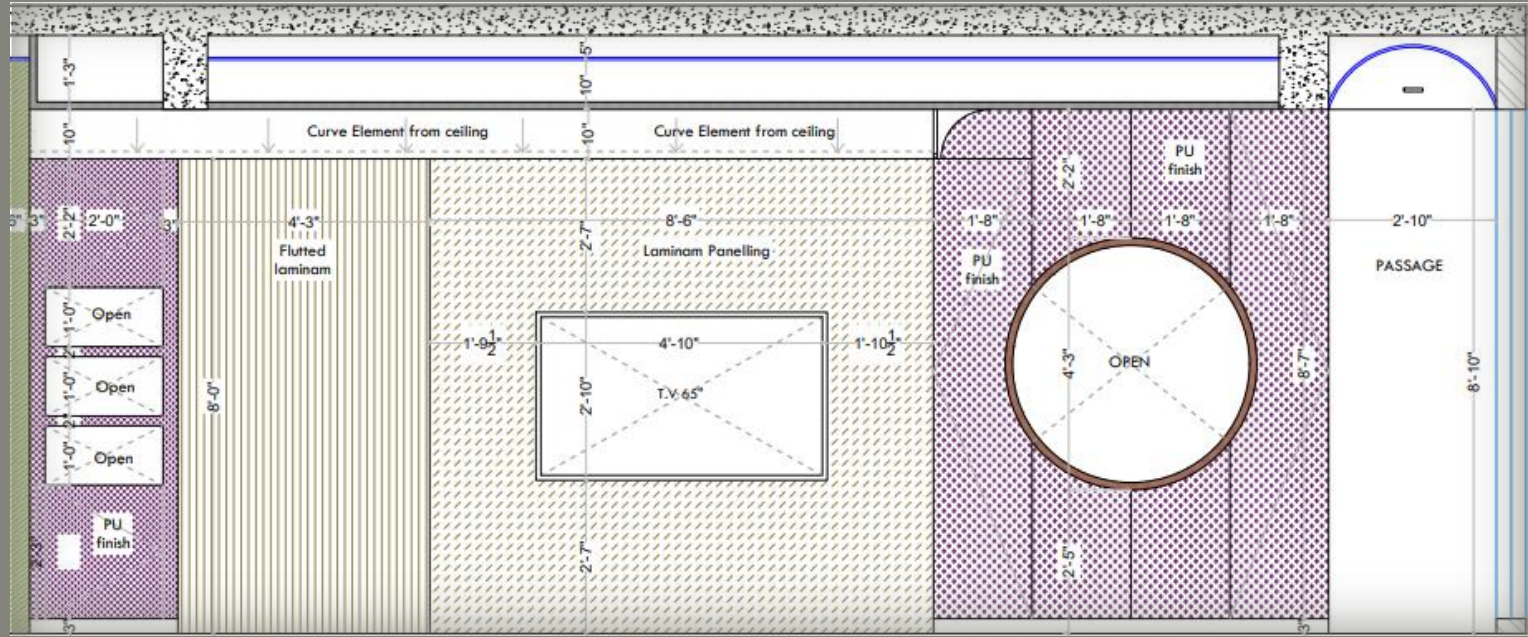

FOMRMAL LVING AREA



FOMRMAL LIVING AREA



FORMAL LIVING AREA

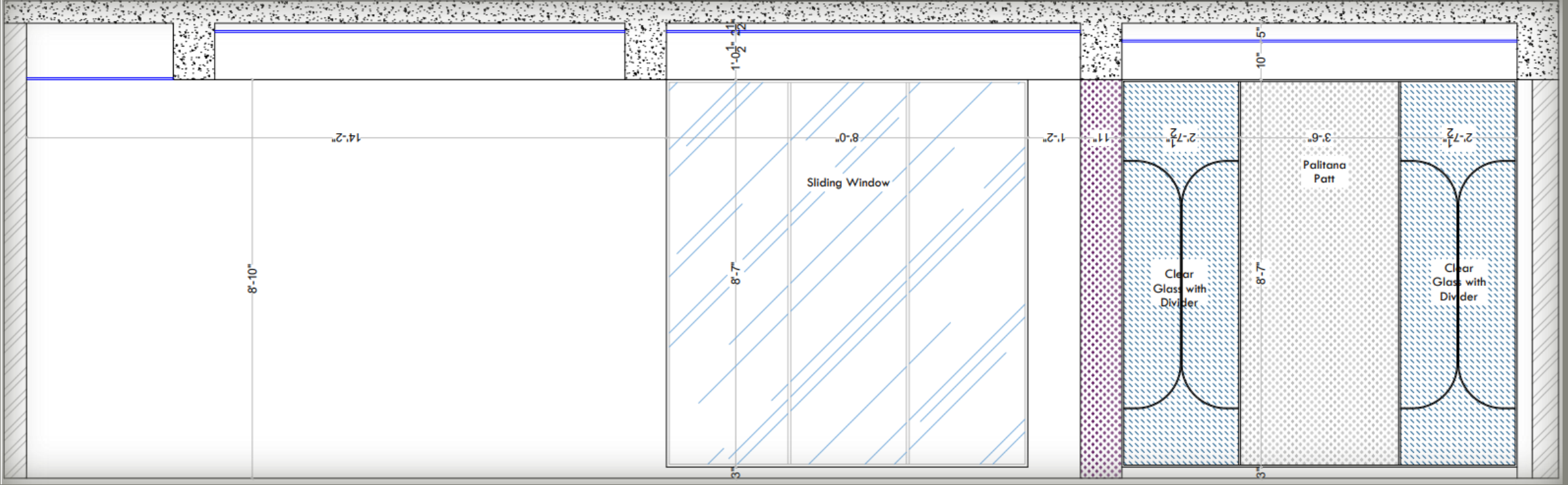

FOMRMAL LVING AREA



FOMRMAL LVING AREA



FOMRMAL LIVING AREA



DINING AREA

DINING AREA

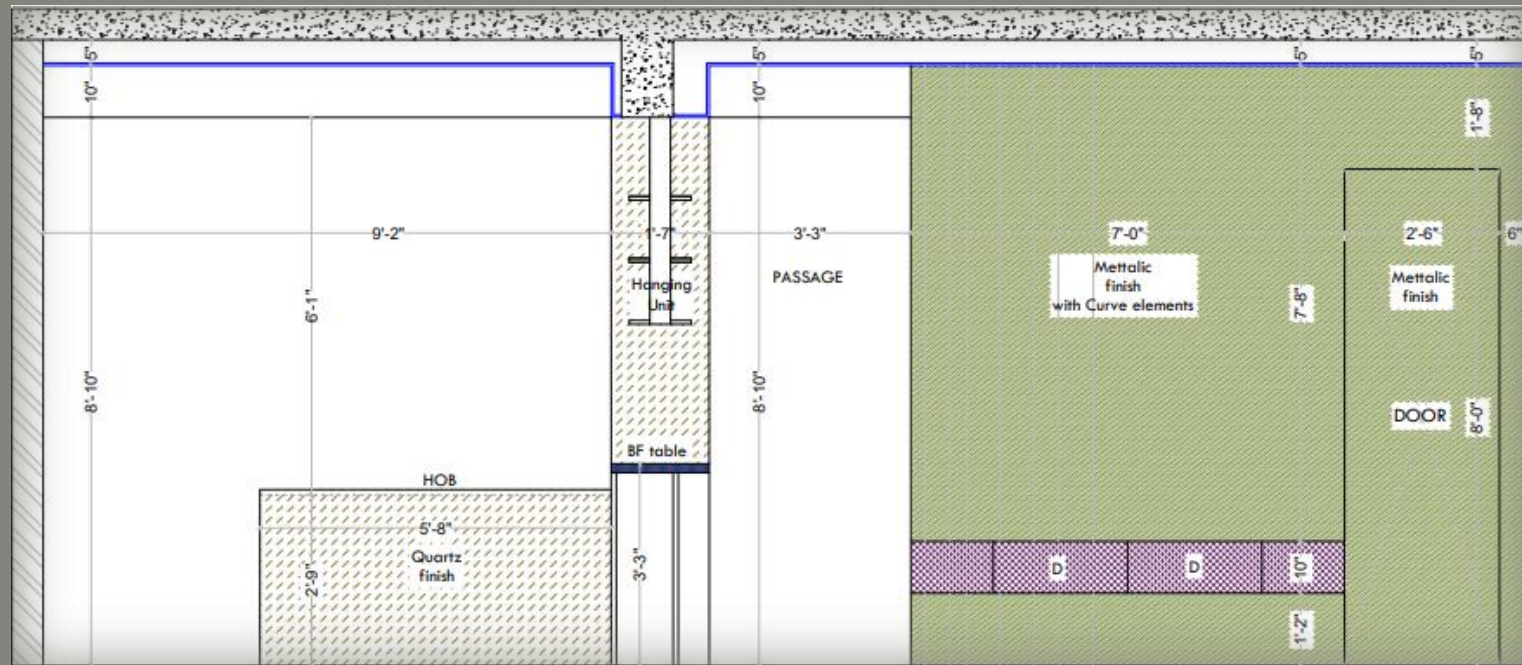
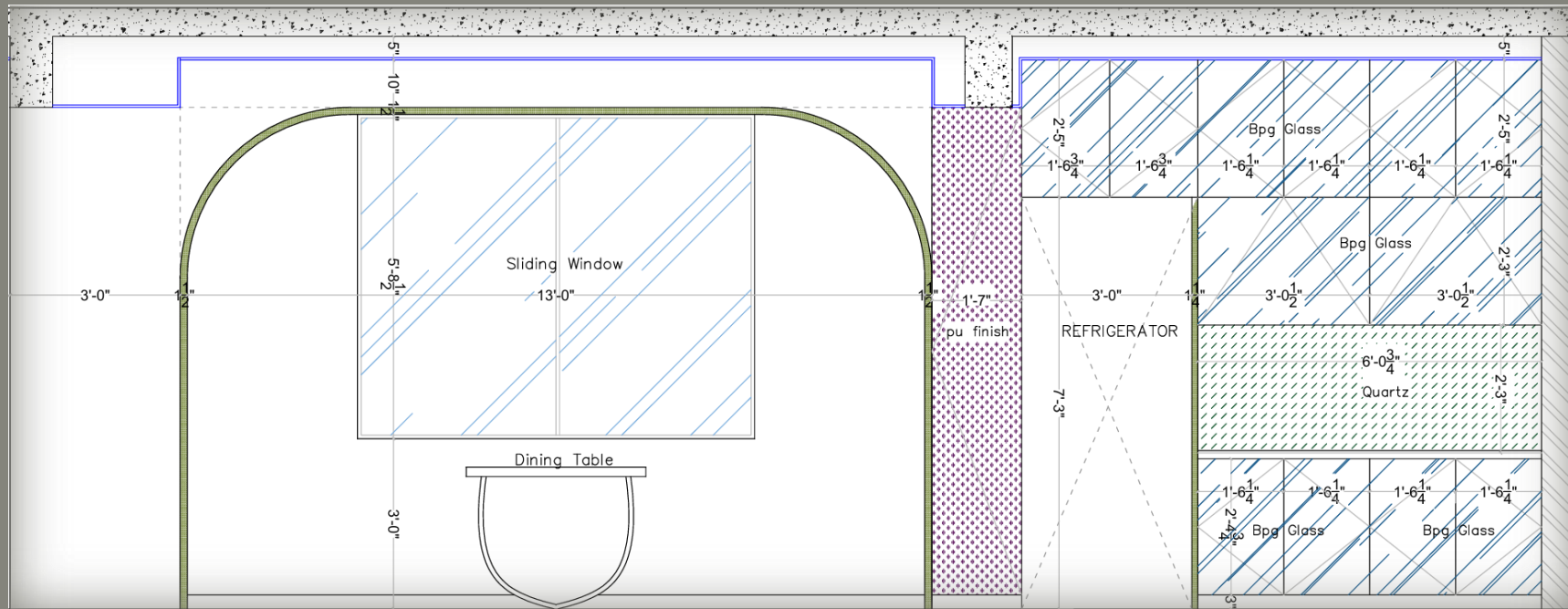

DINING AREA



DINING AREA



DINING AREA



DINING AREA

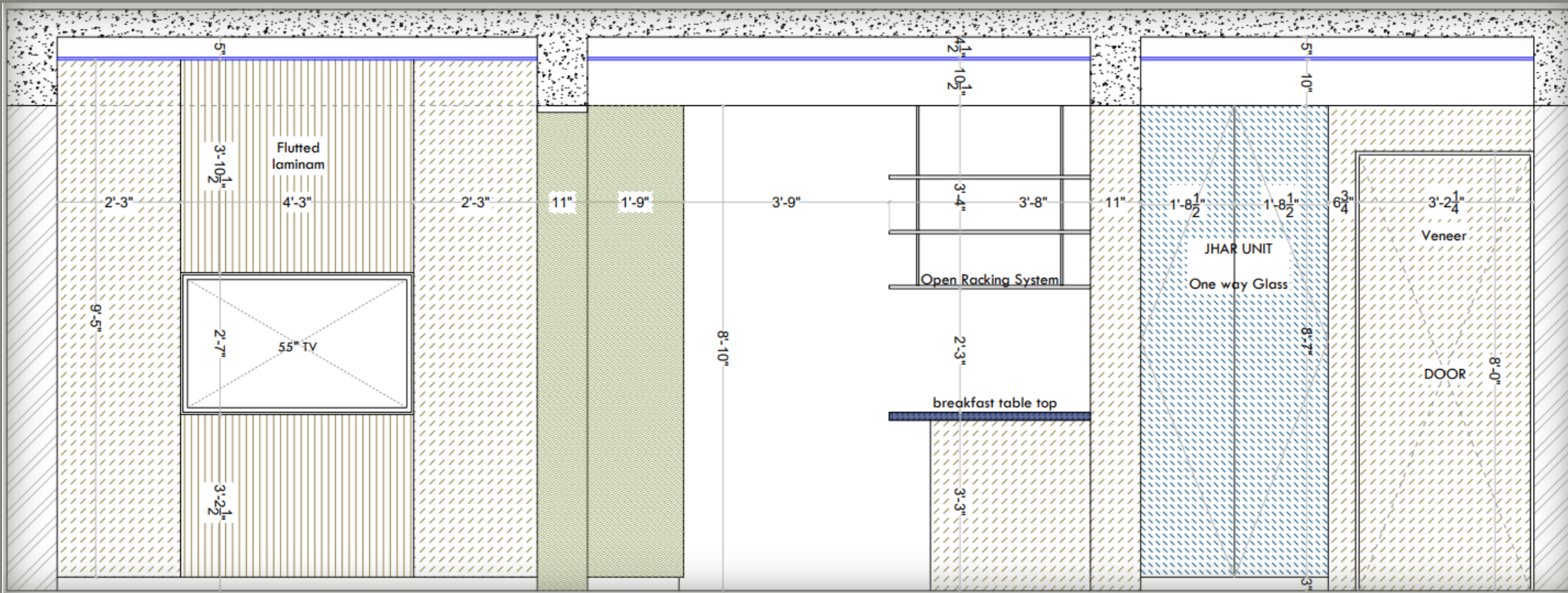

DINING AREA



DINING AREA

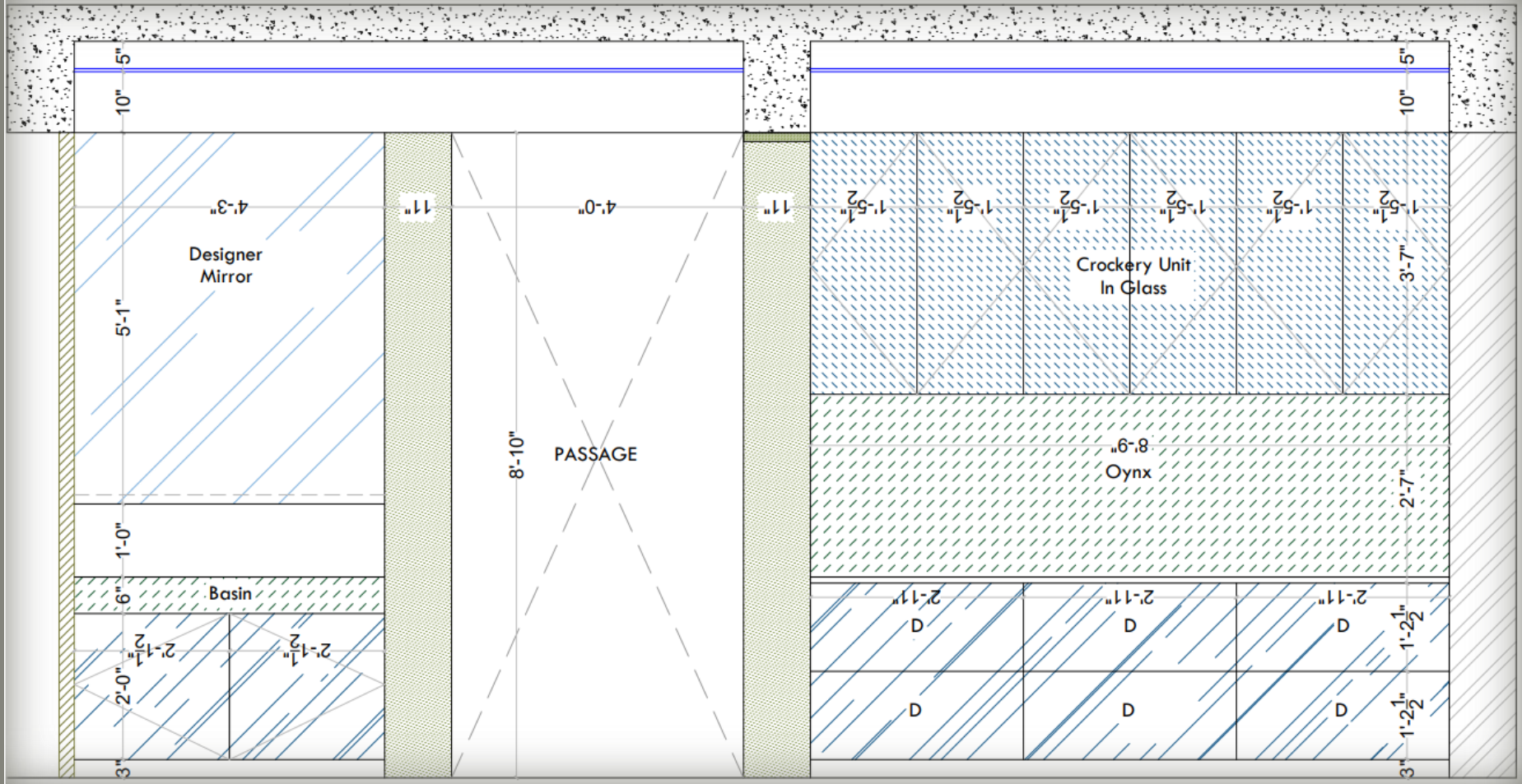

DINING AREA



DINING AREA



KITCHEN

KITCHEN



KITCHEN

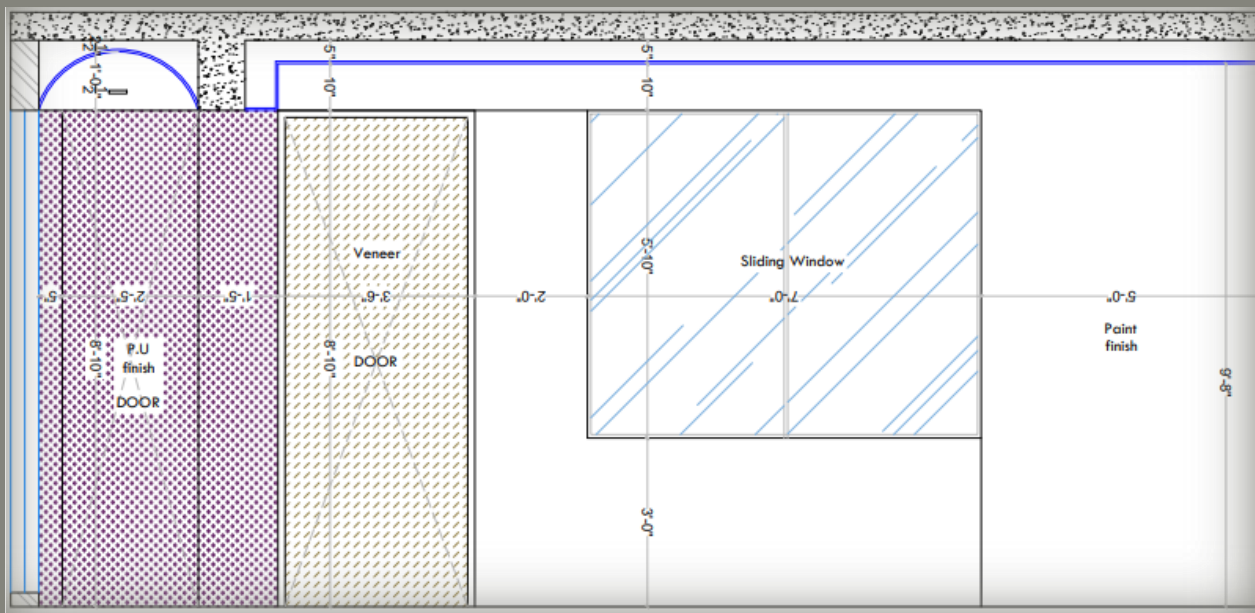
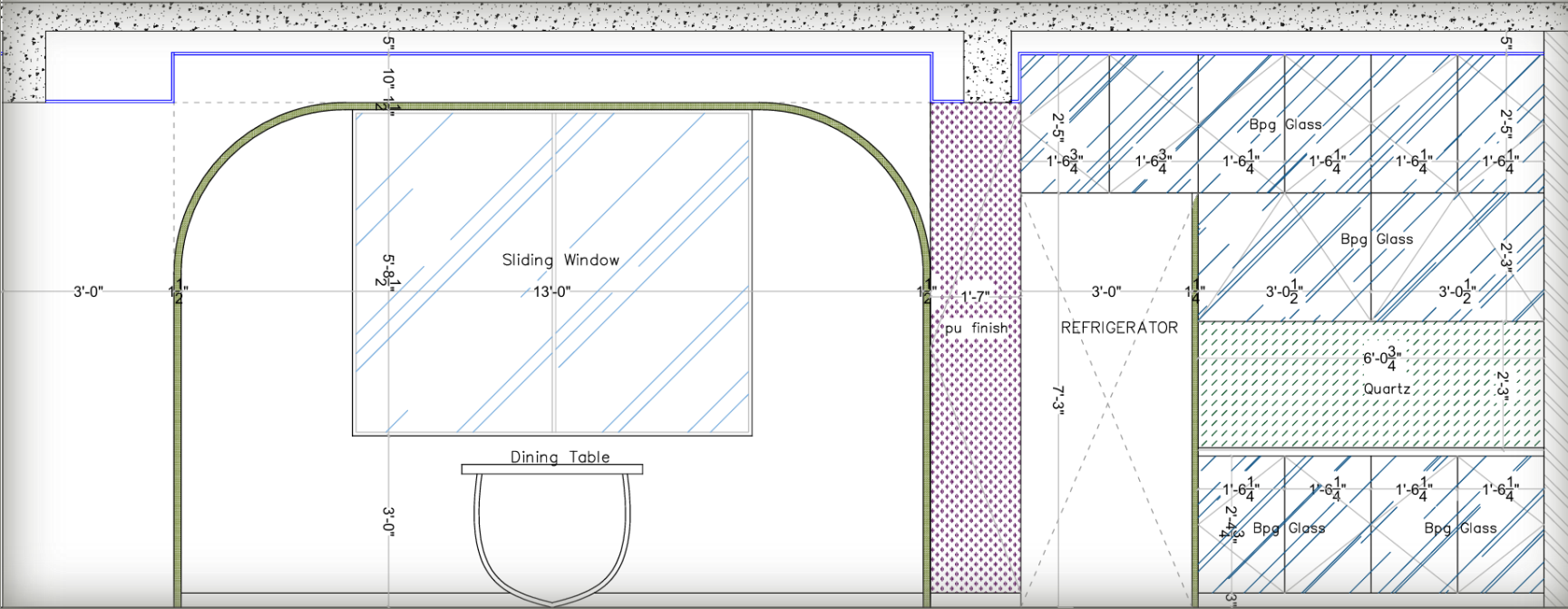

KITCHEN



KITCHEN

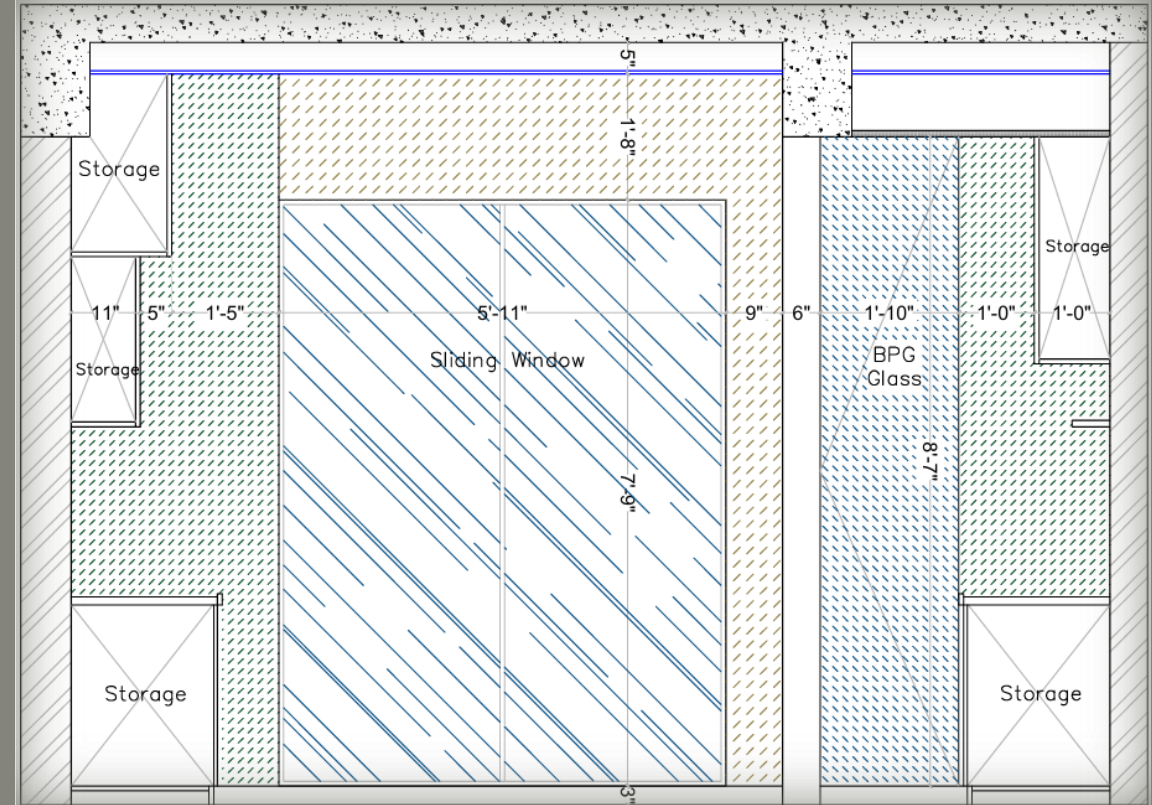
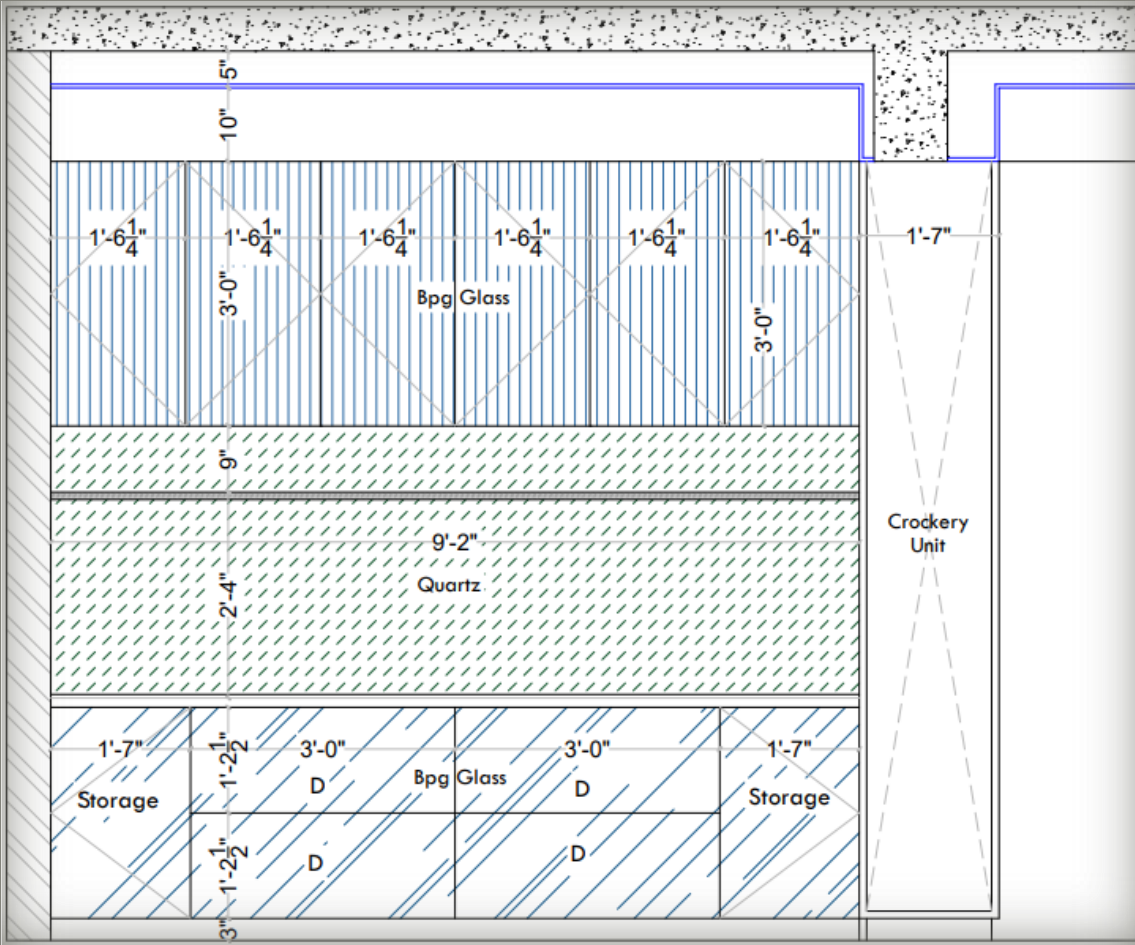

KITCHEN



KITCHEN



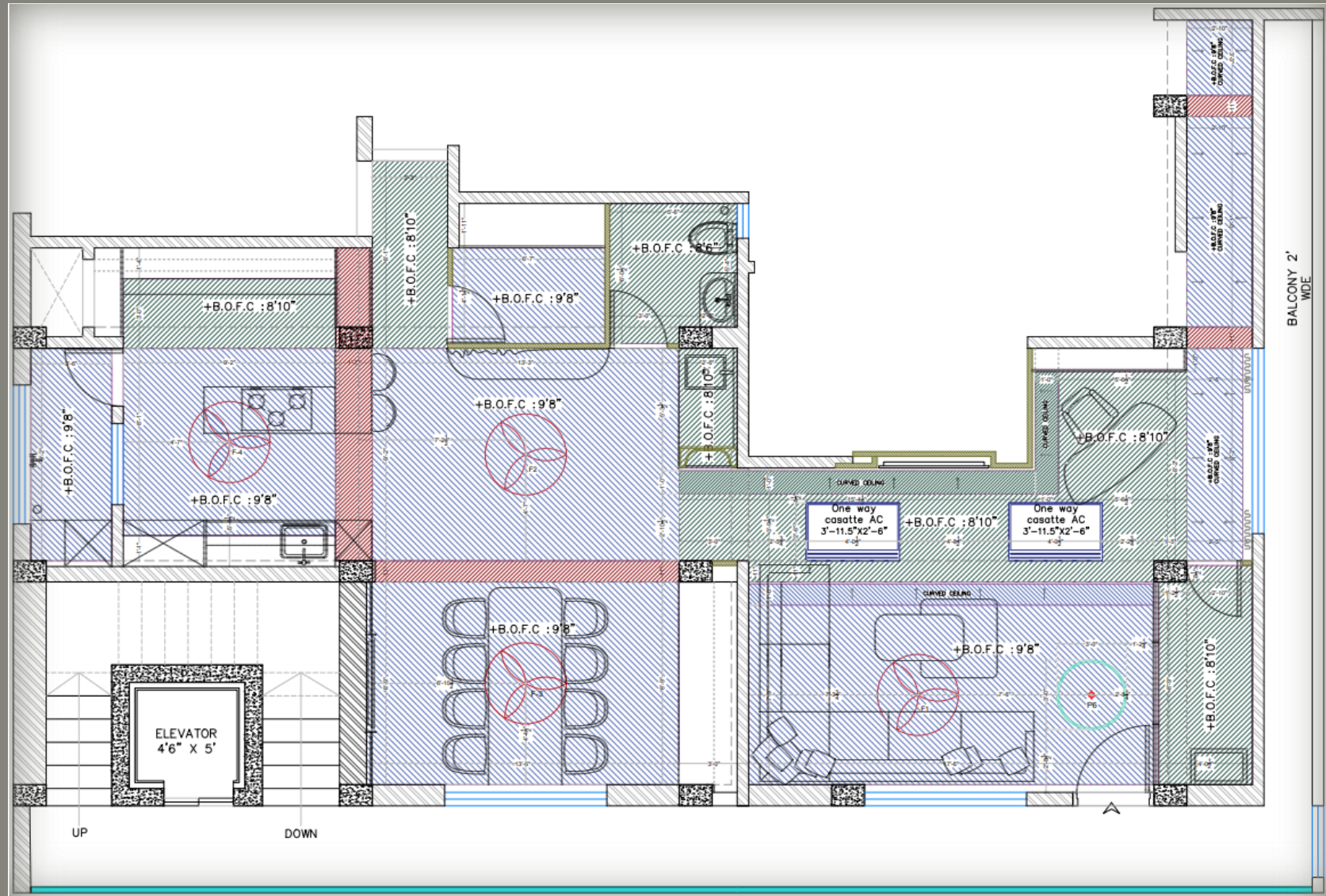

CEILING LAYOUT

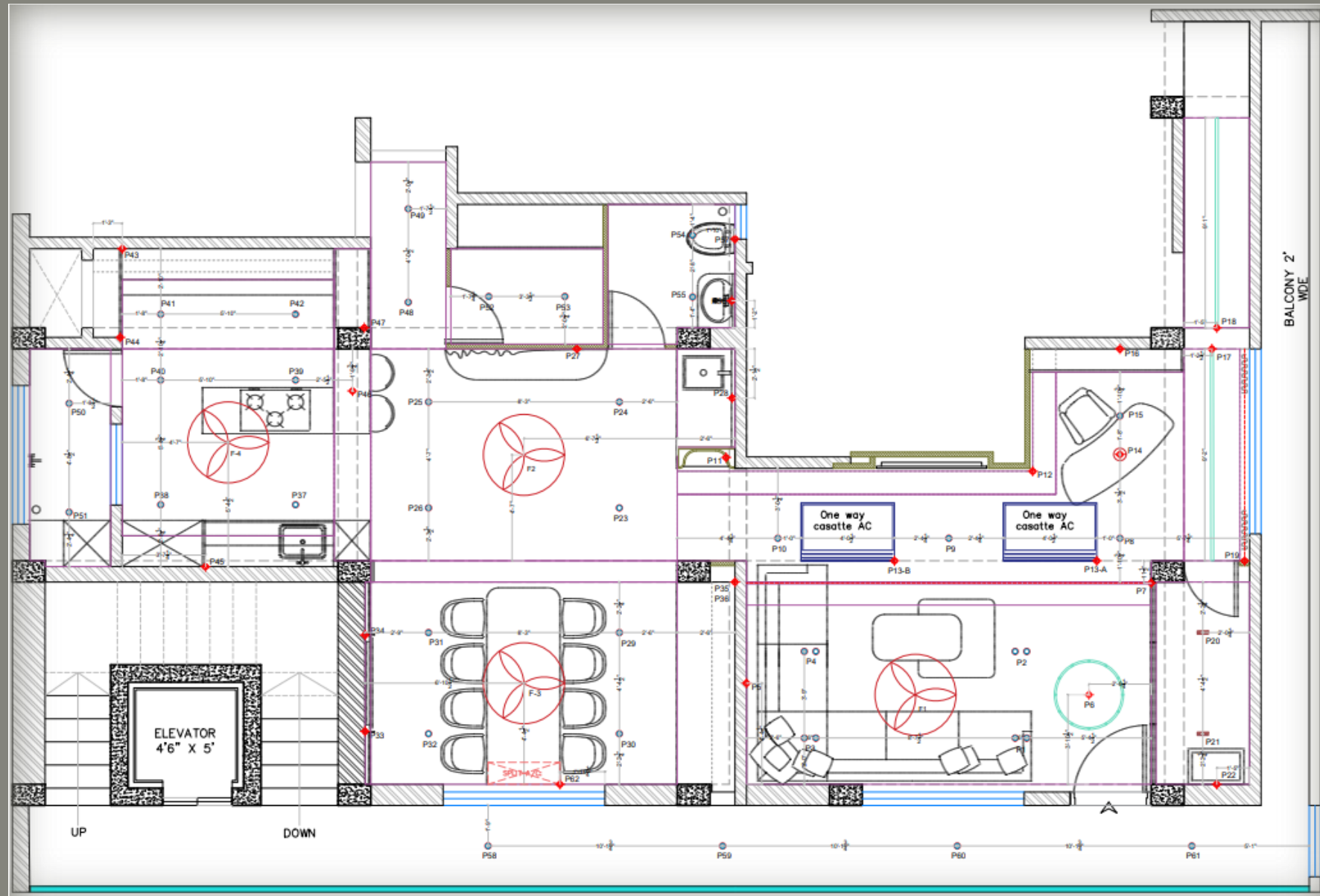

ELECTRICAL LAYOUT

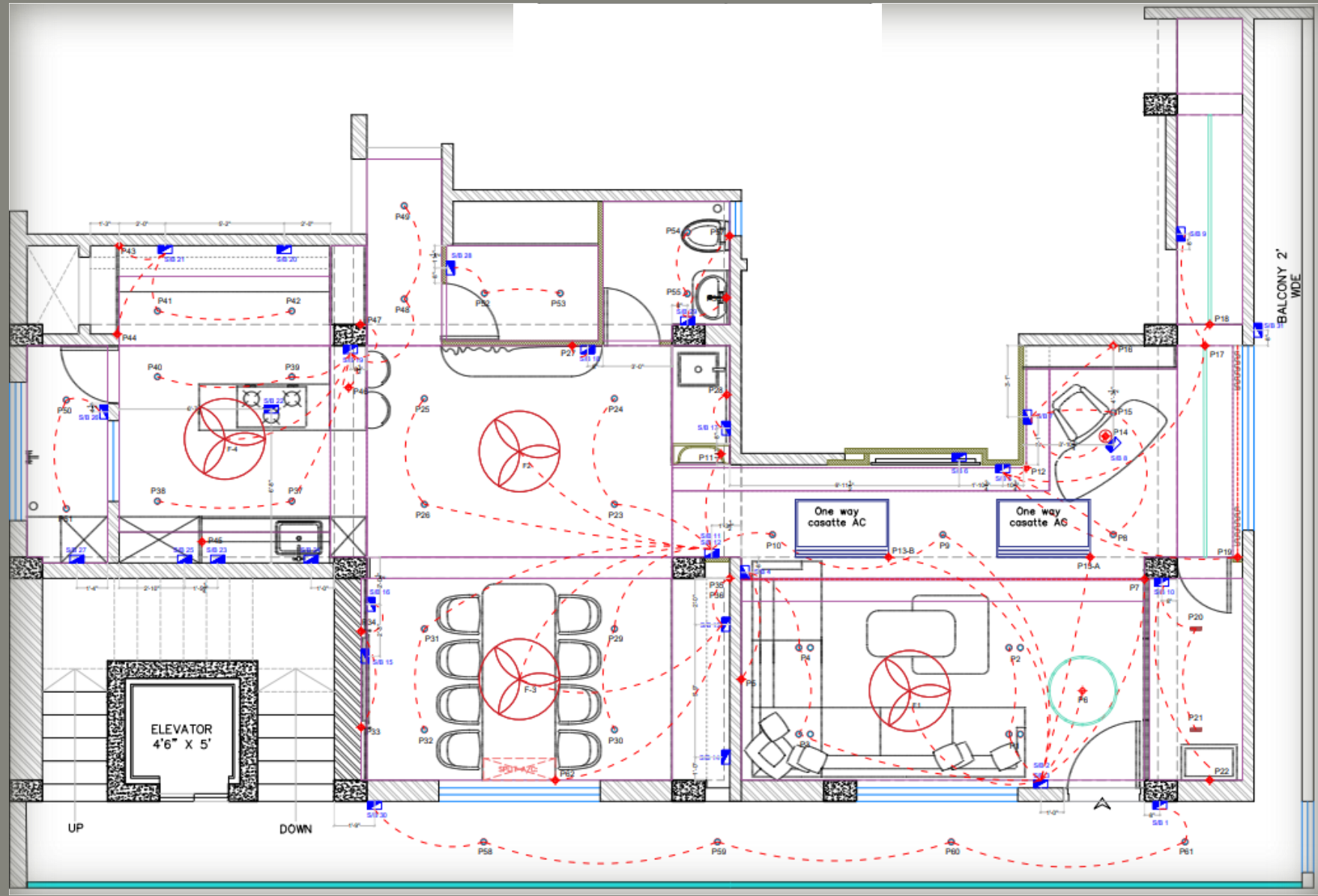

ELECTRICAL LOOPING LAYOUT

MASTER BEDROOM 01

MASTER BEDROOM

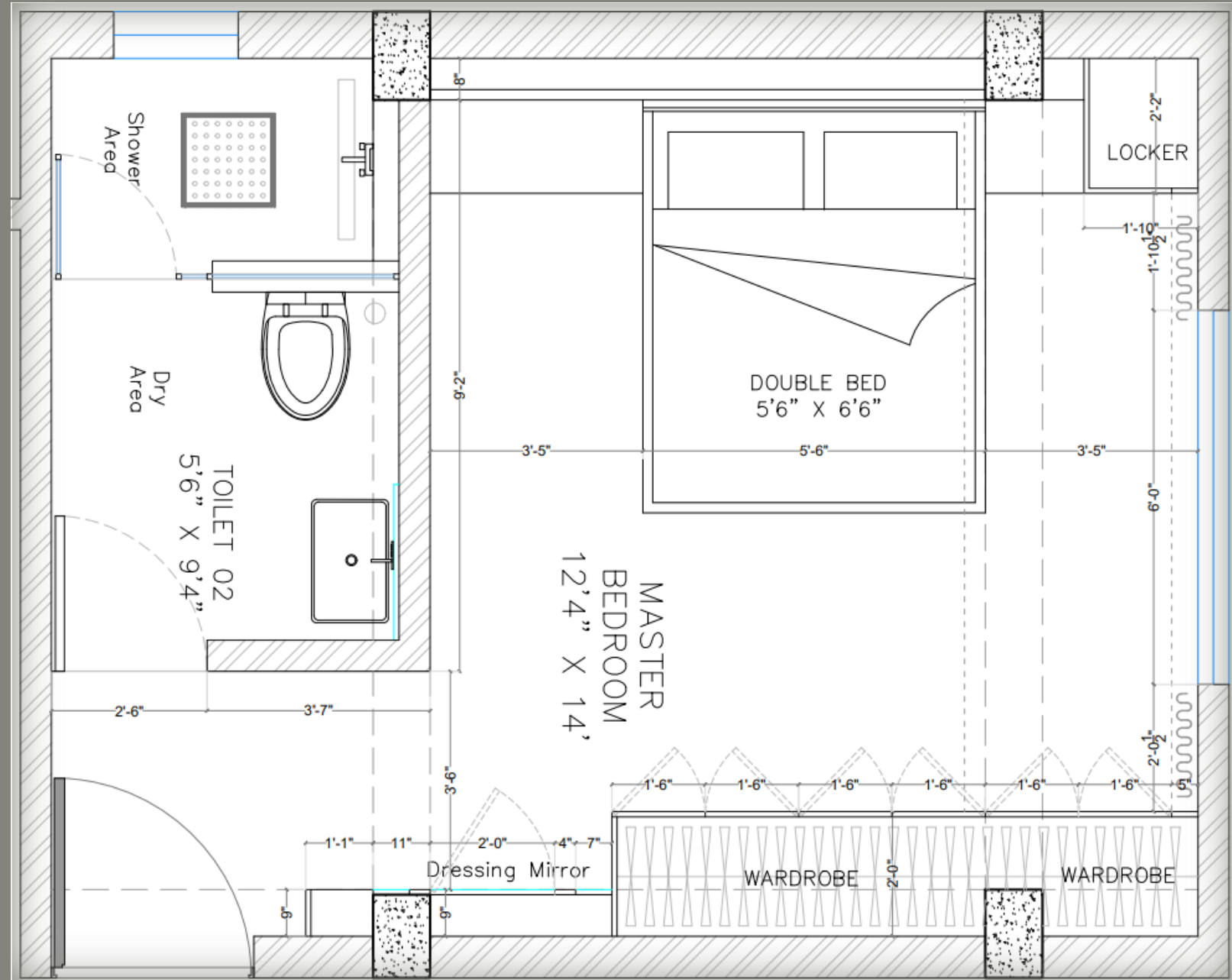

MASTER BEDROOM

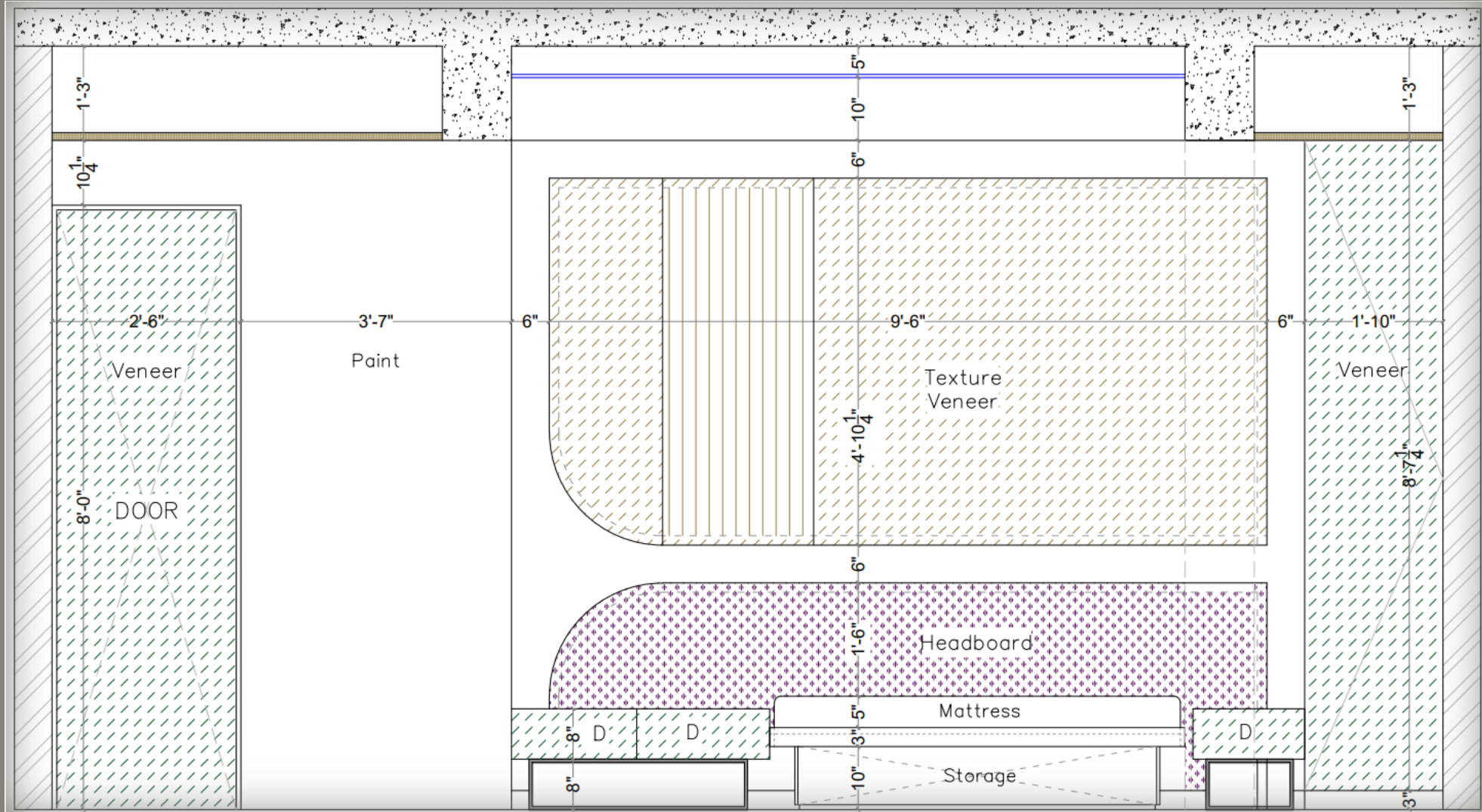

MASTER BEDROOM

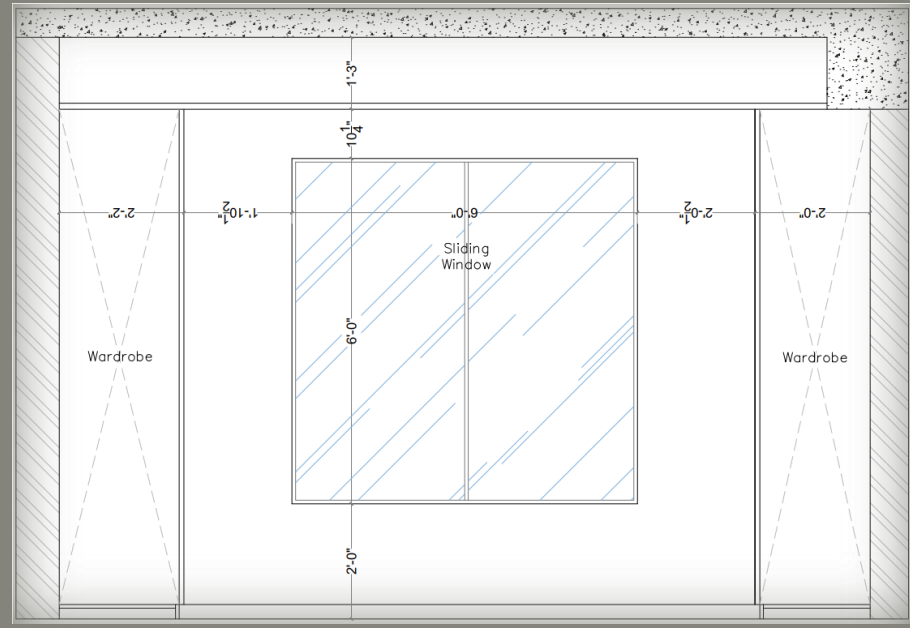
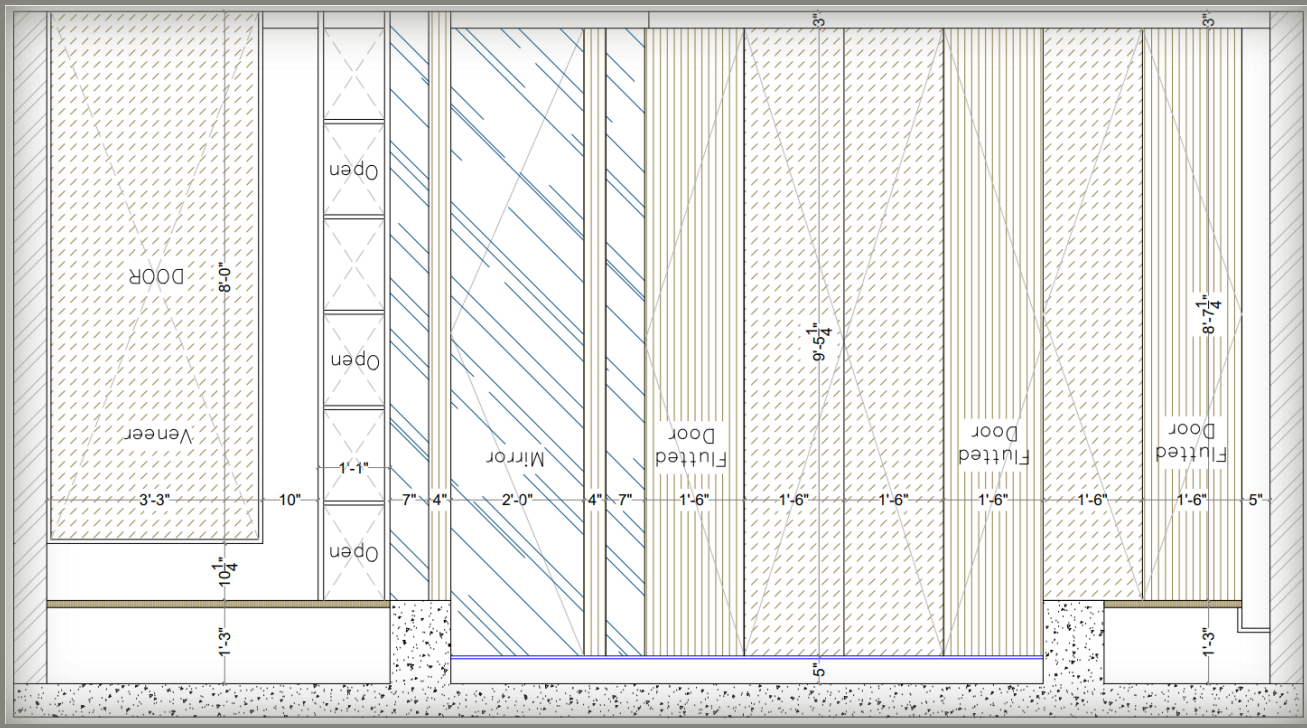

MASTER BEDROOM



MASTER BEDROOM



MASTER BEDROOM



MASTER BEDROOM



MASTER BEDROOM



MASTER BEDROOM-1

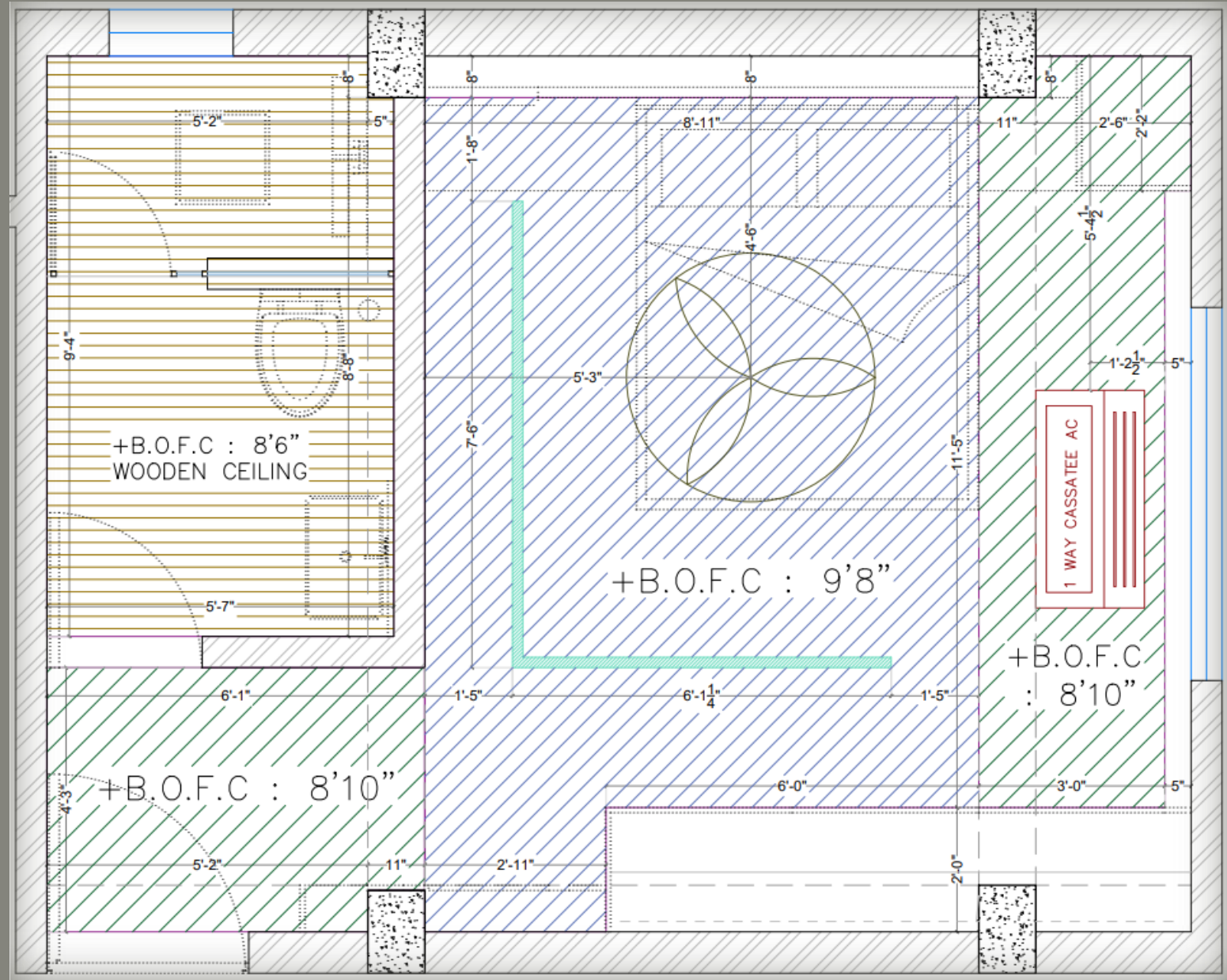

CEILING LAYOUT

MASTER BEDROOM-1

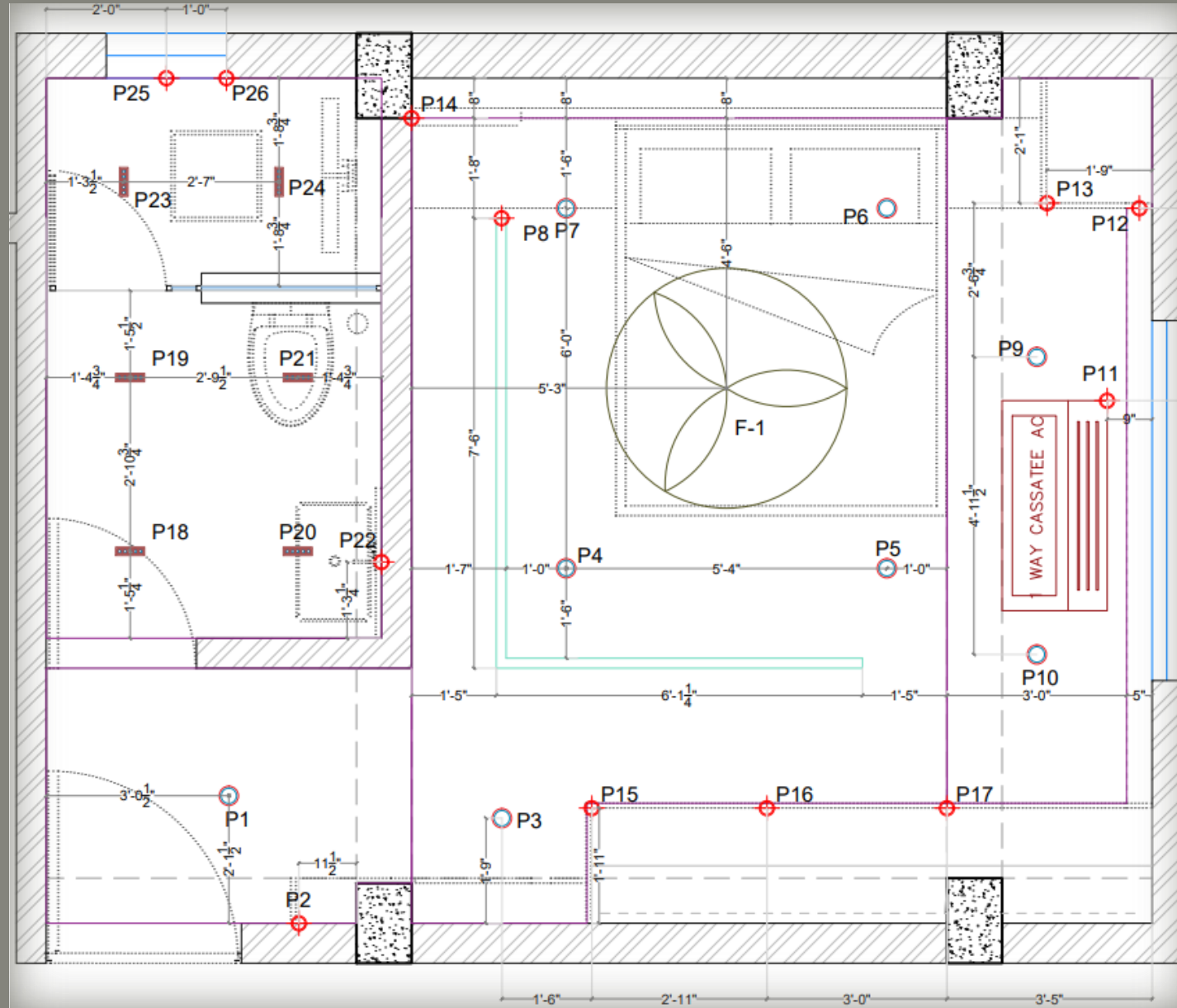

ELECTRICAL LAYOUT

MASTER BEDROOM-1

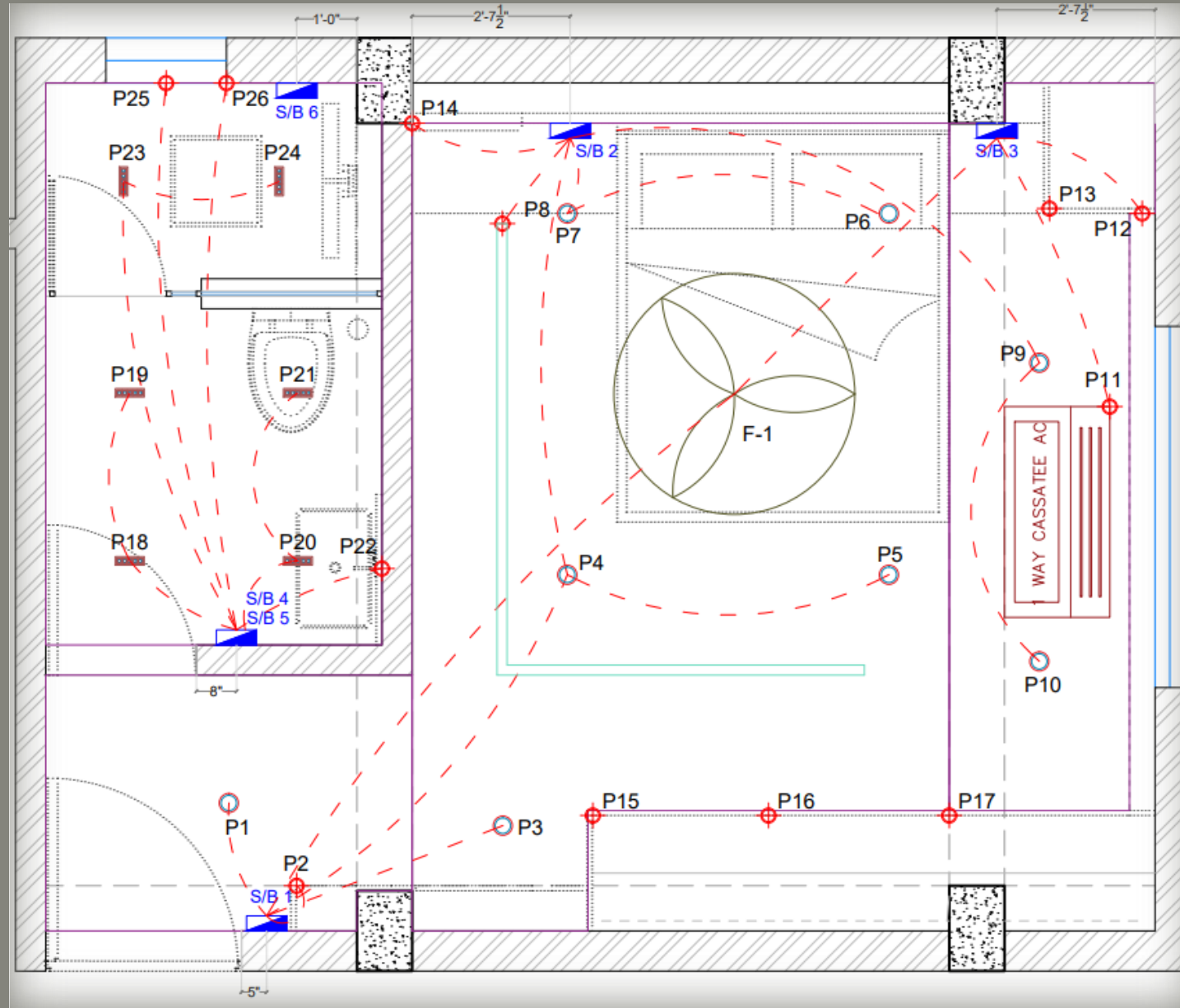

ELECTRICAL LOOPING LAYOUT

MASTER BATHROOM-01

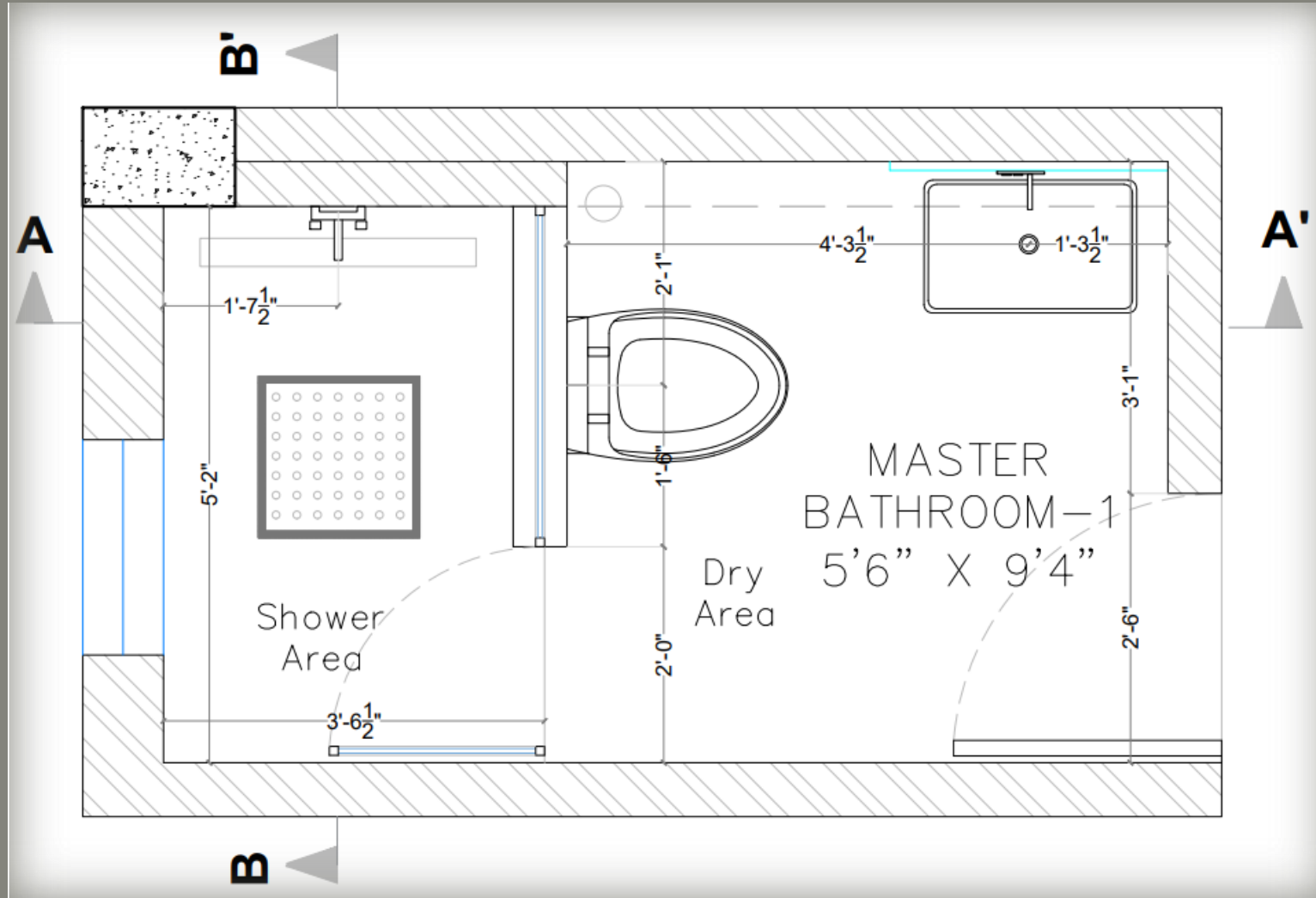

BATHROOM LAYOUT

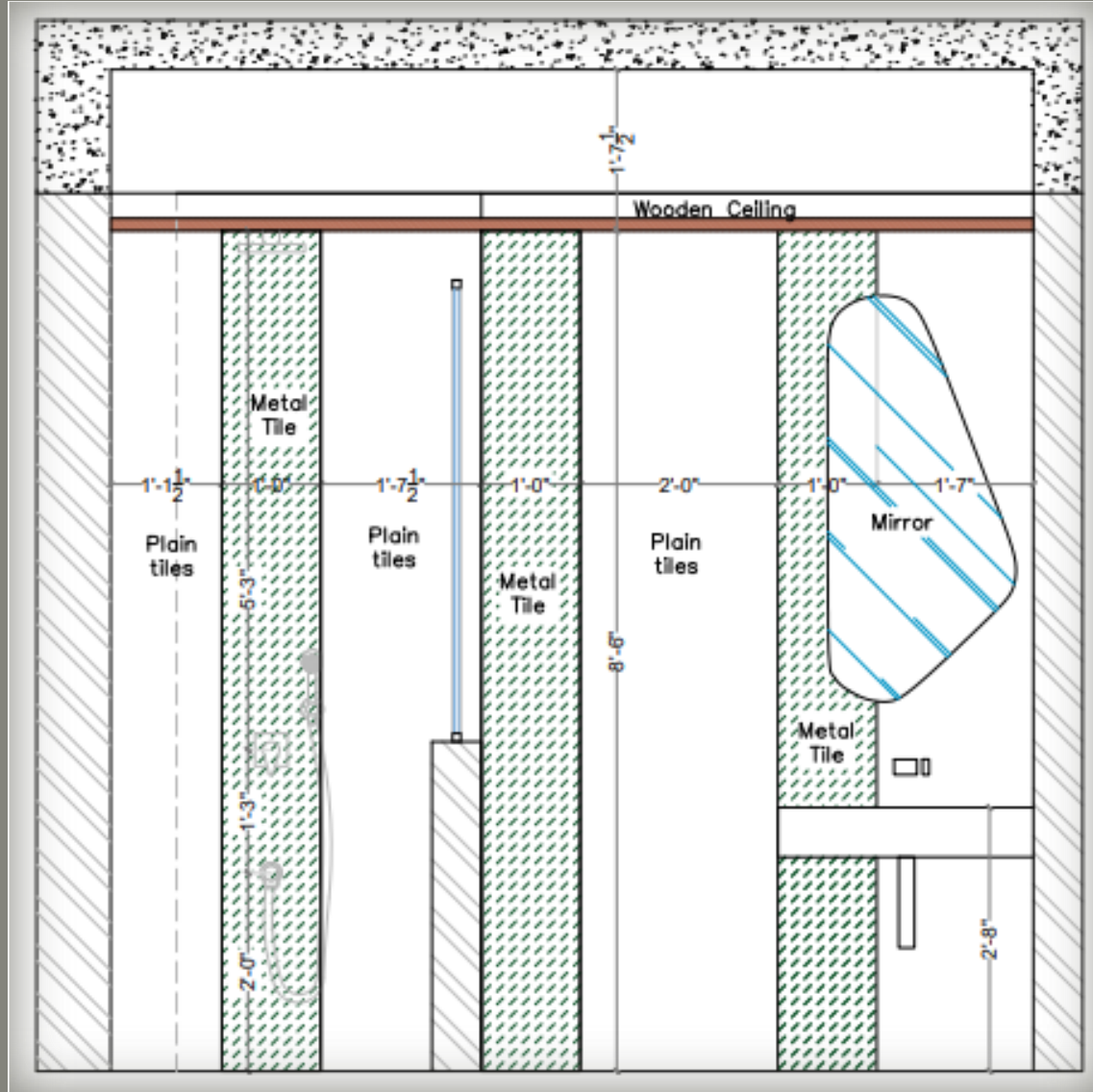

ELEVATION-AA'

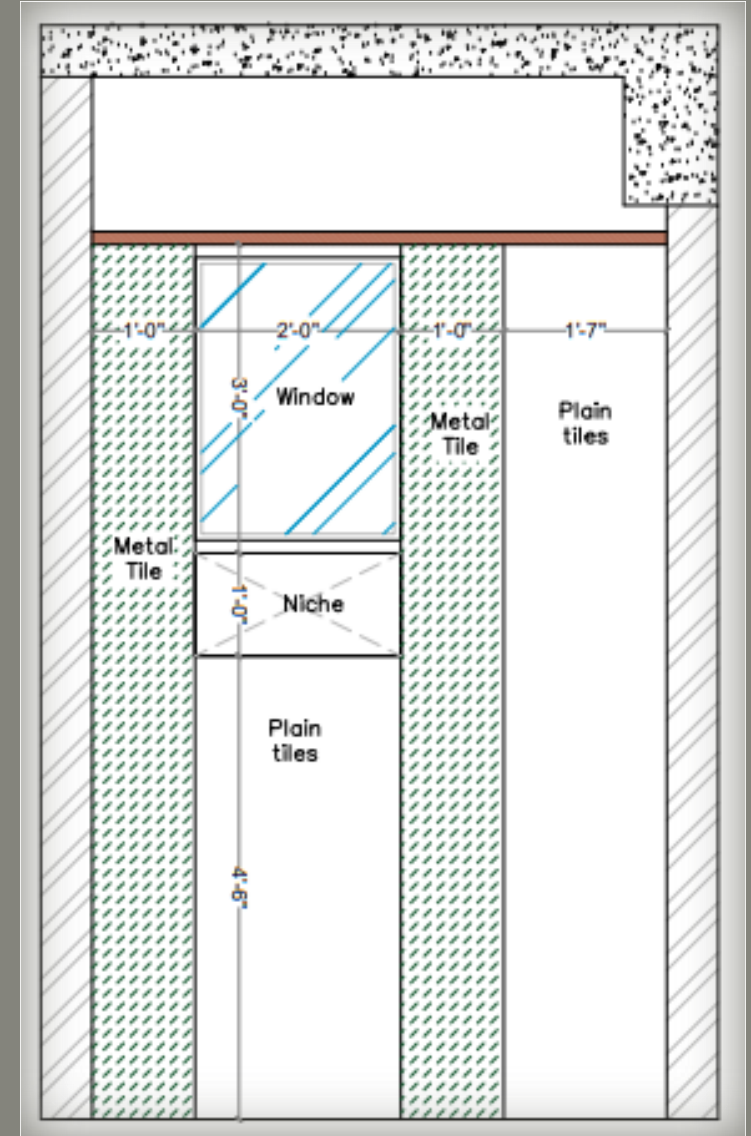

ELEVATION-BB'

MASTER BATHROOM-1



MASTER BATHROOM-1



MASTER BEDROOM 02

MASTER BEDROOM 02

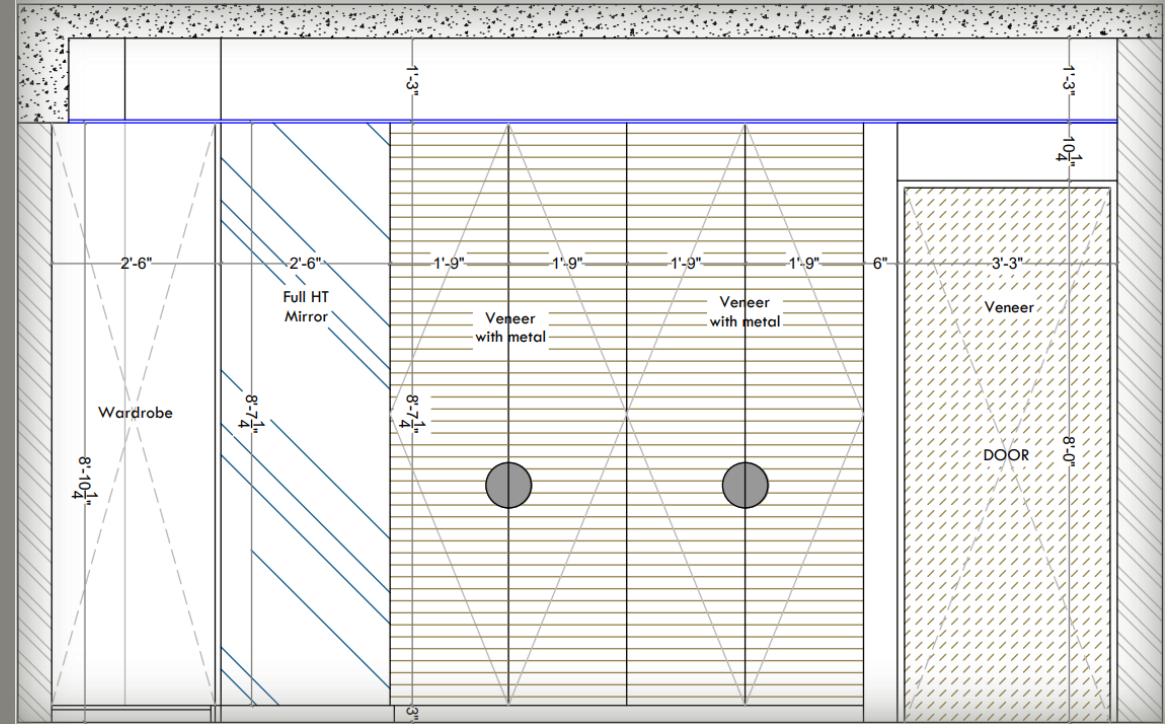
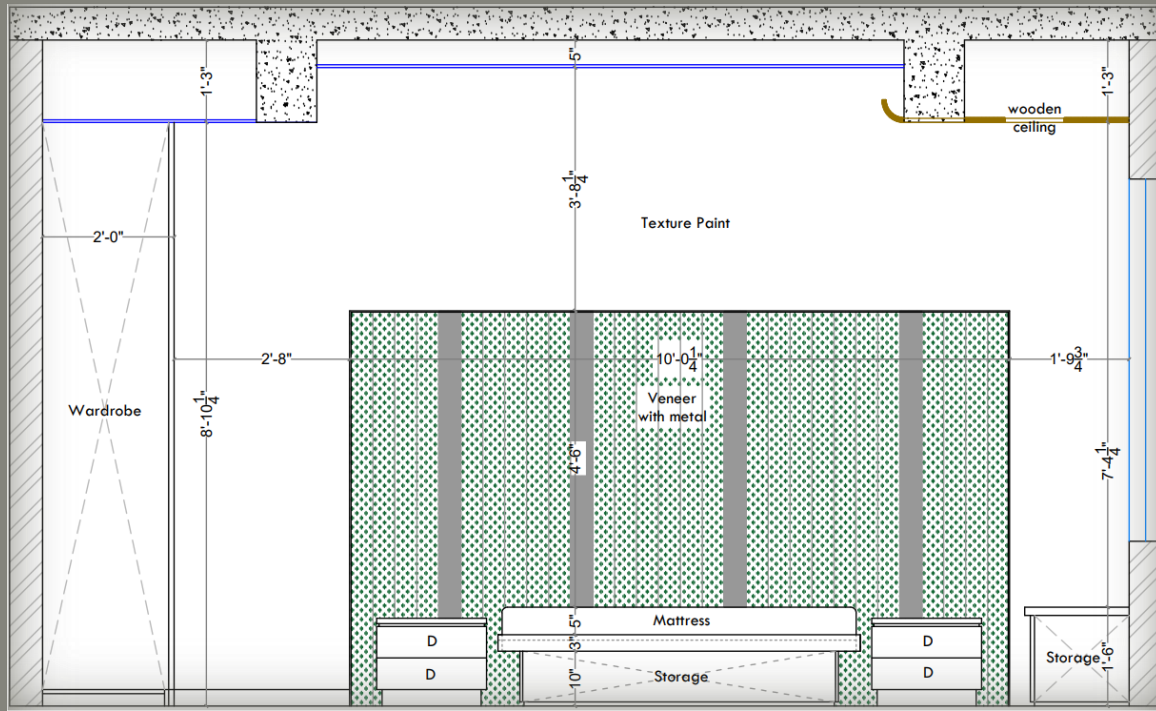

MASTER BEDROOM 02



MASTER BEDROOM 02



MASTER BEDROOM 02

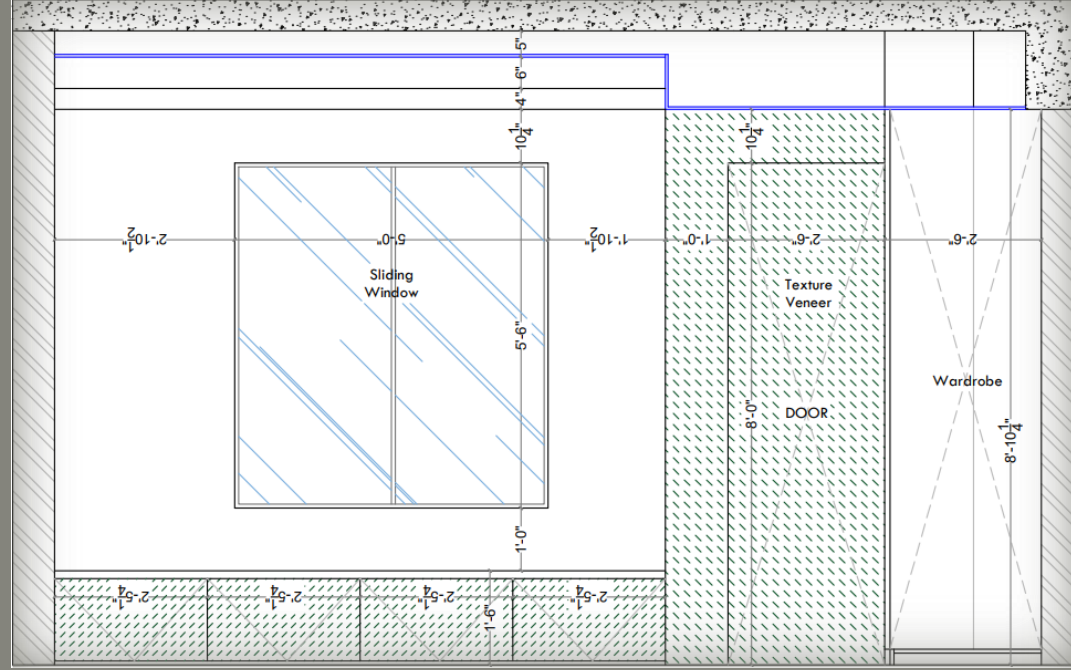
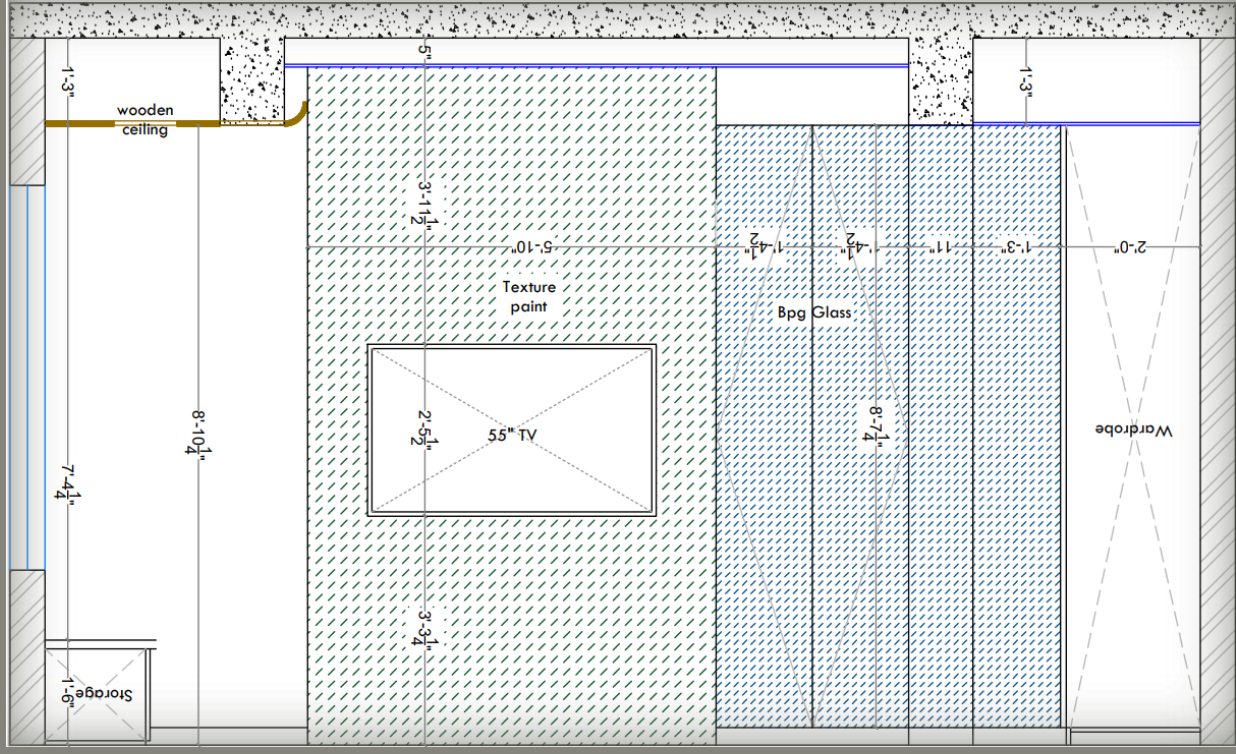

MASTER BEDROOM 02



MASTER BEDROOM 02



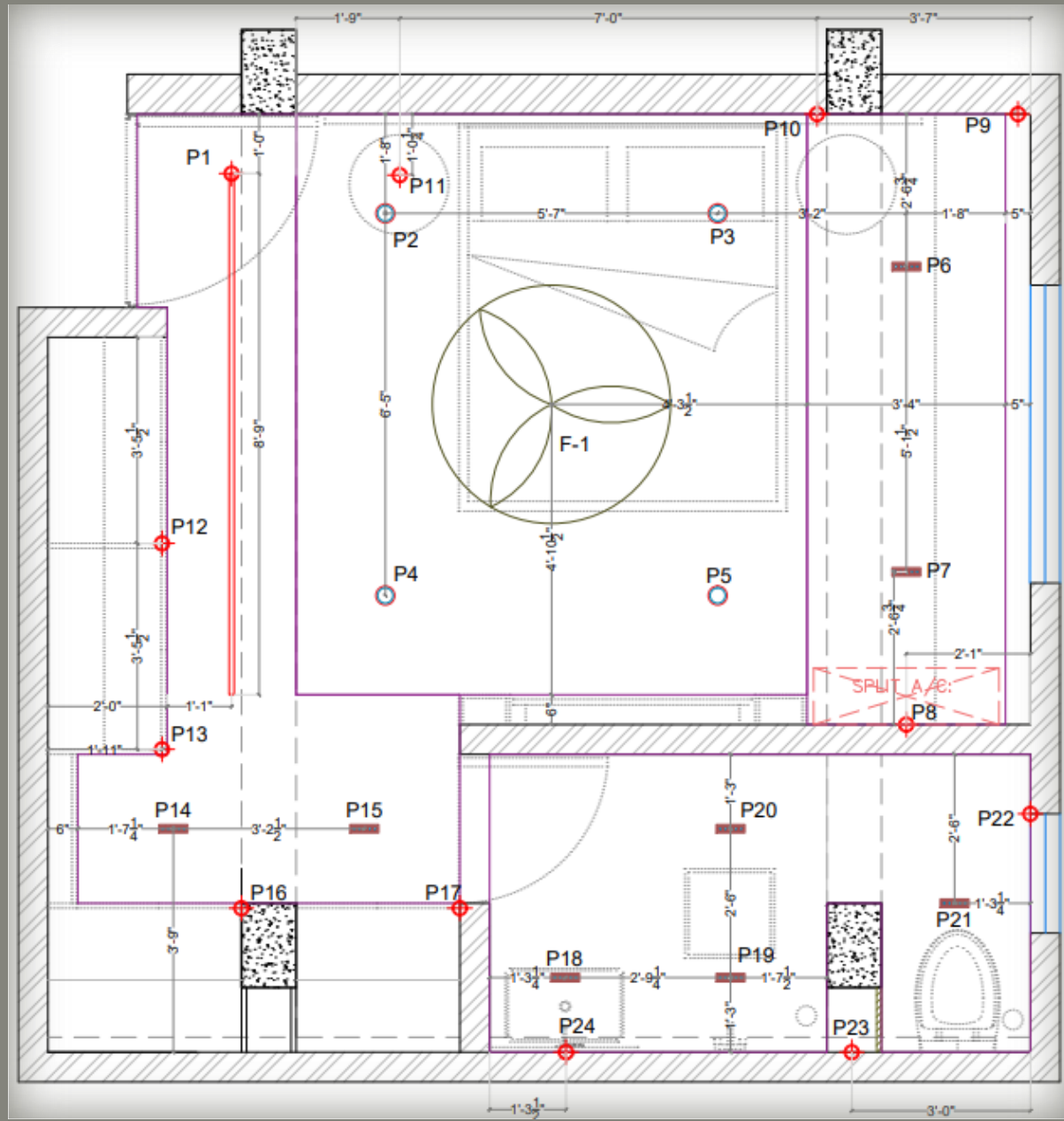

ELECTRICAL LAYOUT

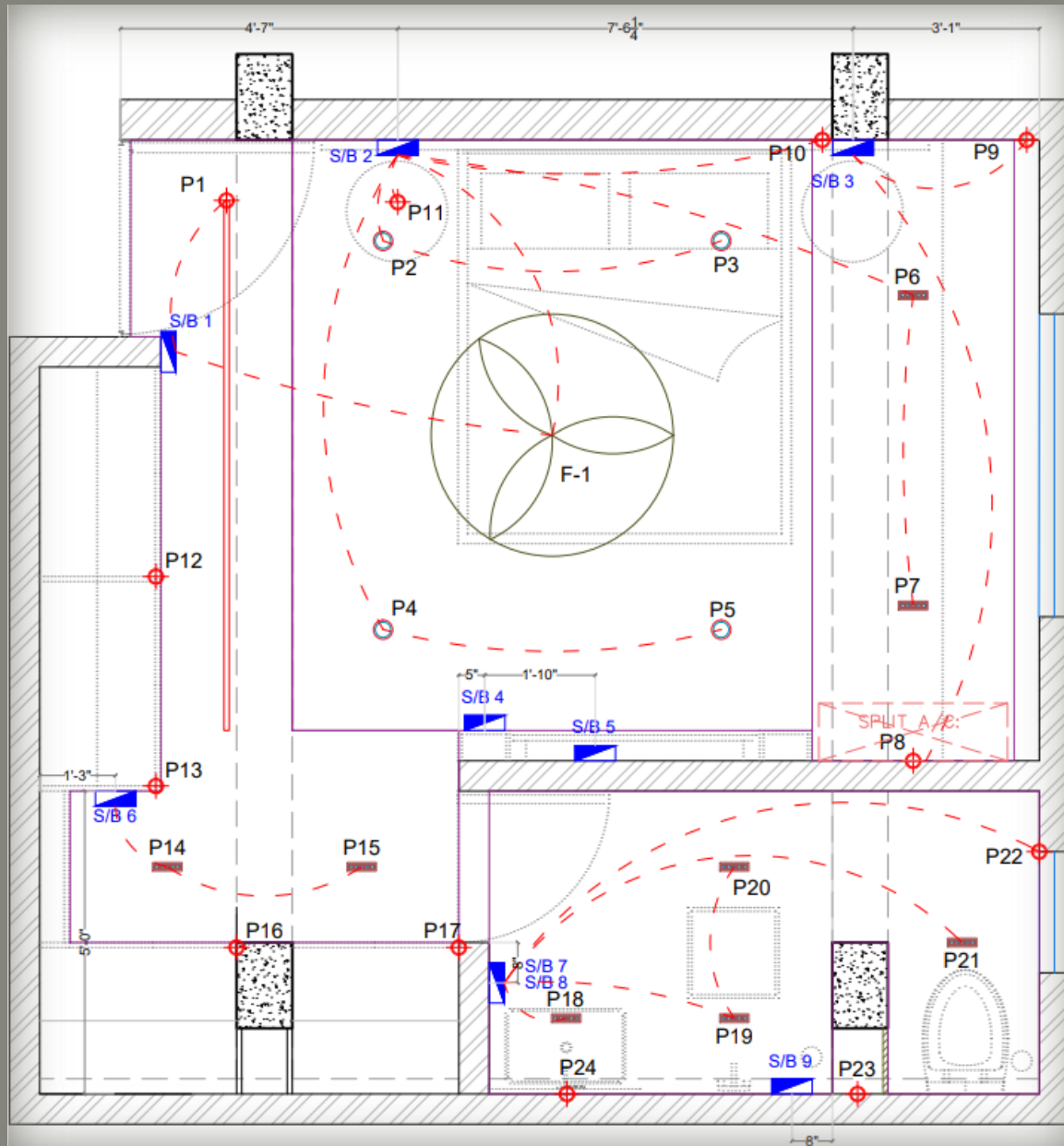

ELECTRICAL LOOPING LAYOUT

MASTER BATHROOM-02

MASTER BATHROOM-2

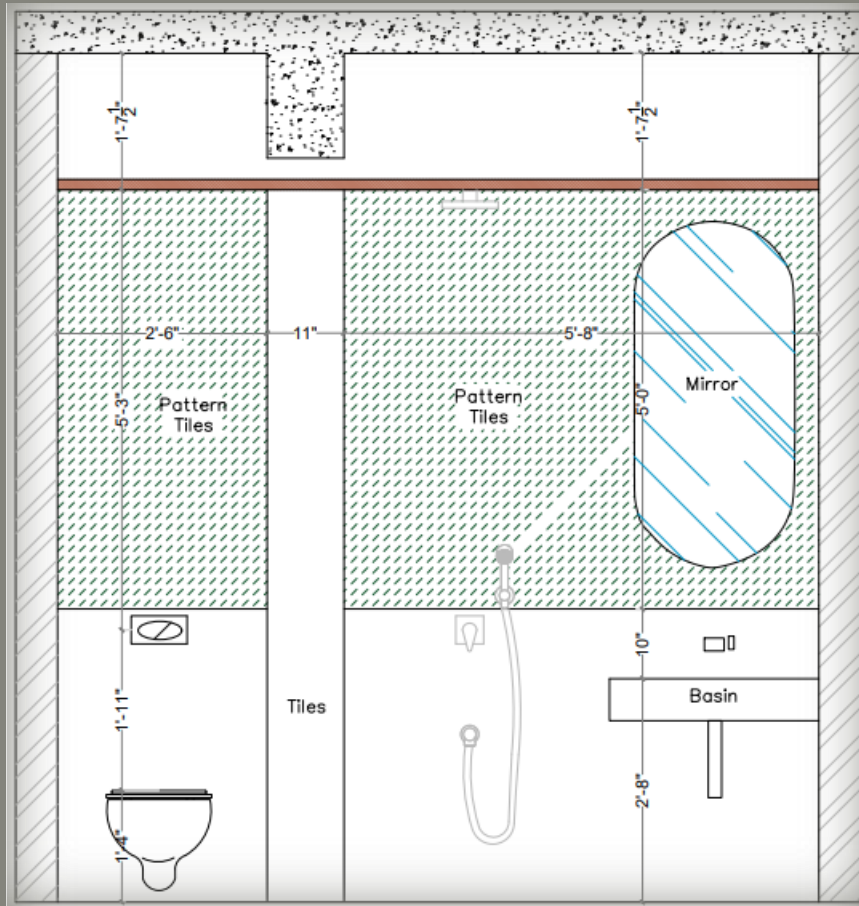

ELEVATION-AA'

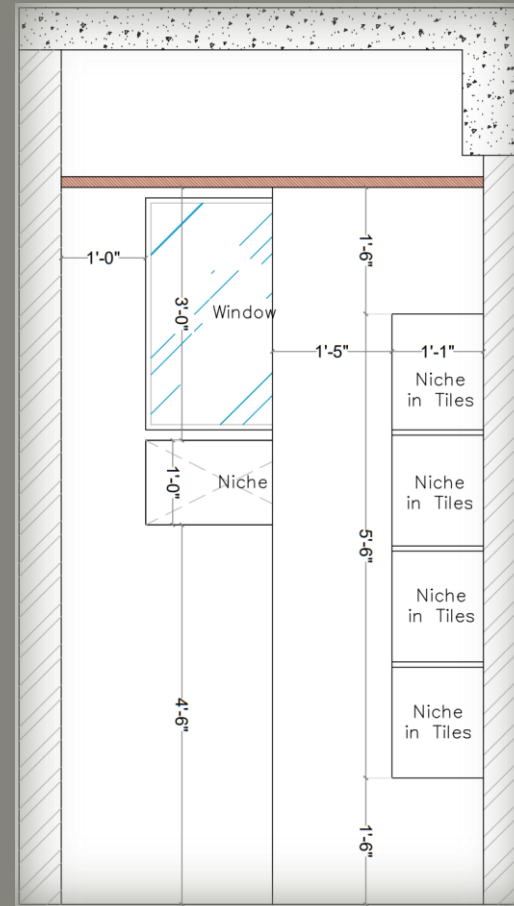

ELEVATION-BB'

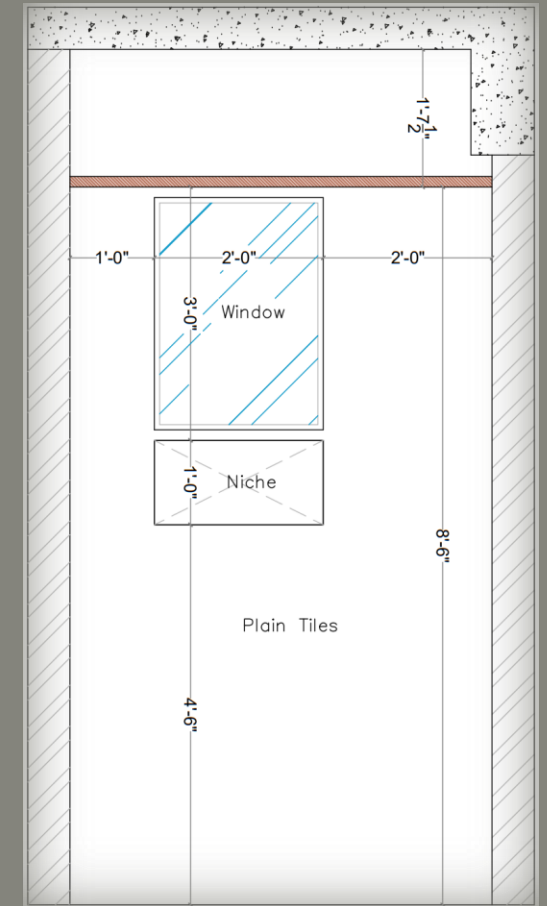

ELEVATION-CC'

MASTER BATHROOM-2



MASTER BATHROOM-2



GIRLS BEDROOM

GIRLS BEDROOM

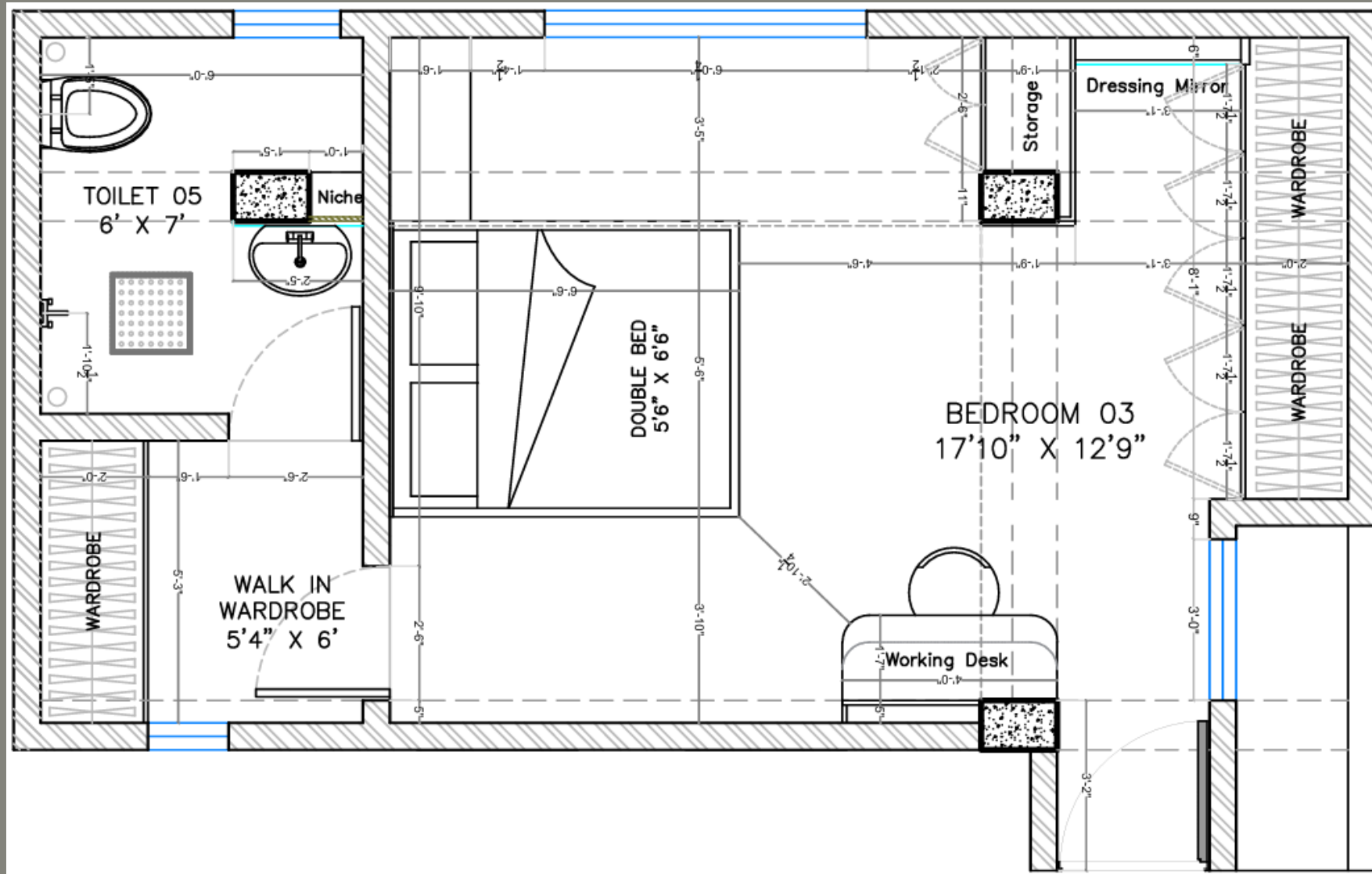

GIRLS BEDROOM

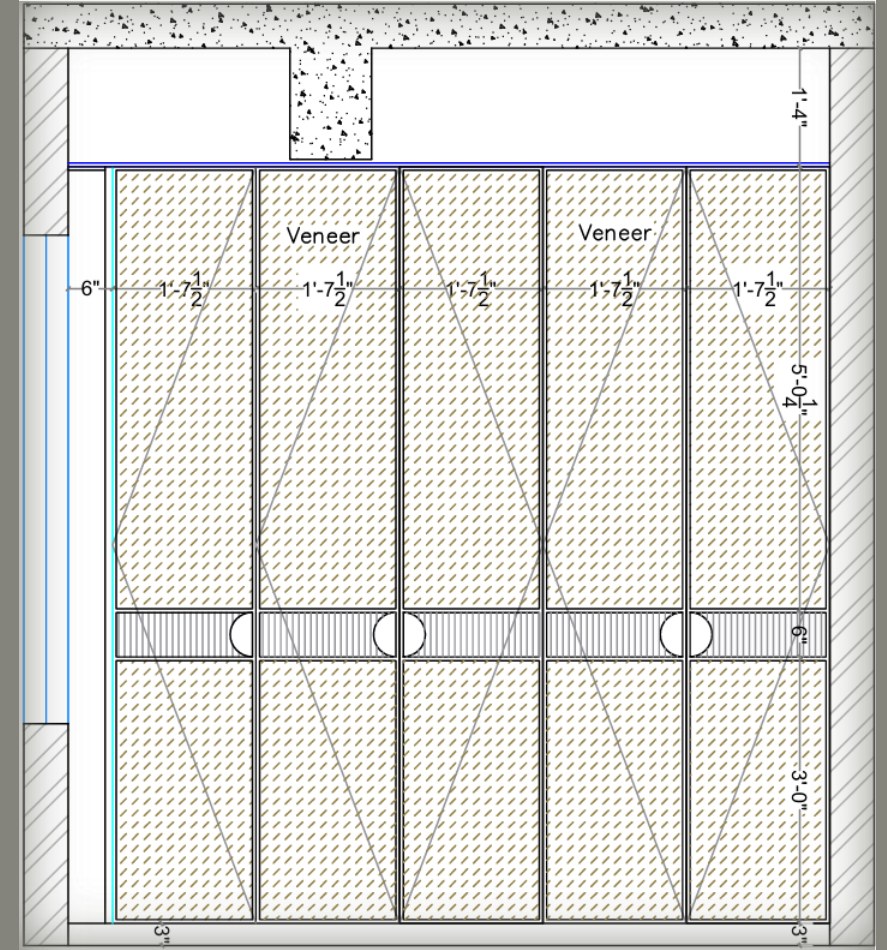
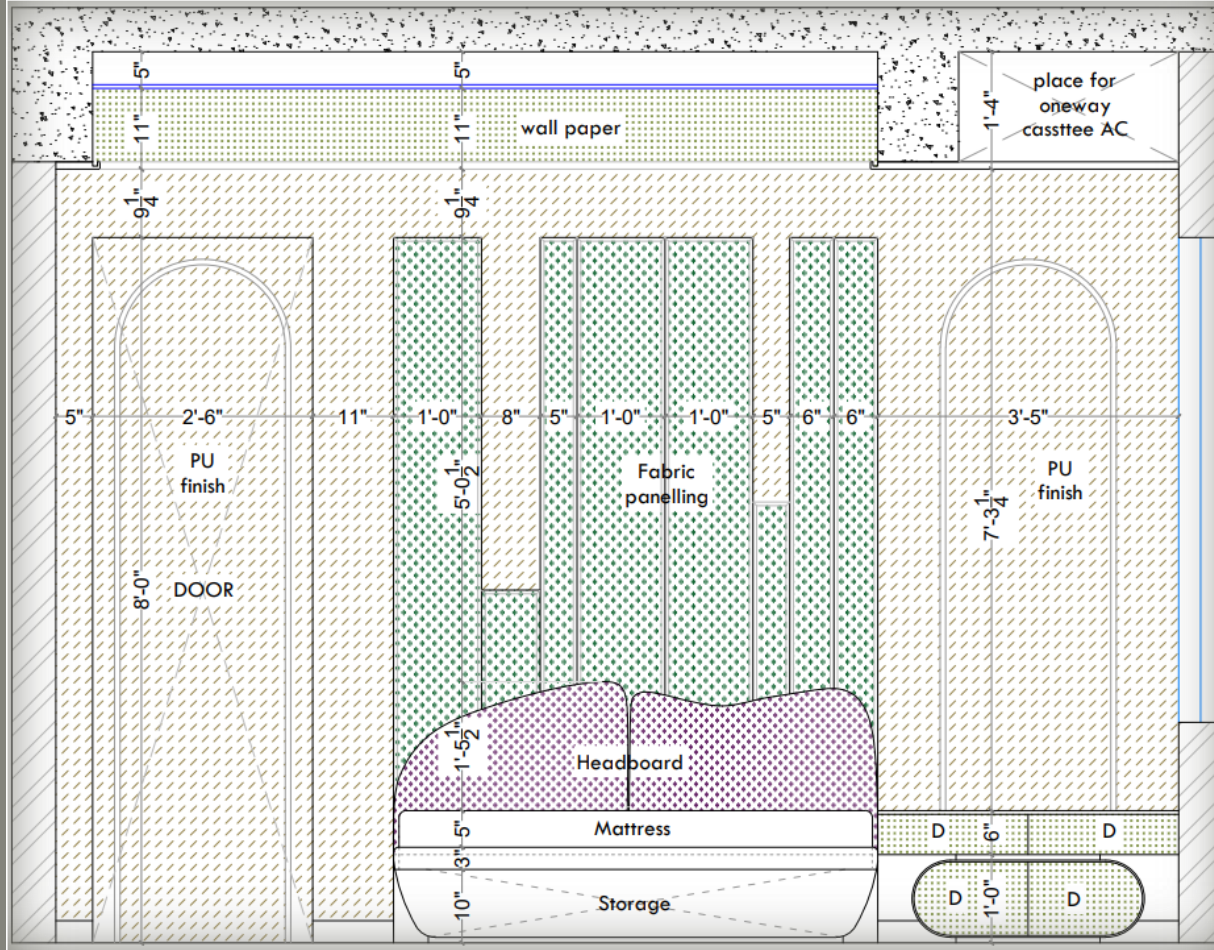

GIRLS BEDROOM



GIRLS BEDROOM



GIRLS BEDROOM

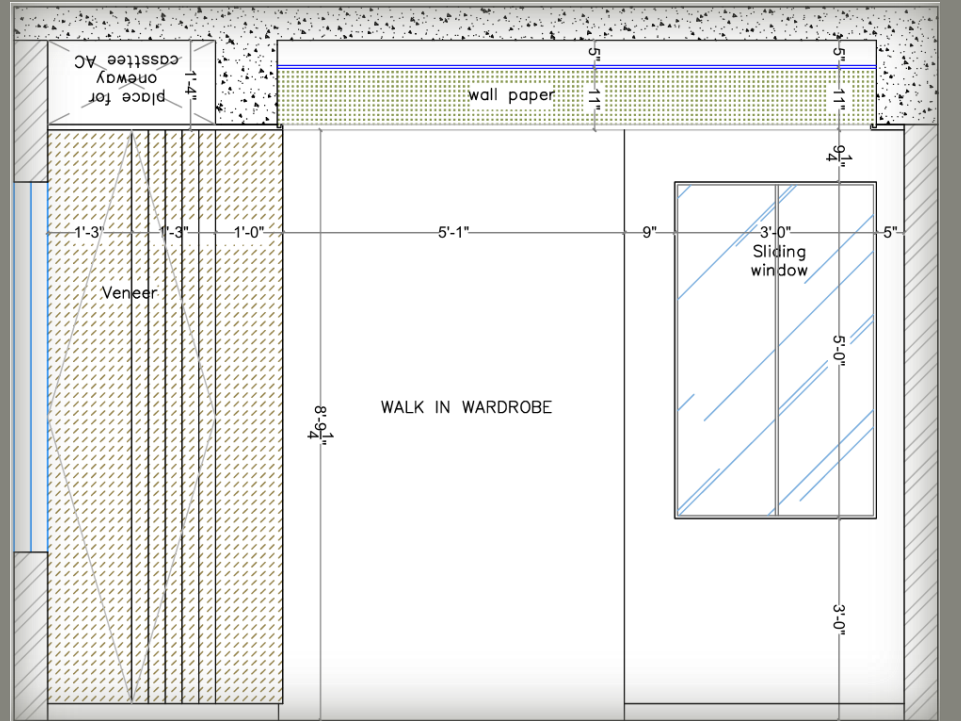
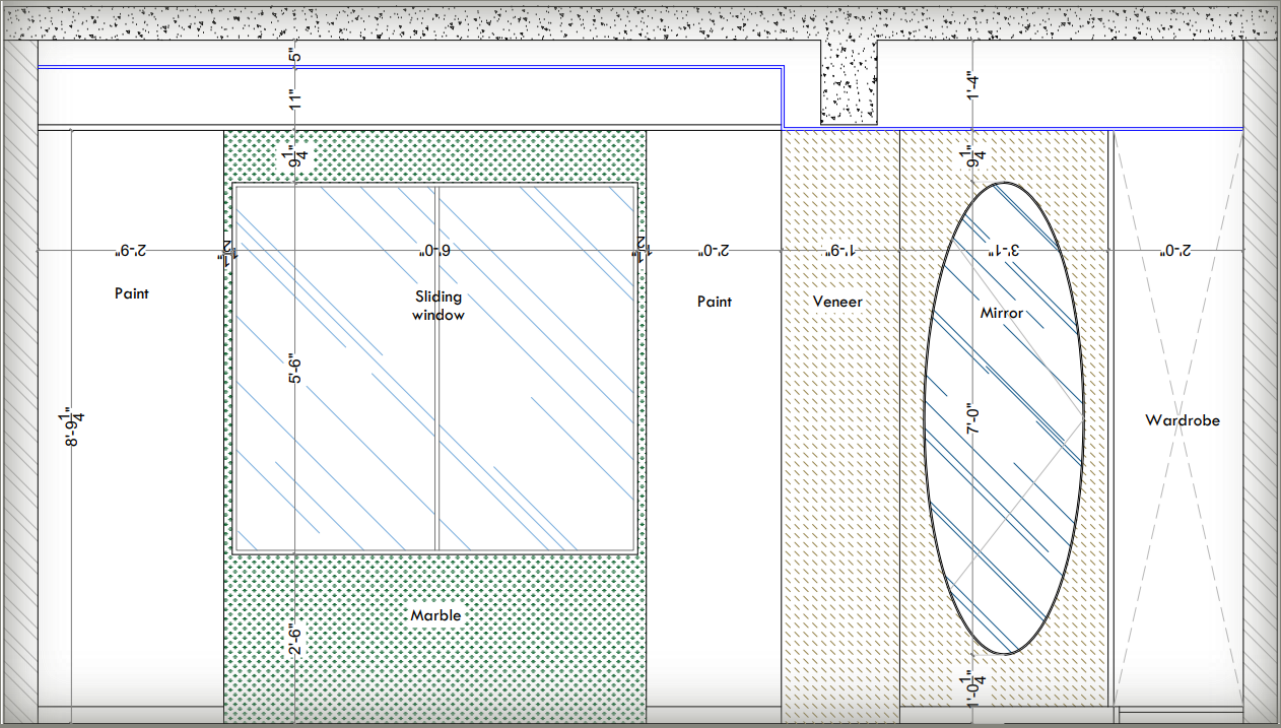

GIRLS BEDROOM



GIRLS BEDROOM



GIRLS BEDROOM

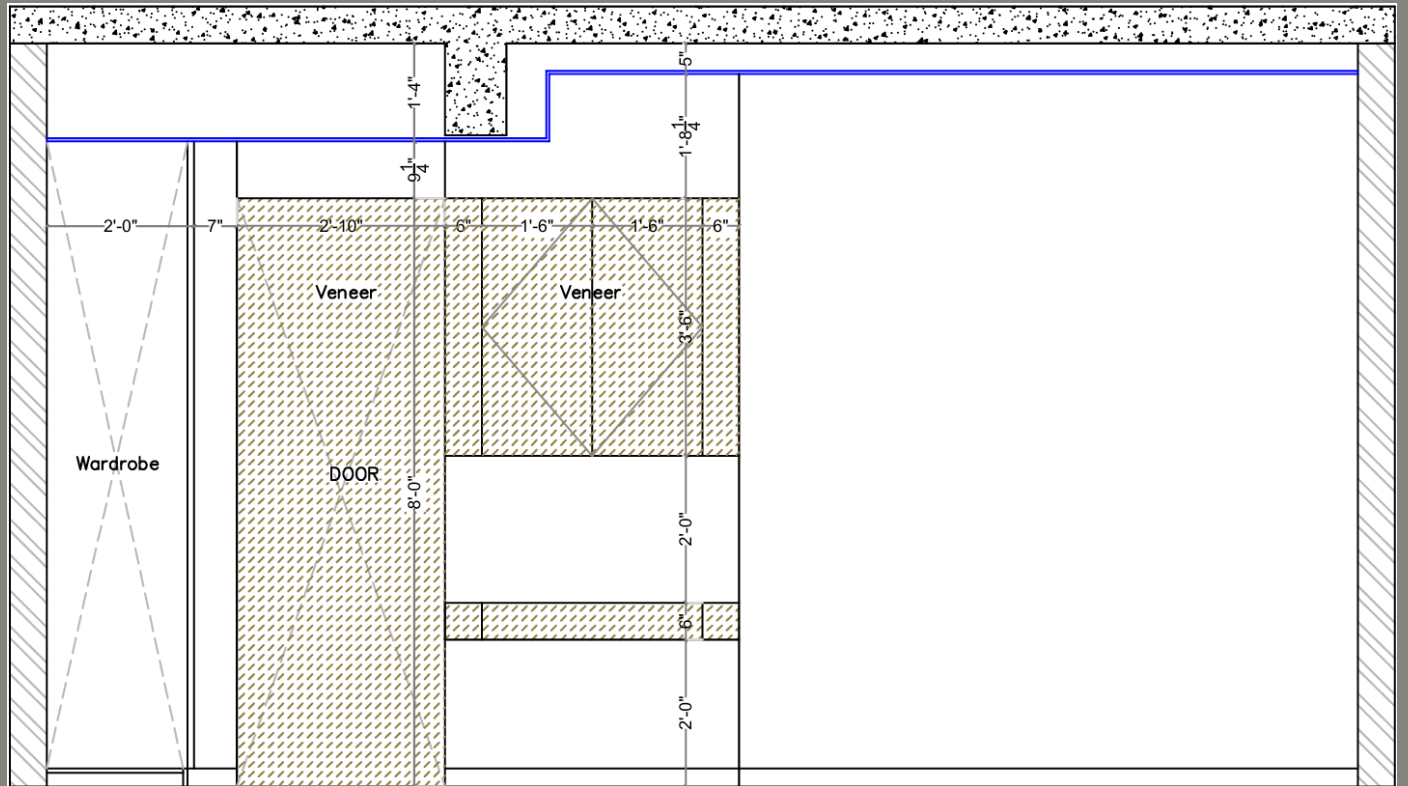

GIRLS BEDROOM



GIRLS BEDROOM

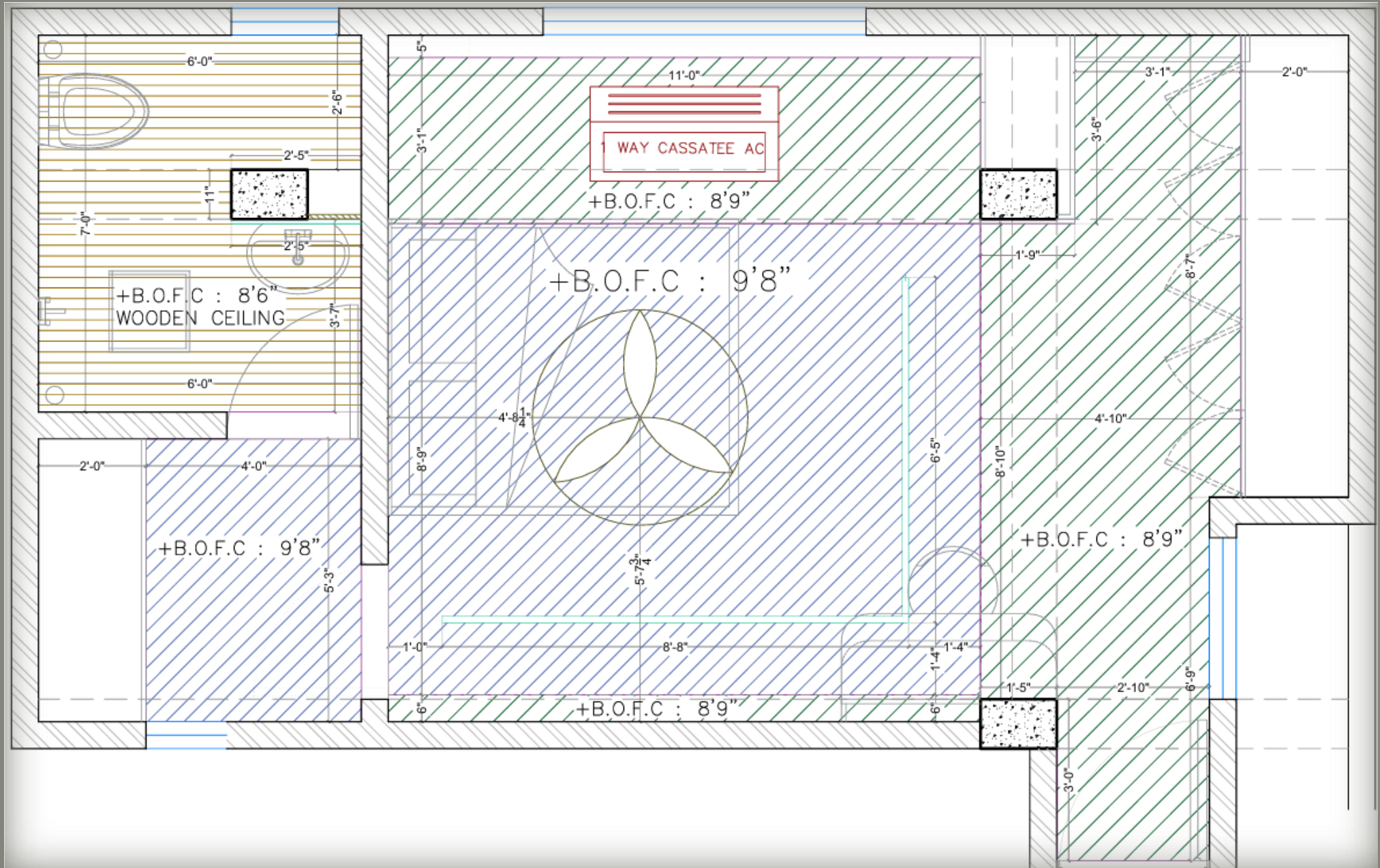

CEILING LAYOUT

GIRLS BEDROOM

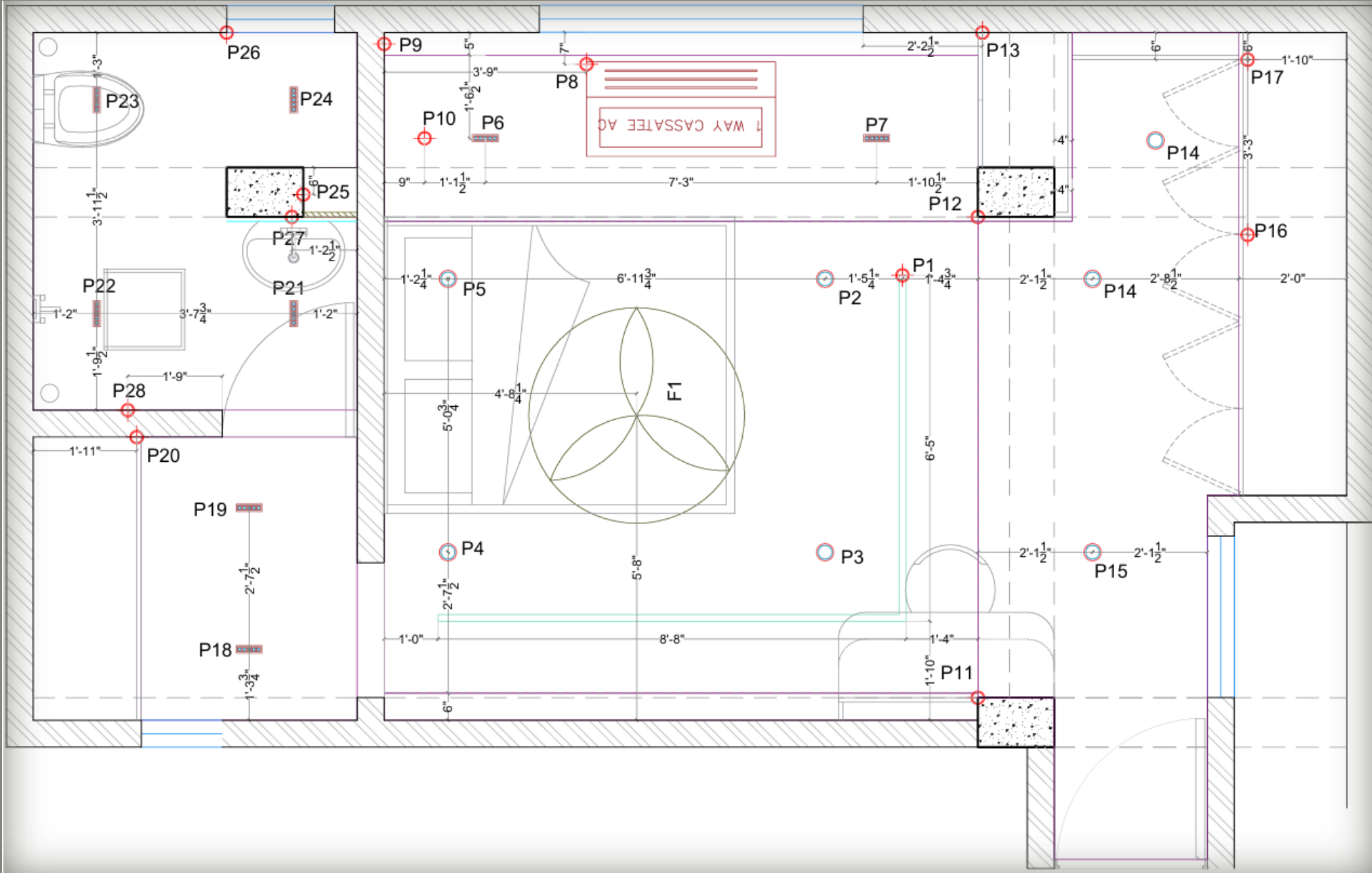

ELECTRICAL LAYOUT

GIRL'S BATHROOM

GIRL'S BATHROOM

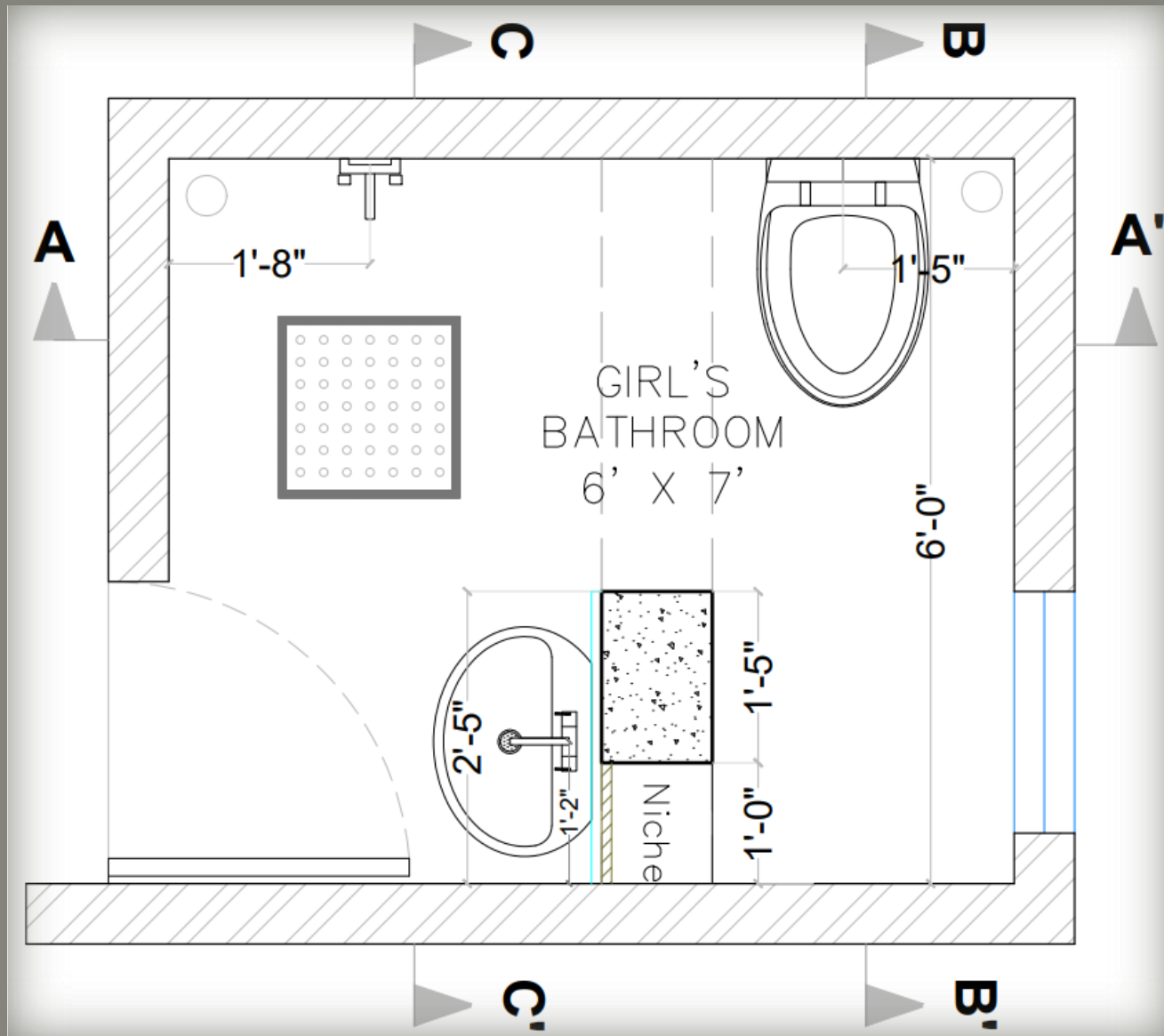

BATHROOM LAYOUT

GIRL'S BATHROOM

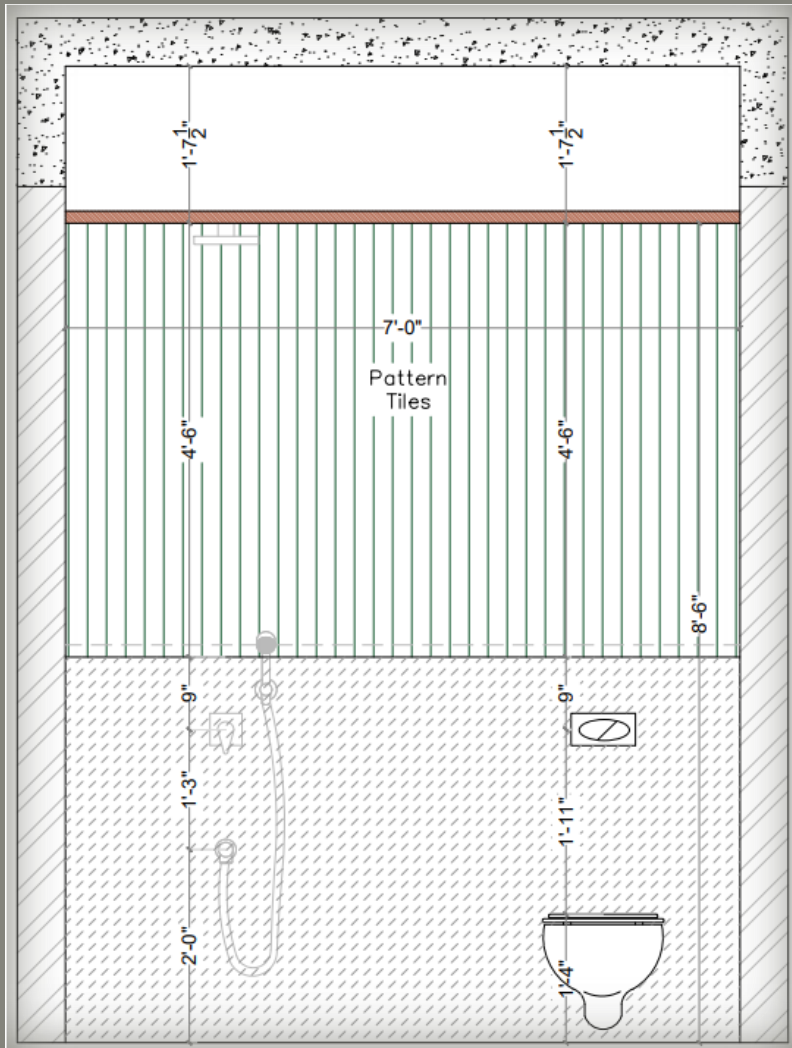

ELEVATION-AA'

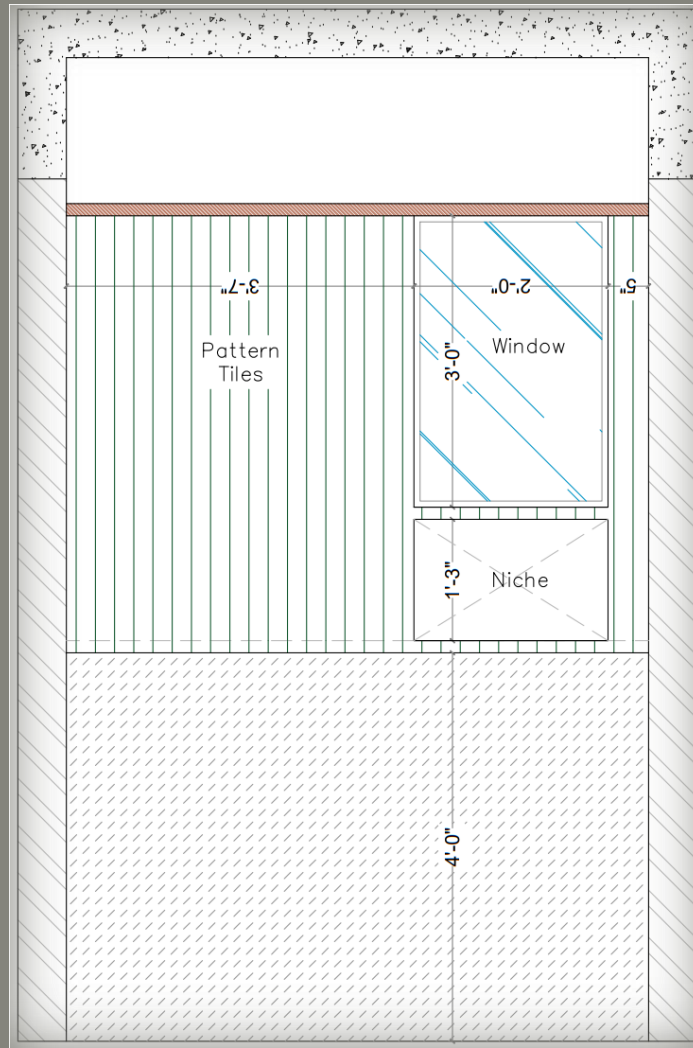

ELEVATION-BB'

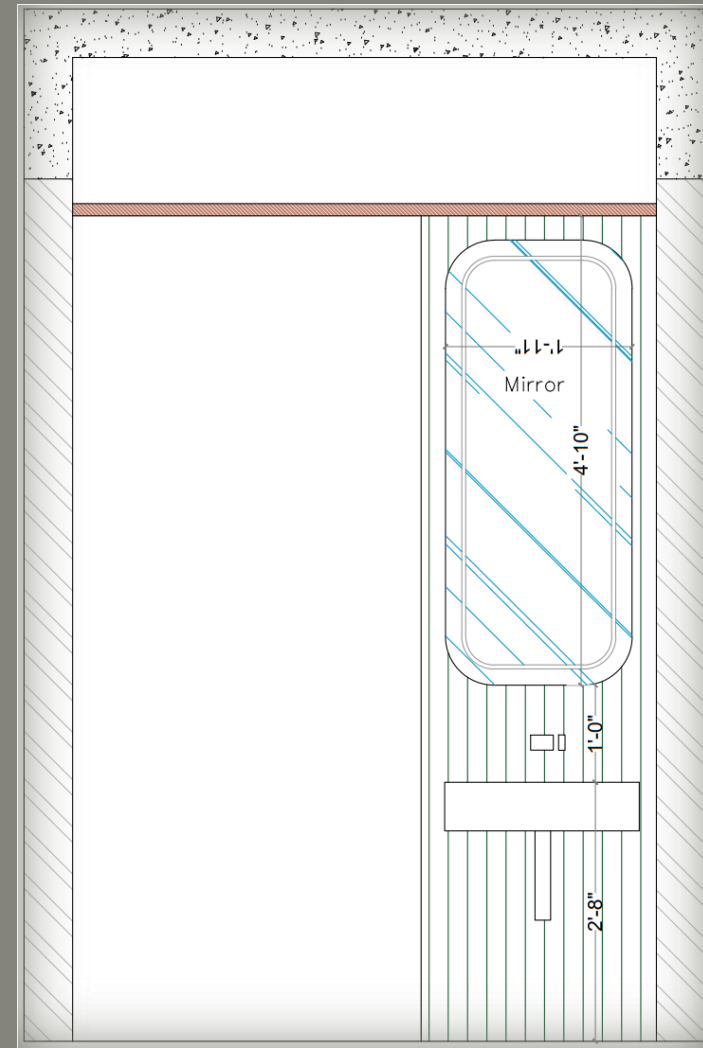

ELEVATION-CC'

GIRL'S BATHROOM



BOYS BEDROOM

BOYS BEDROOM

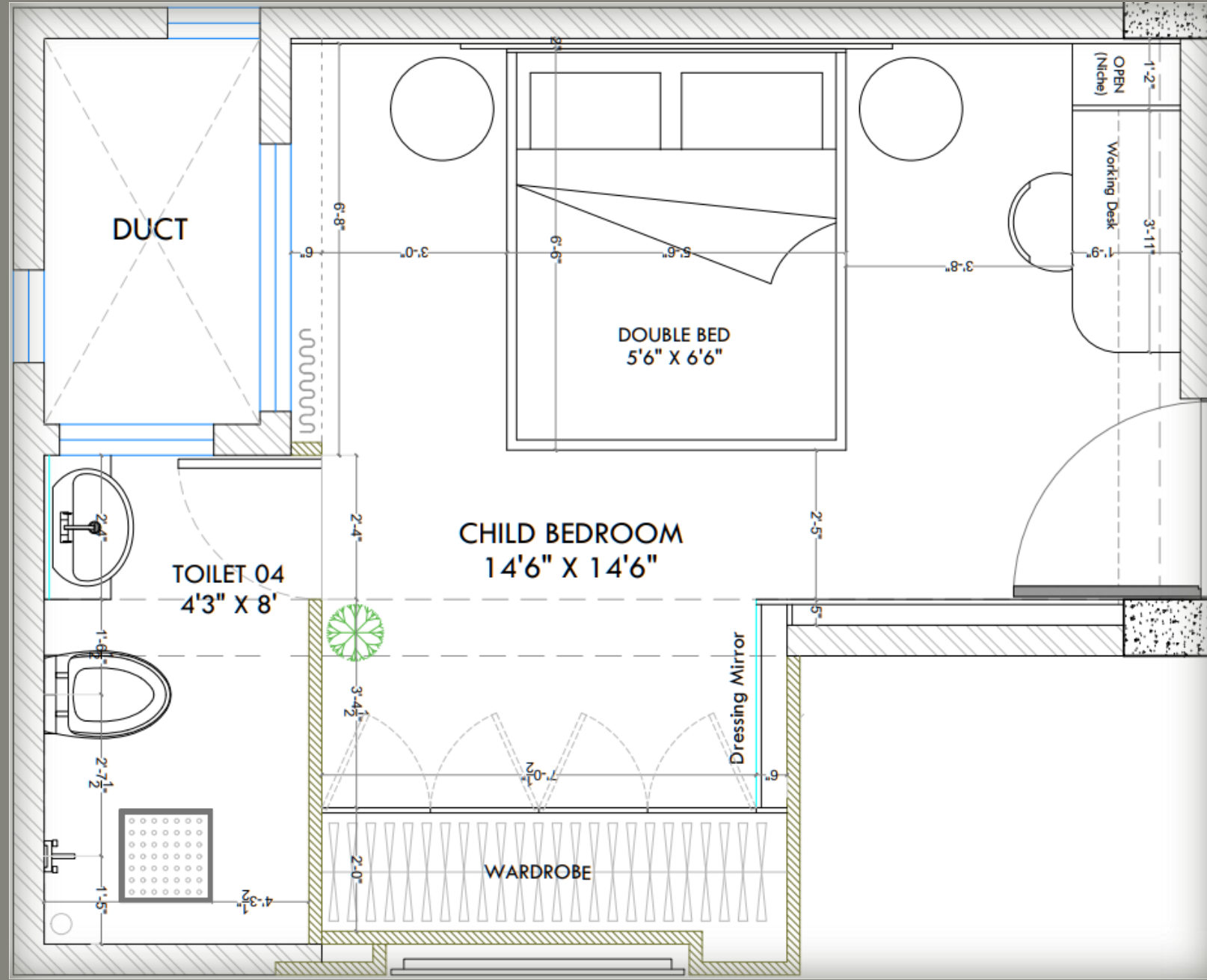

BOYS BEDROOM

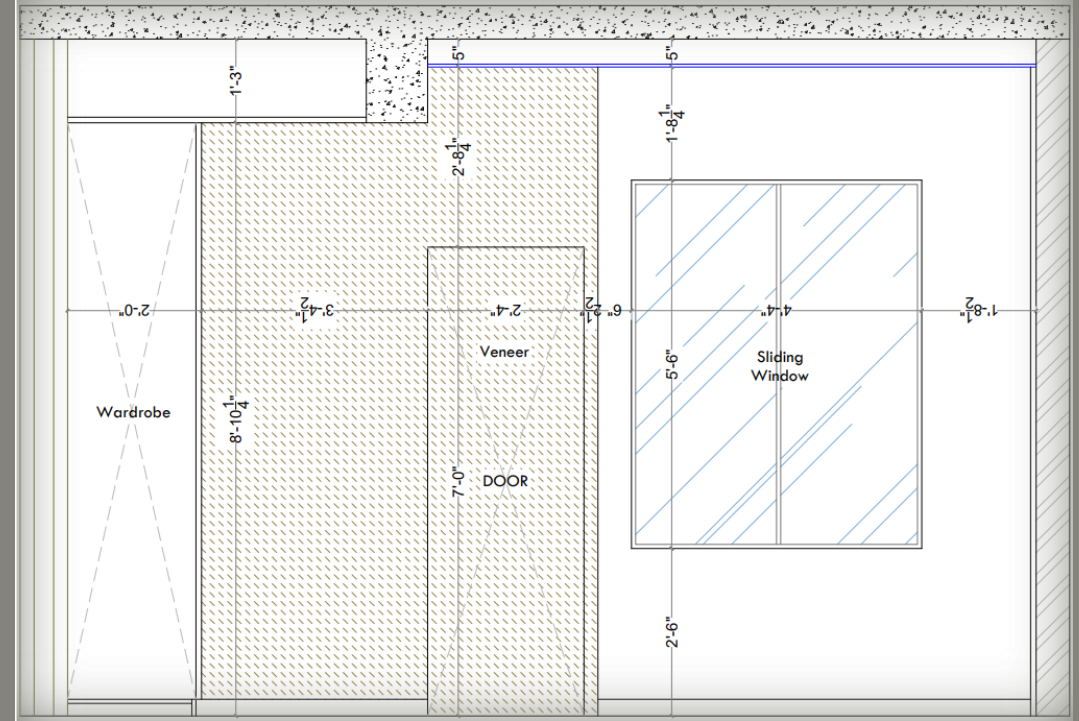
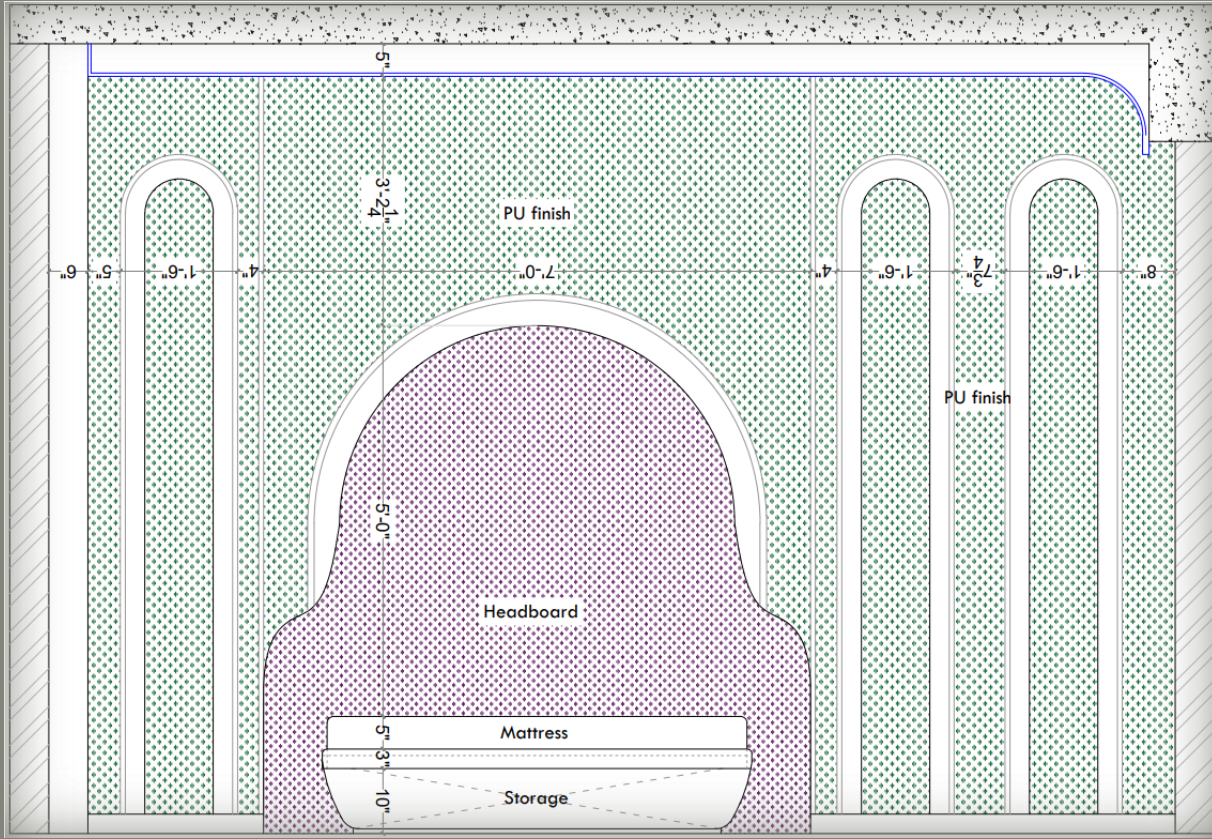

BOYS BEDROOM



BOYS BEDROOM



BOYS BEDROOM



BOYS BEDROOM

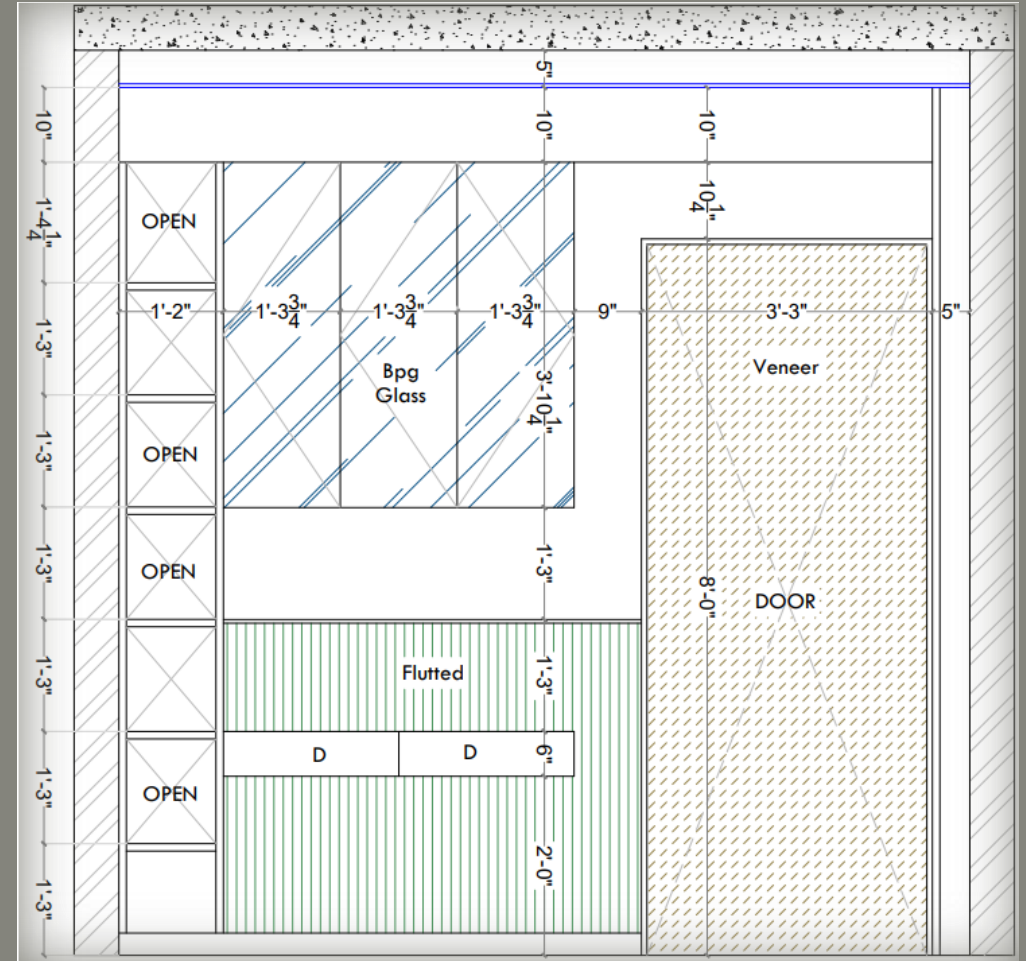
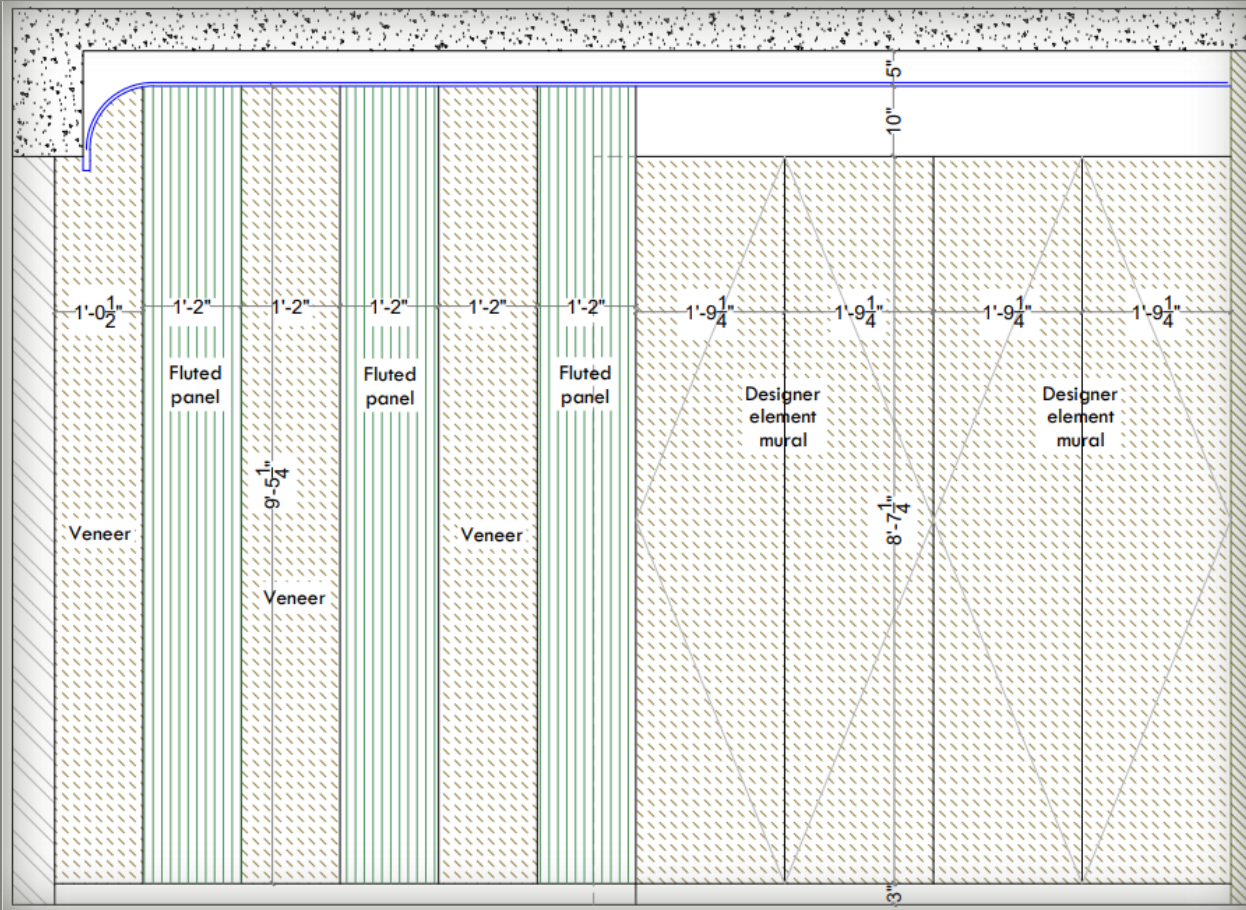

BOYS BEDROOM



BOYS BEDROOM



BOYS BEDROOM

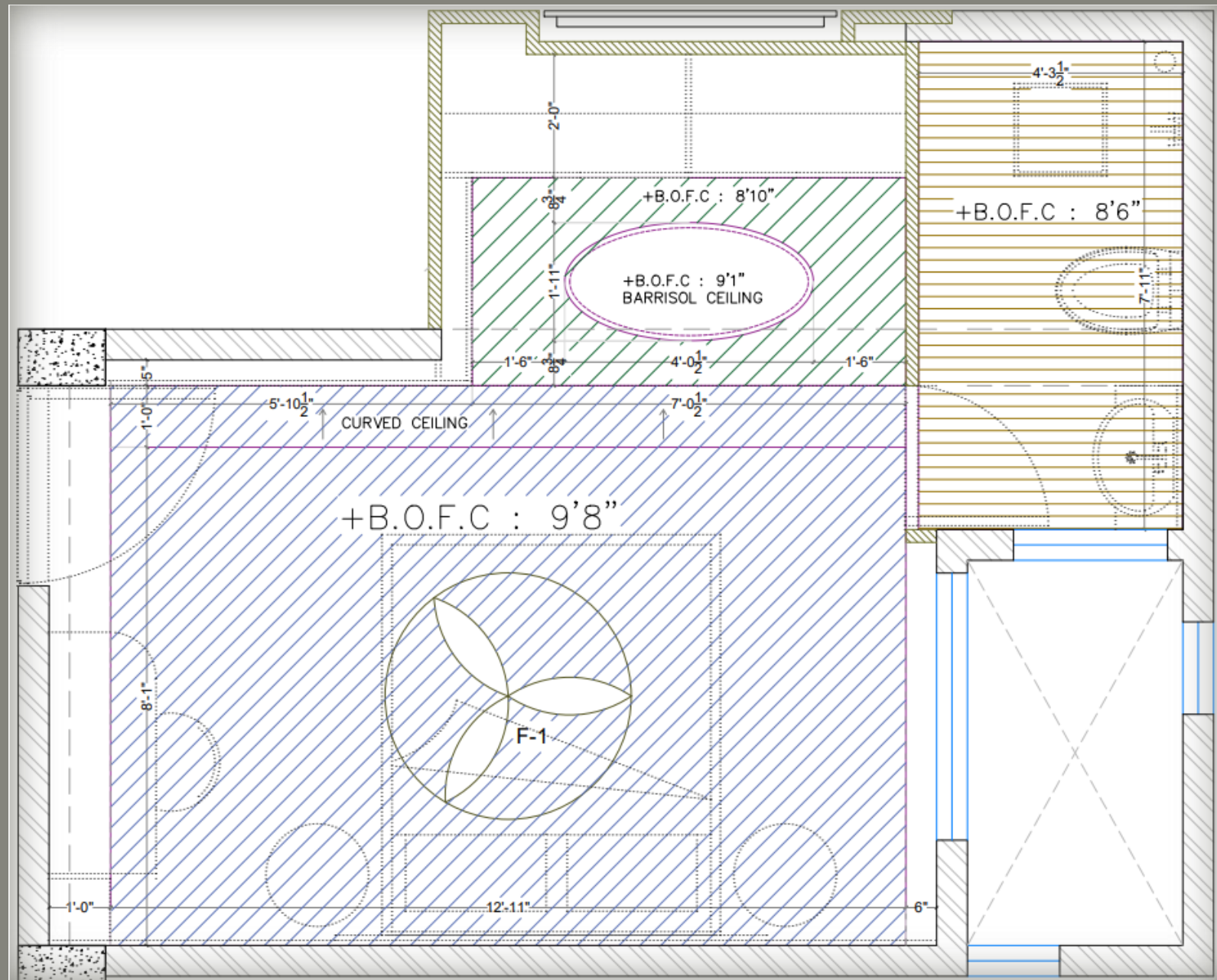

CEILING LAYOUT

BOYS BEDROOM

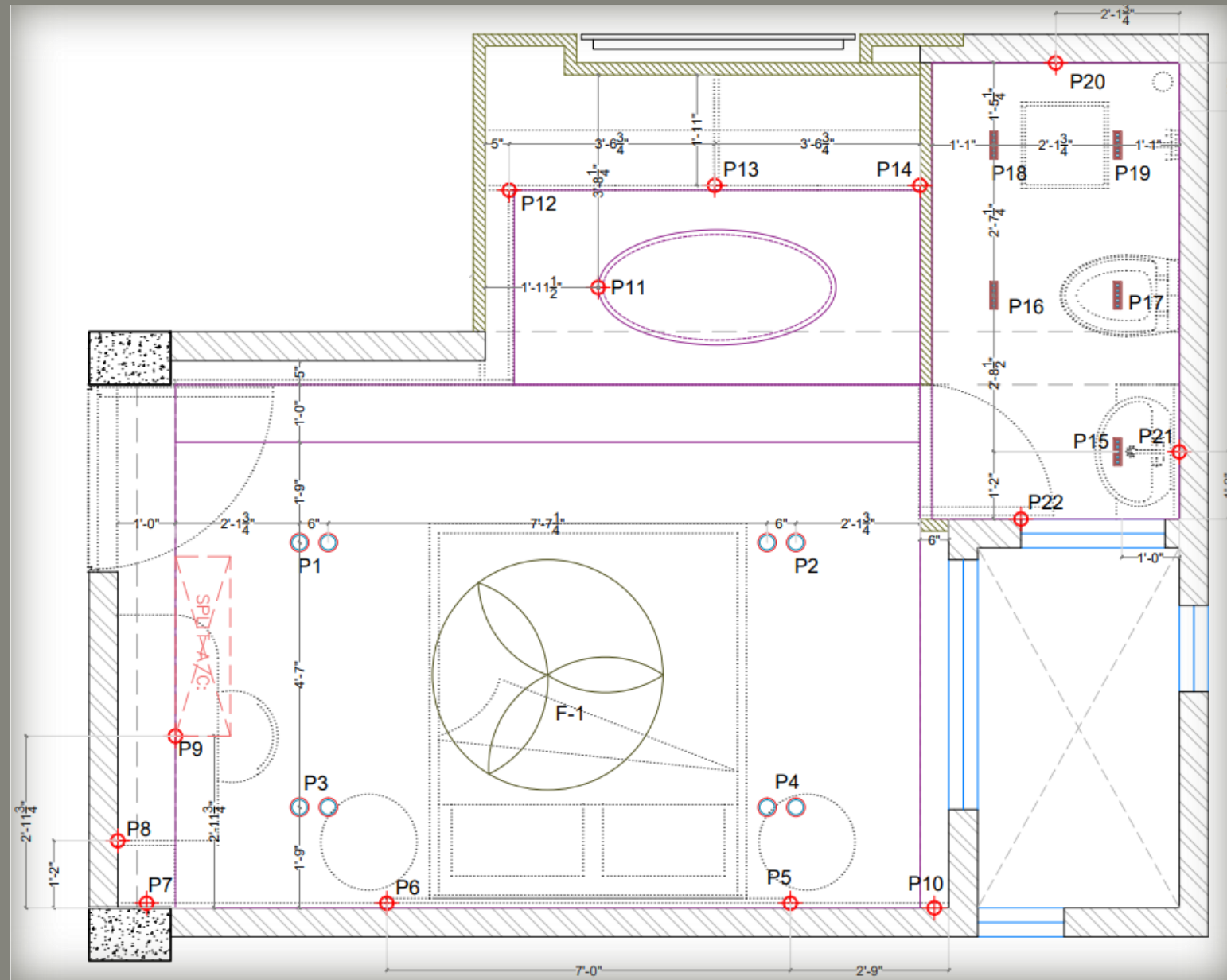

ELECTRICAL LAYOUT

BOYS BEDROOM

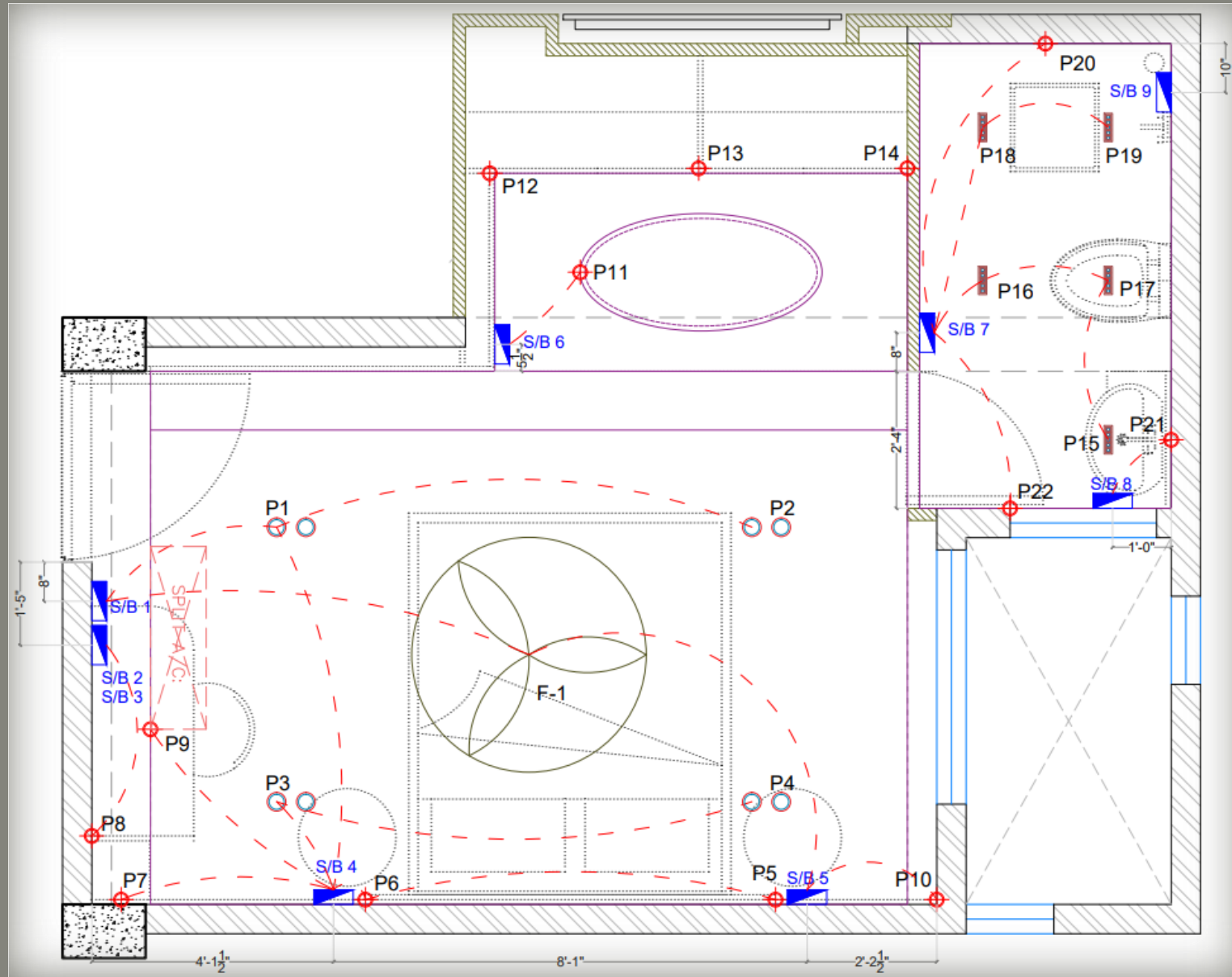

ELECTRICAL LOOPING LAYOUT

BOY'S BATHROOM

BOY'S BATHROOM

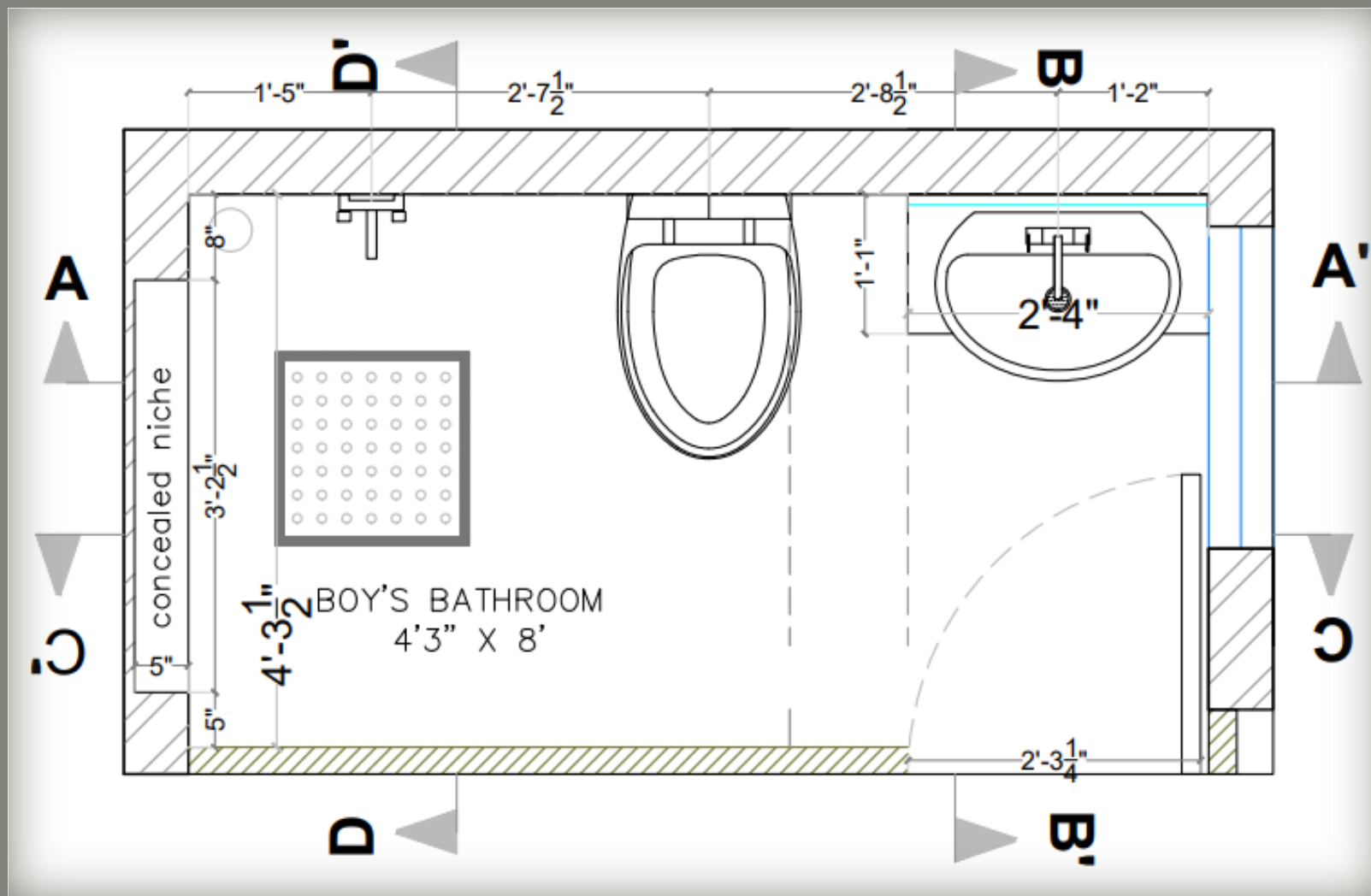

BATHROOM LAYOUT

BOY'S BATHROOM

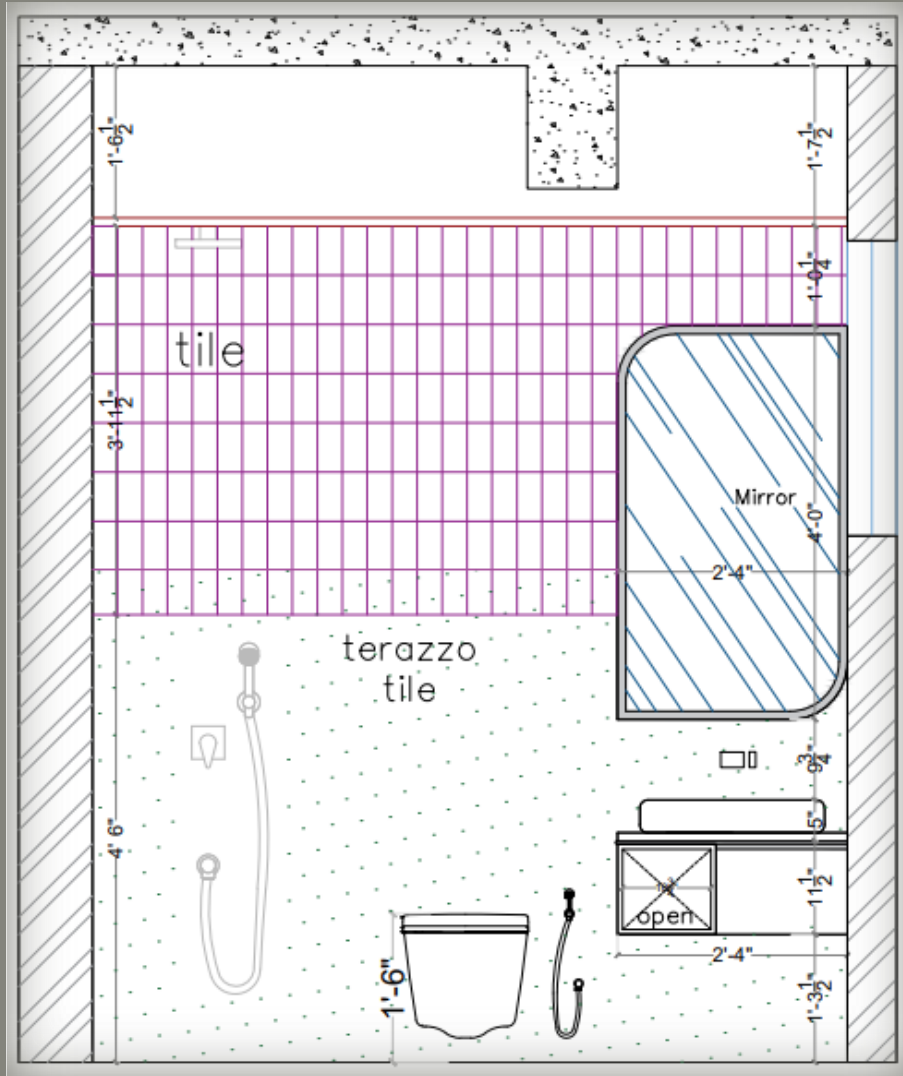

ELEVATION-AA'

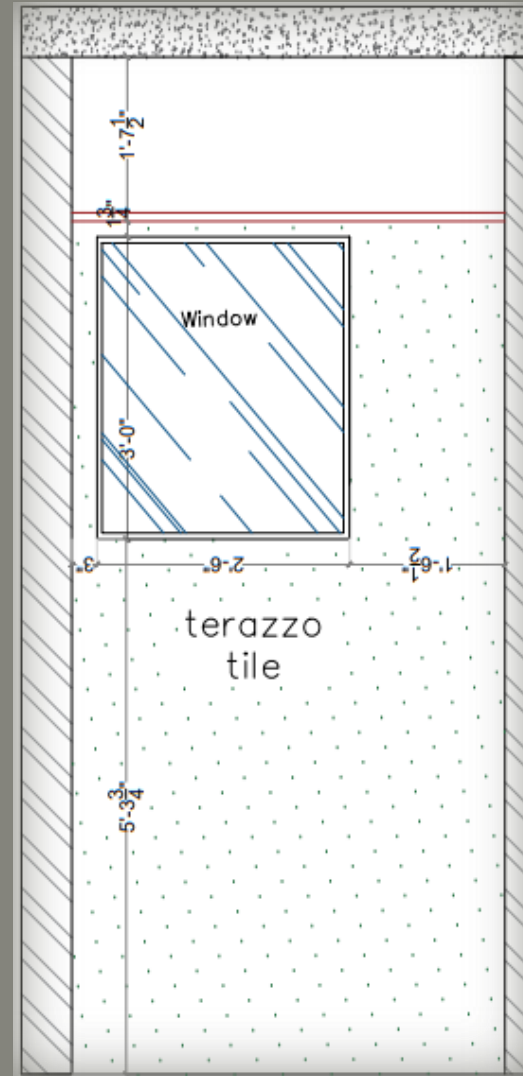

ELEVATION-BB'

BOY'S BATHROOM

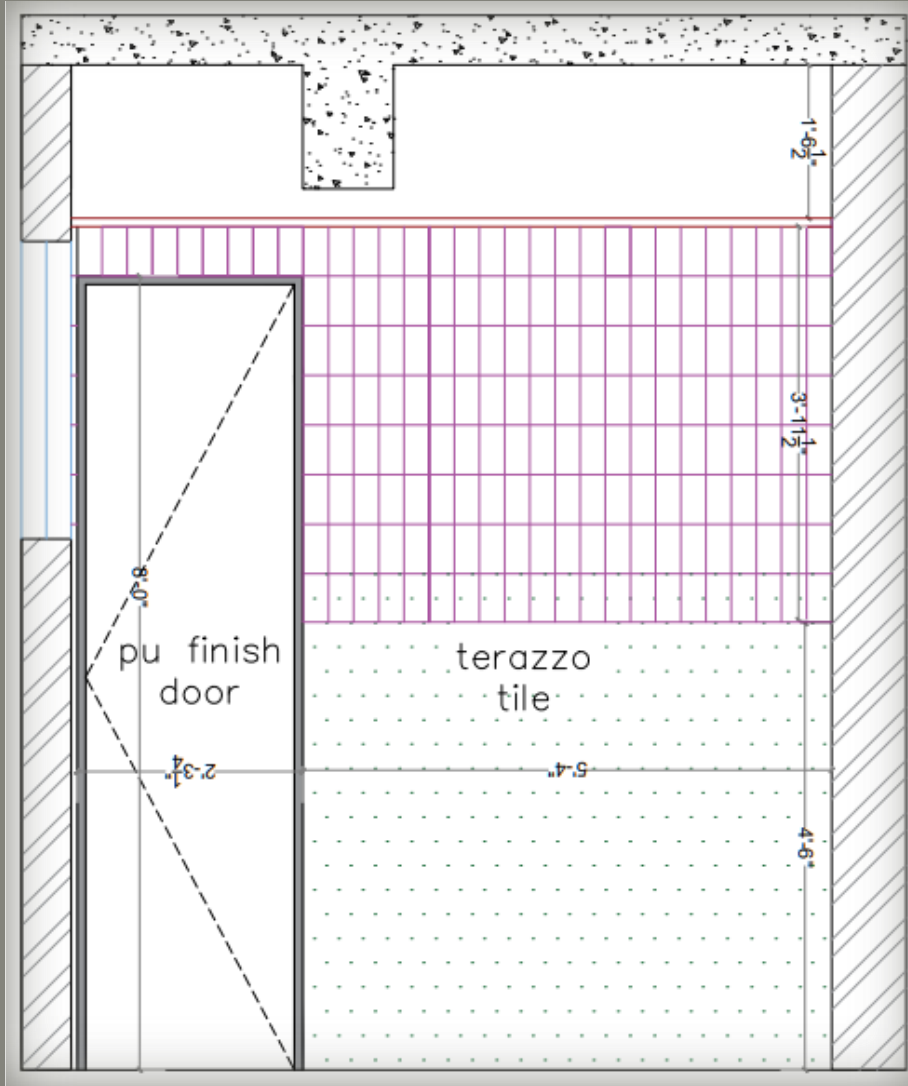

ELEVATION-AA'

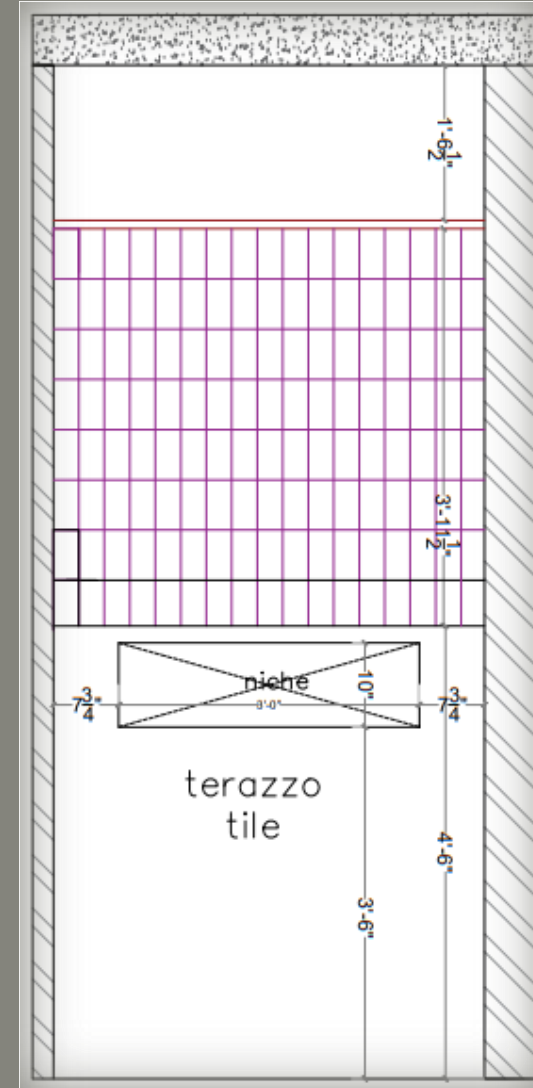

ELEVATION-BB'

MASTER BATHROOM-2



THANK YOU