

GROOVE
DESIGNS

INTERIOR PRESENTATION

MR. NEMICHAND JAIN,
MUMBAI

FLOOR PLAN

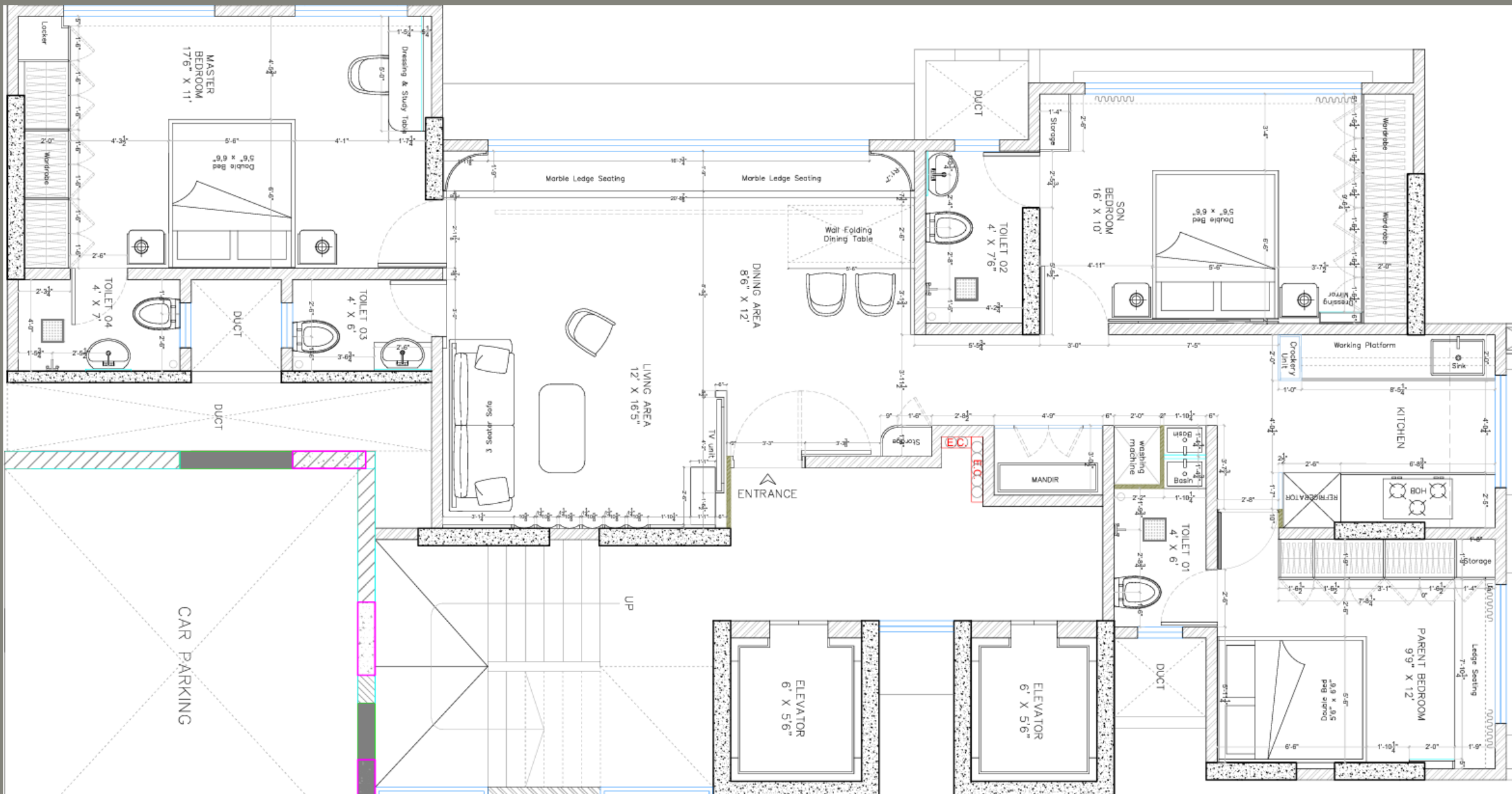

PLAN

FLOOR PLAN

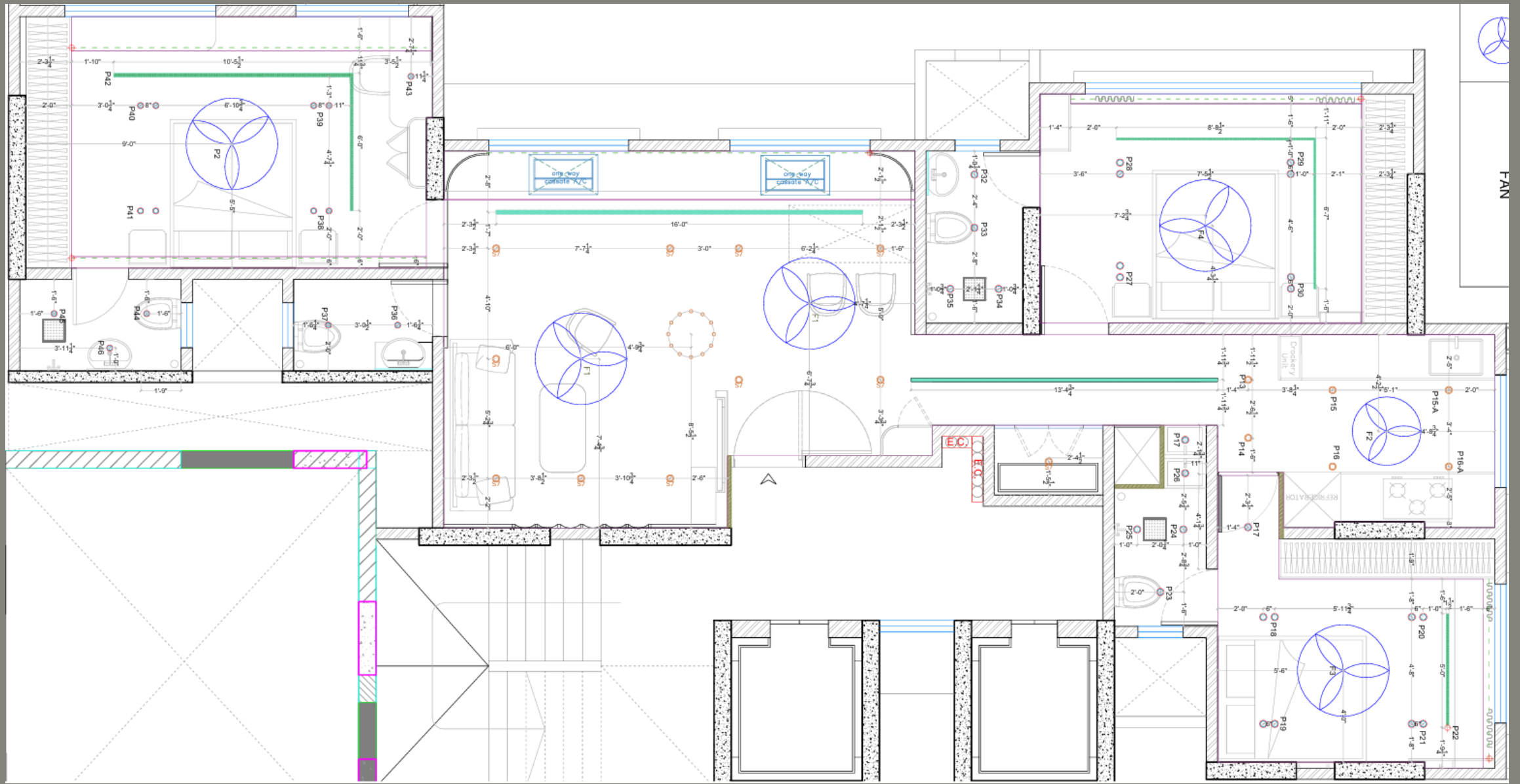

ELECTRICAL LAYOUT

LIVING ROOM

LIVING ROOM

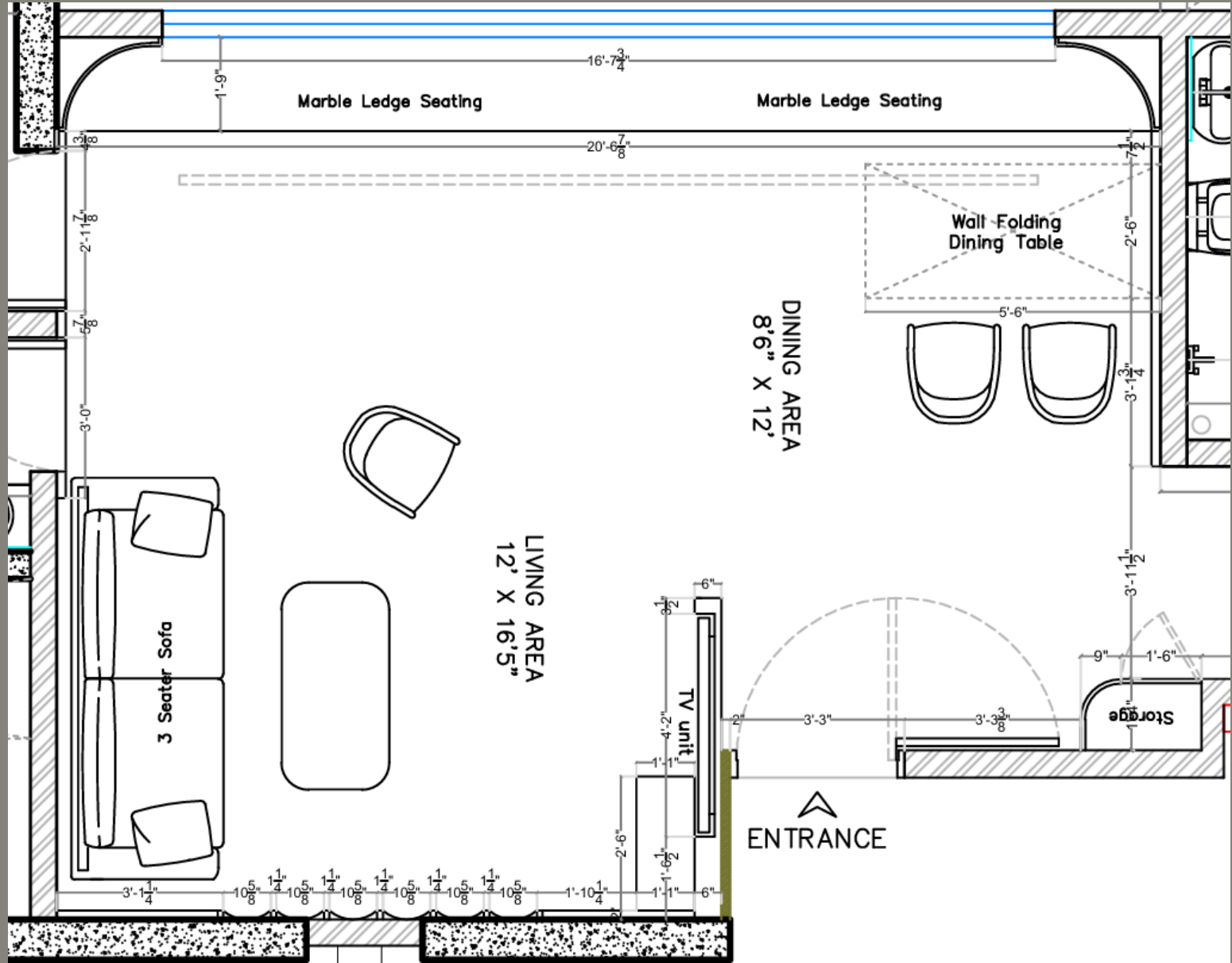

PLAN

LIVING ROOM

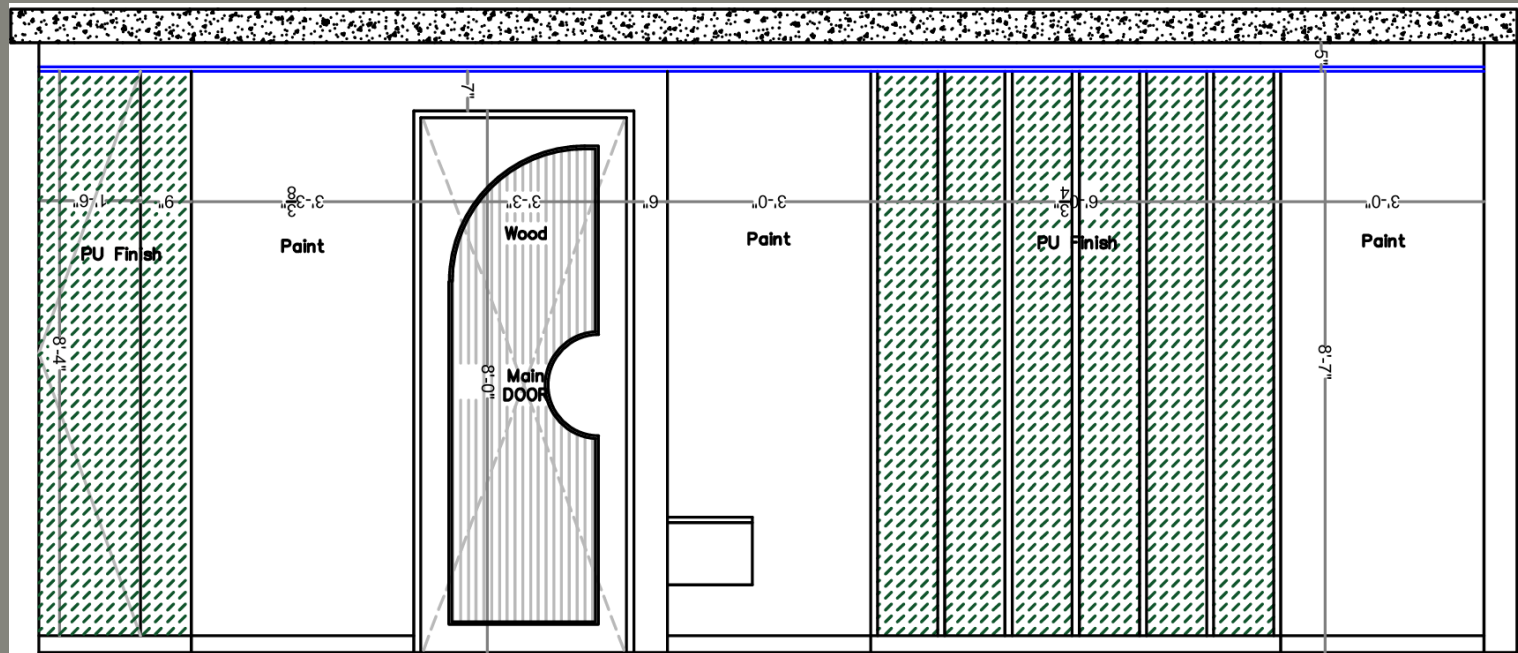
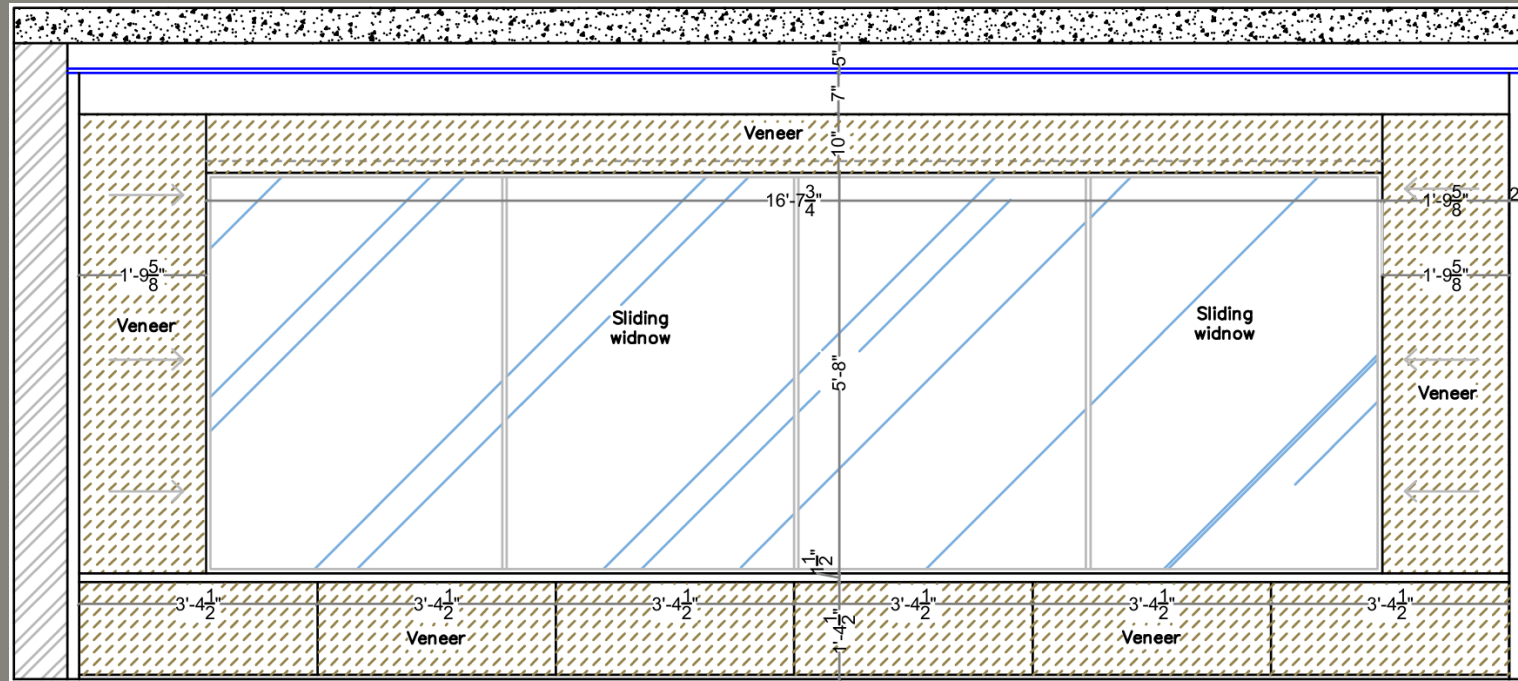

LIVING ROOM



LIVING ROOM



LIVING ROOM

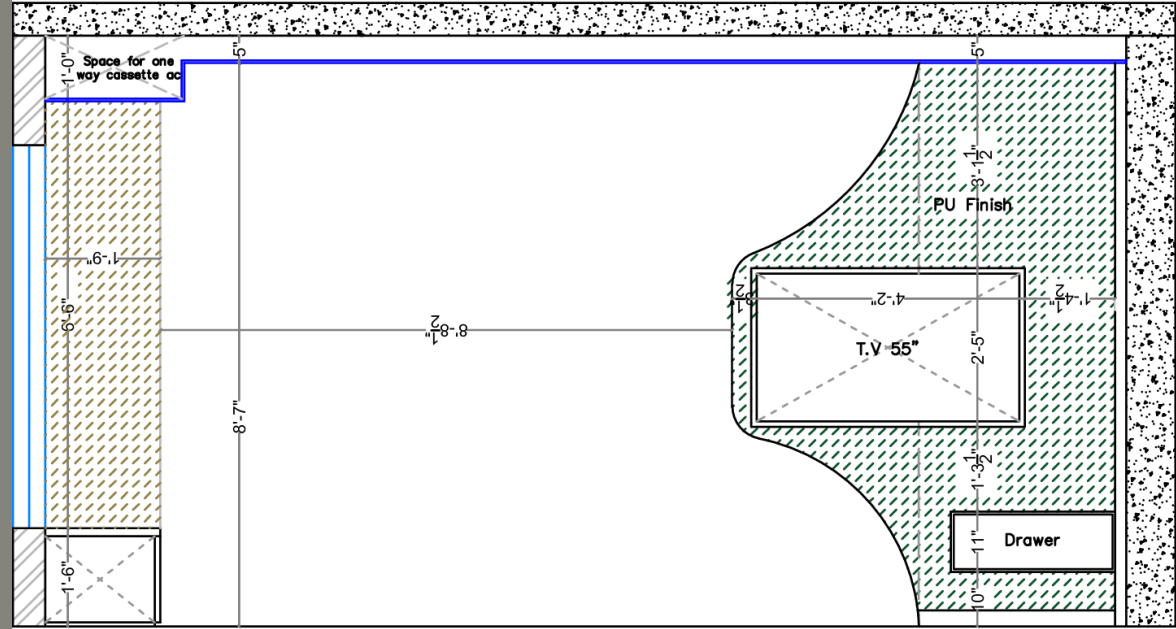
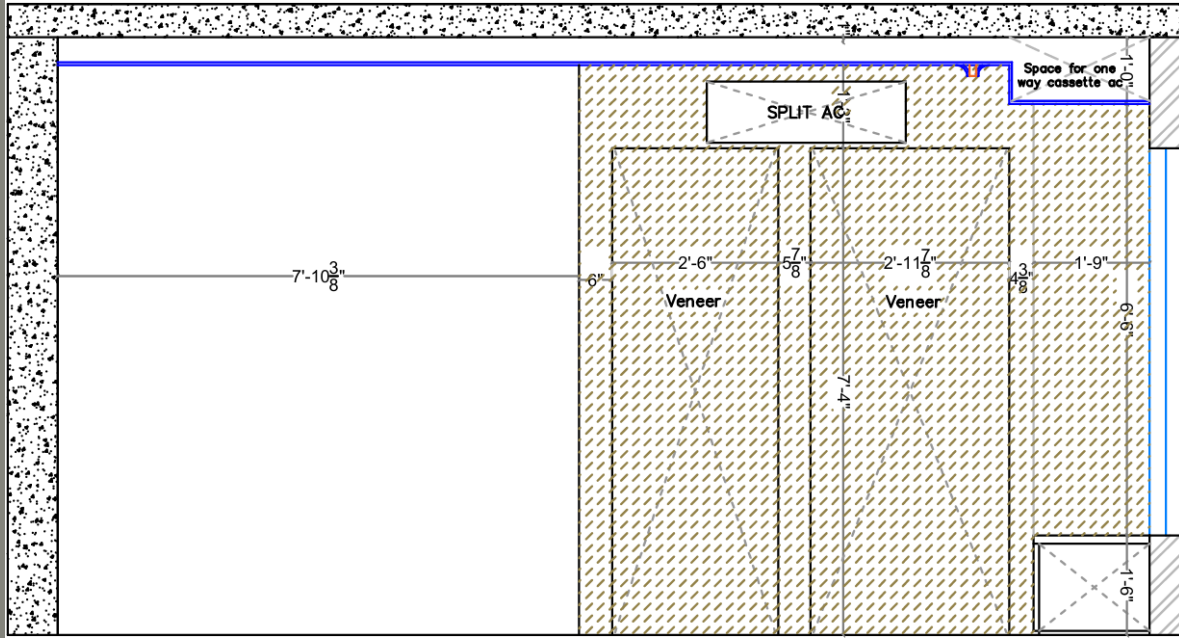

LIVING ROOM



LIVING ROOM



KITCHEN

KITCHEN

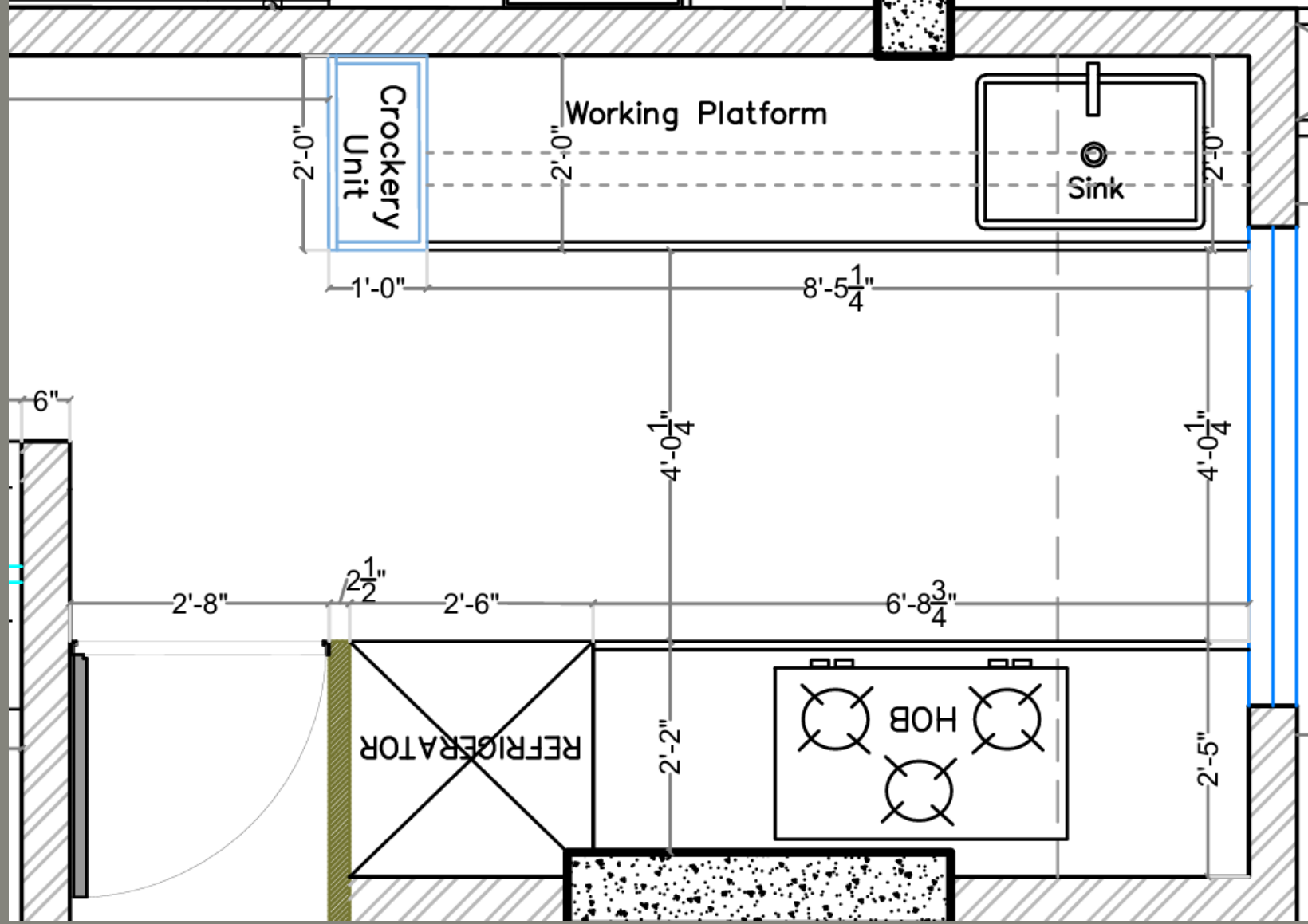

PLAN

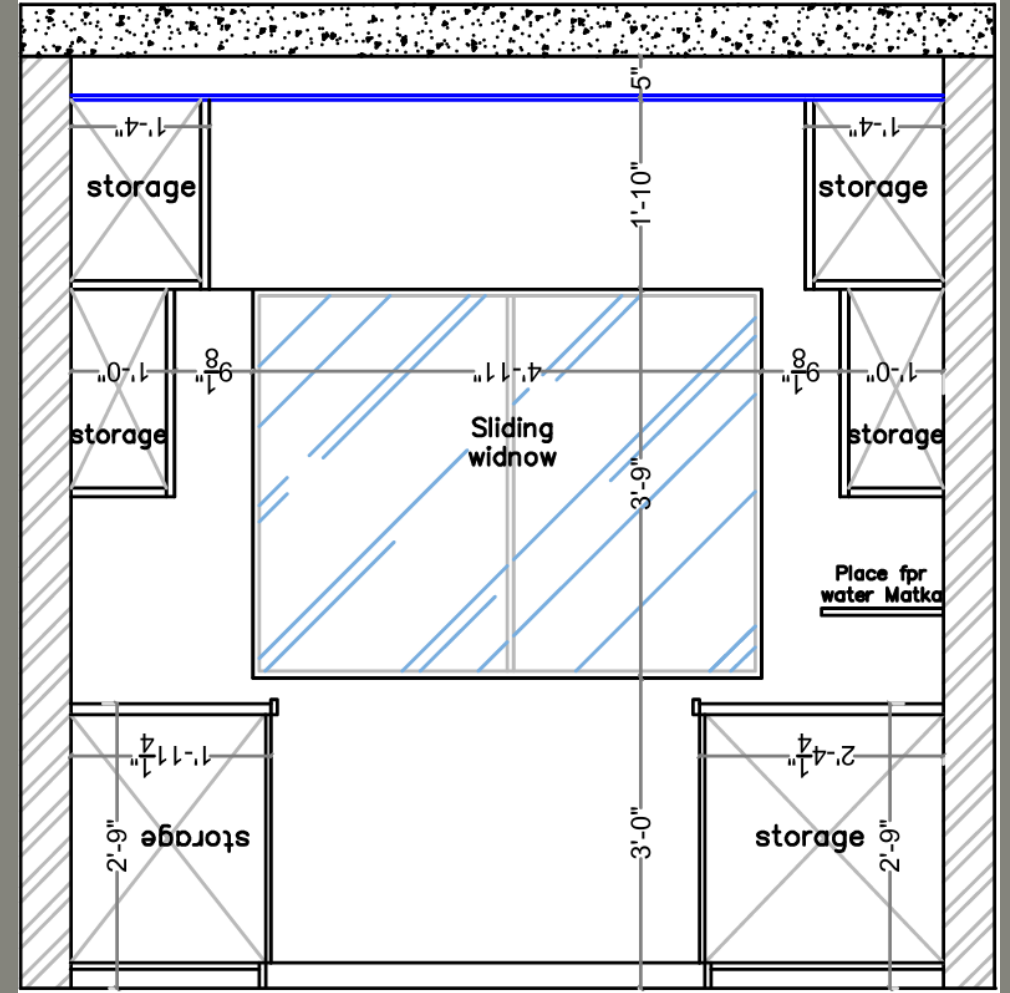
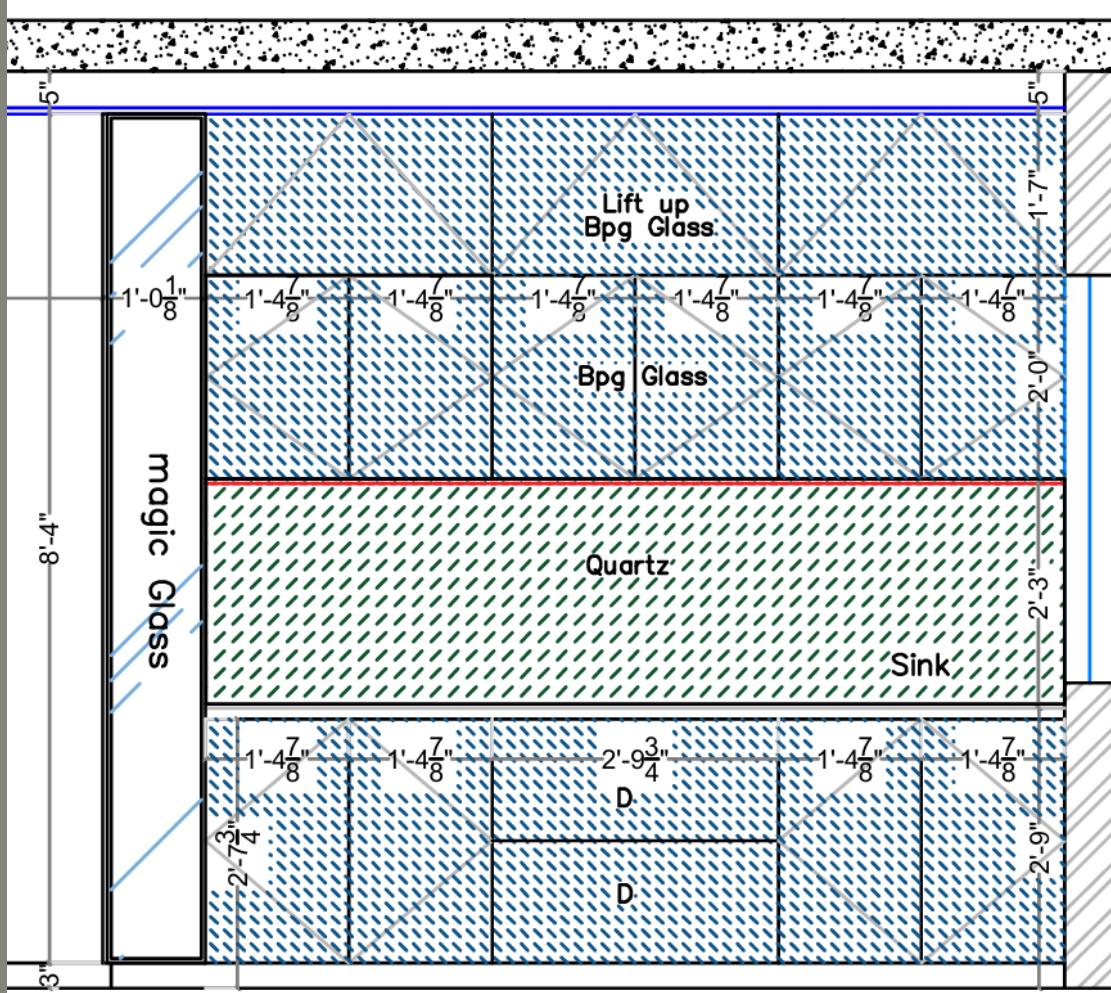

KITCHEN



KITCHEN



KITCHEN

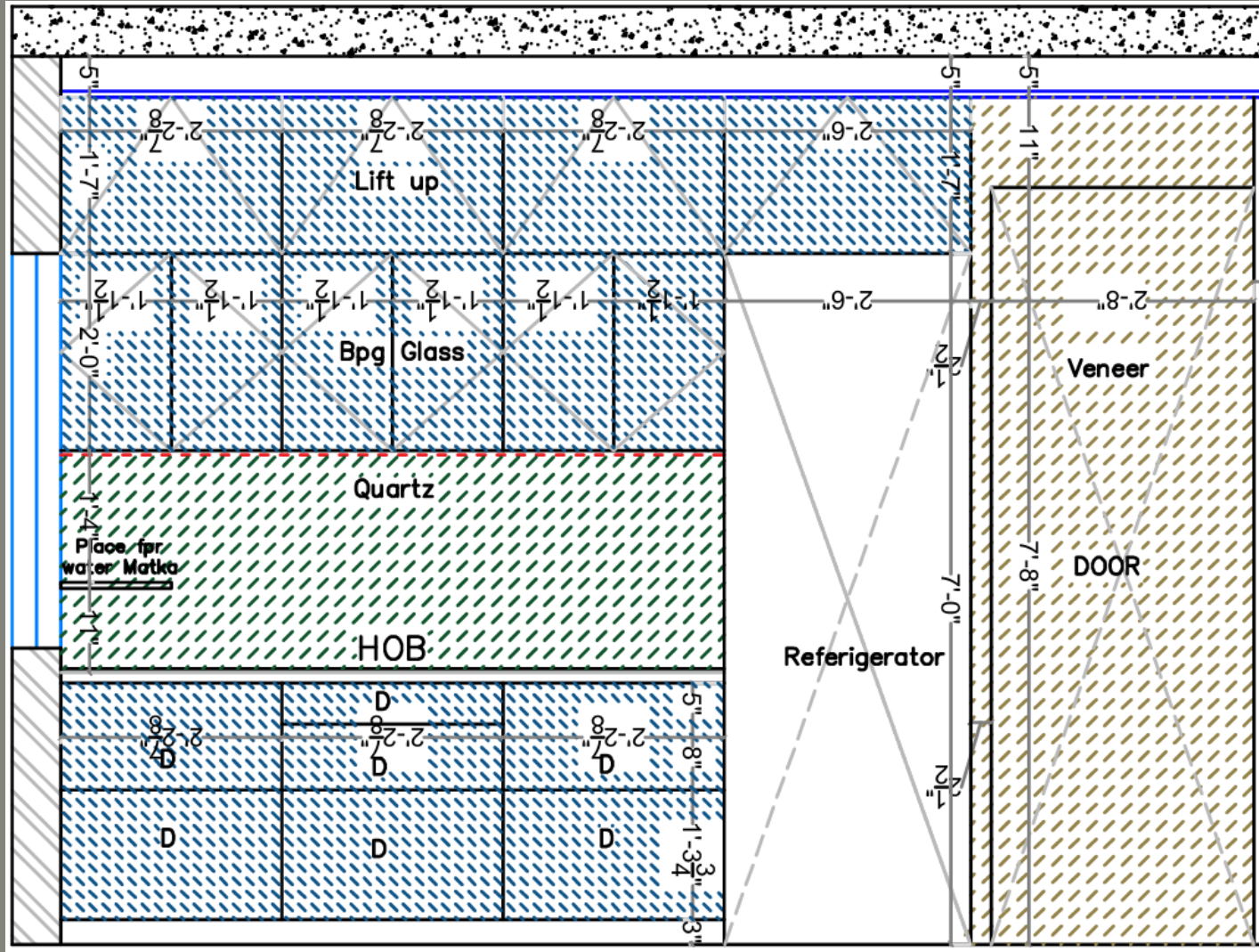

KITCHEN



MASTER BEDROOM

MASTER BEDROOM

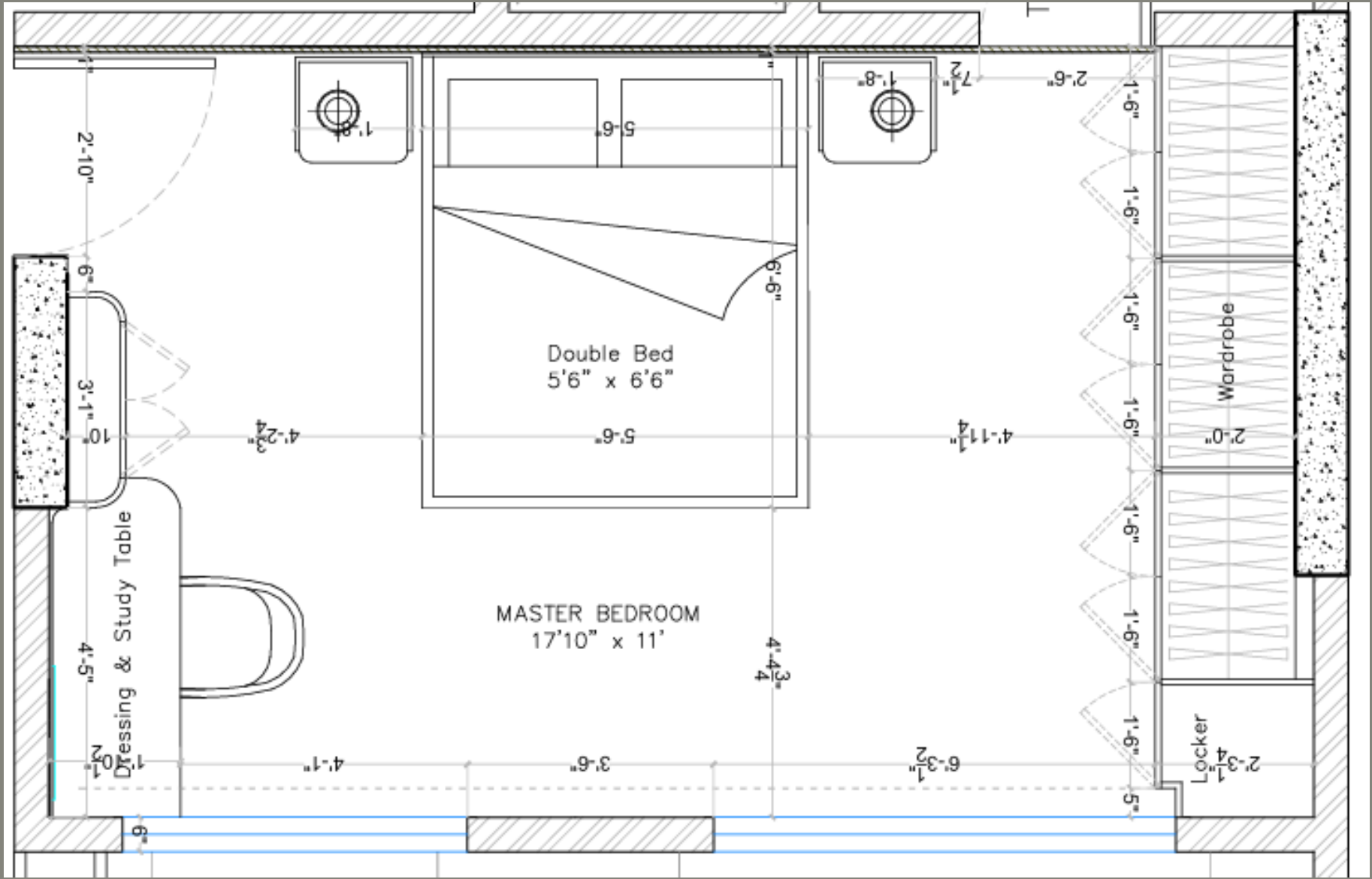

PLAN

MASTER BEDROOM



MASTER BEDROOM



MASTER BEDROOM

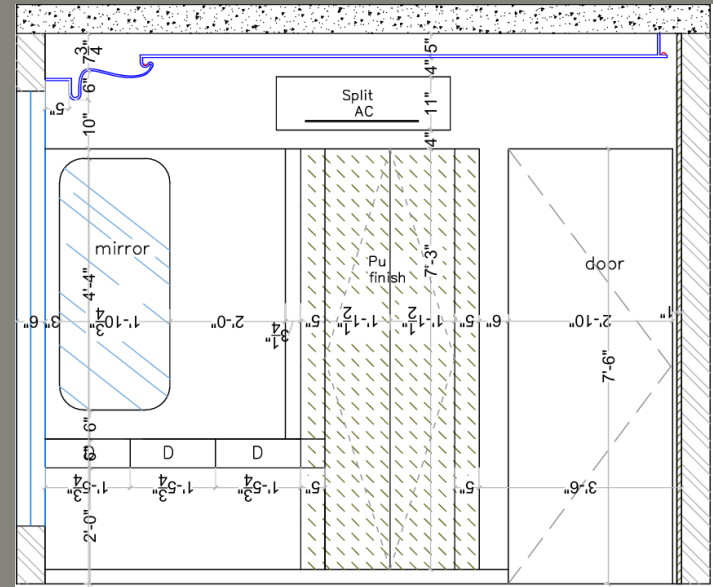
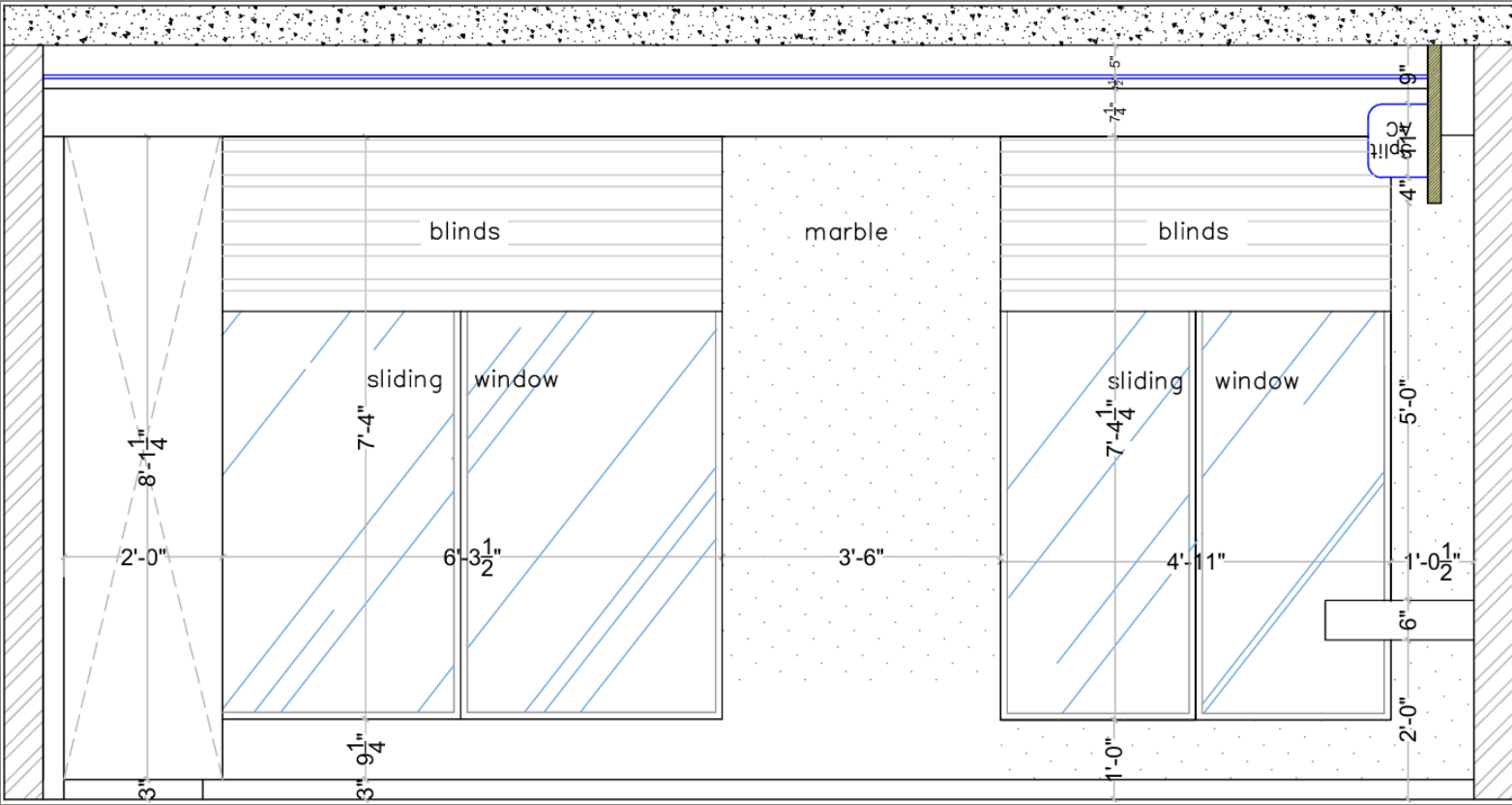

MASTER BEDROOM



MASTER BEDROOM



SON'S BEDROOM

SON'S BEDROOM

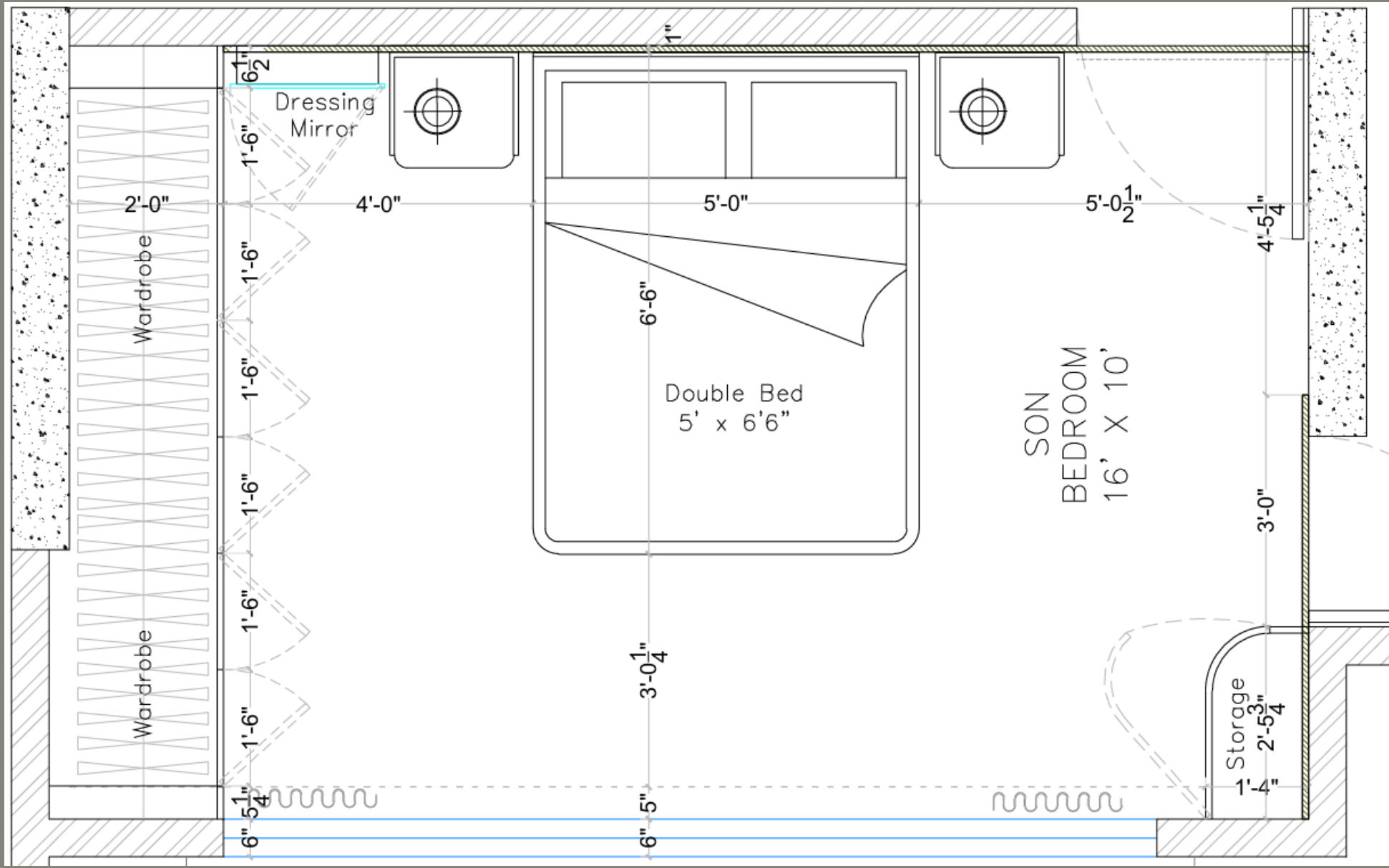

SON'S BEDROOM

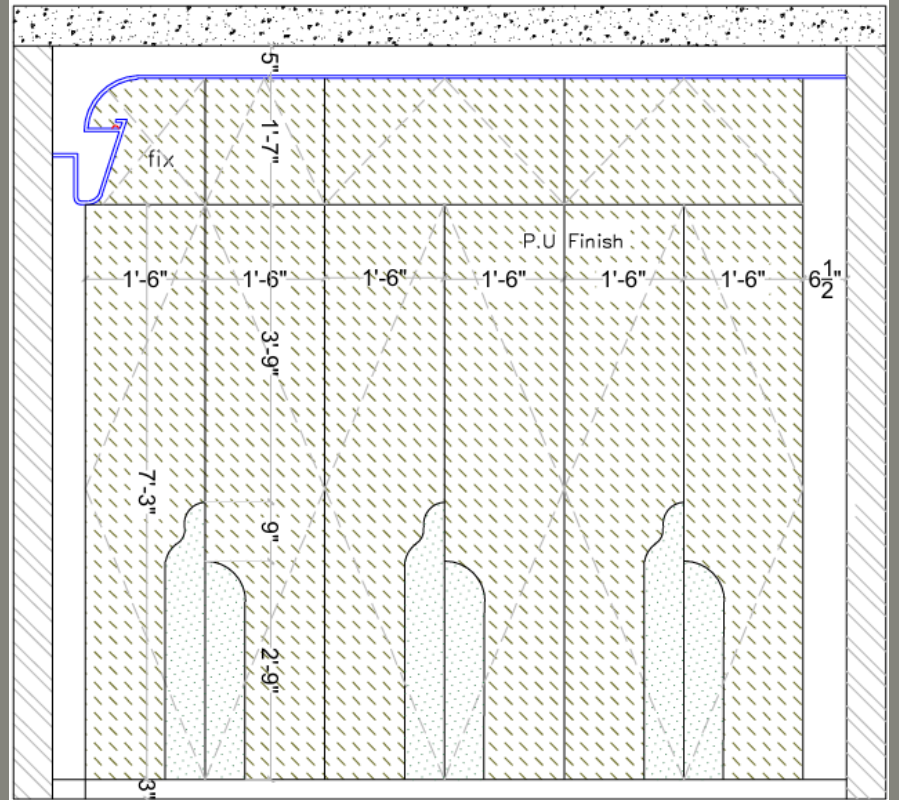
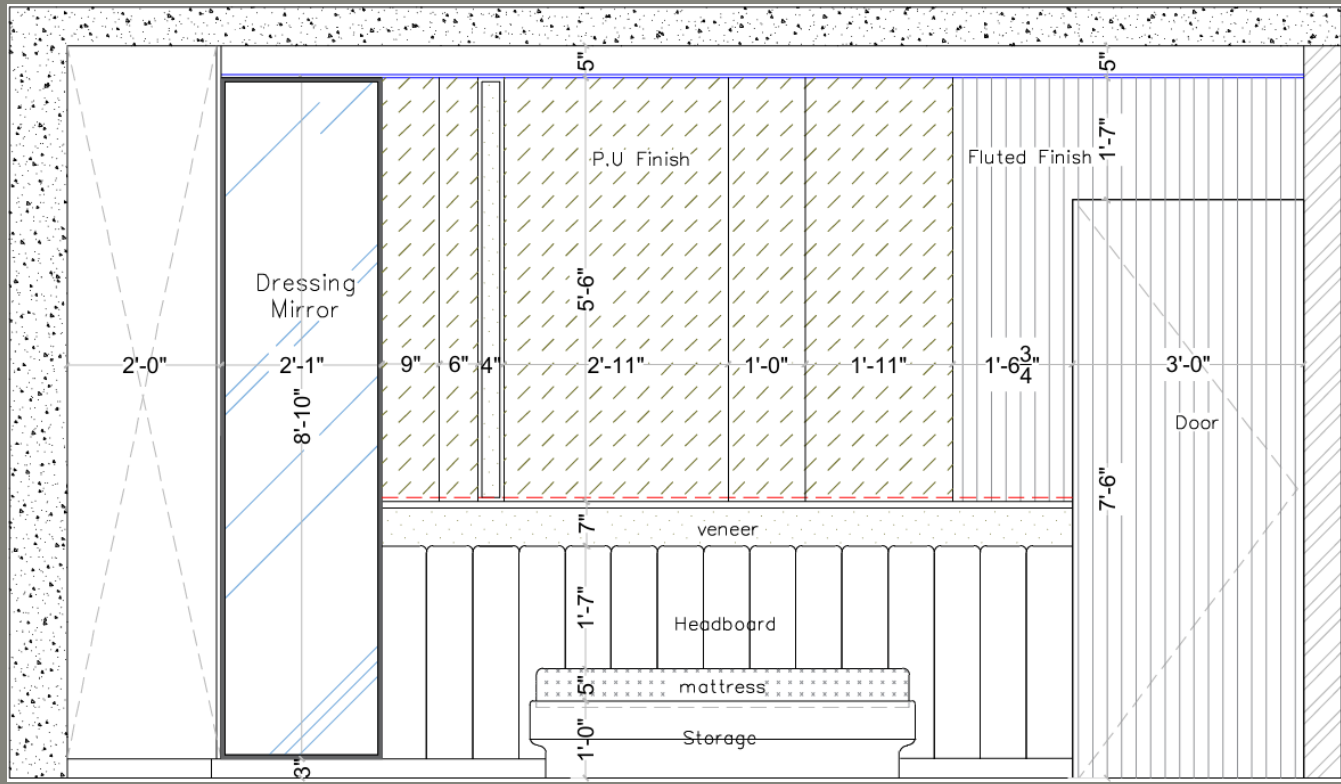

SON'S BEDROOM



SON'S BEDROOM



SON'S BEDROOM

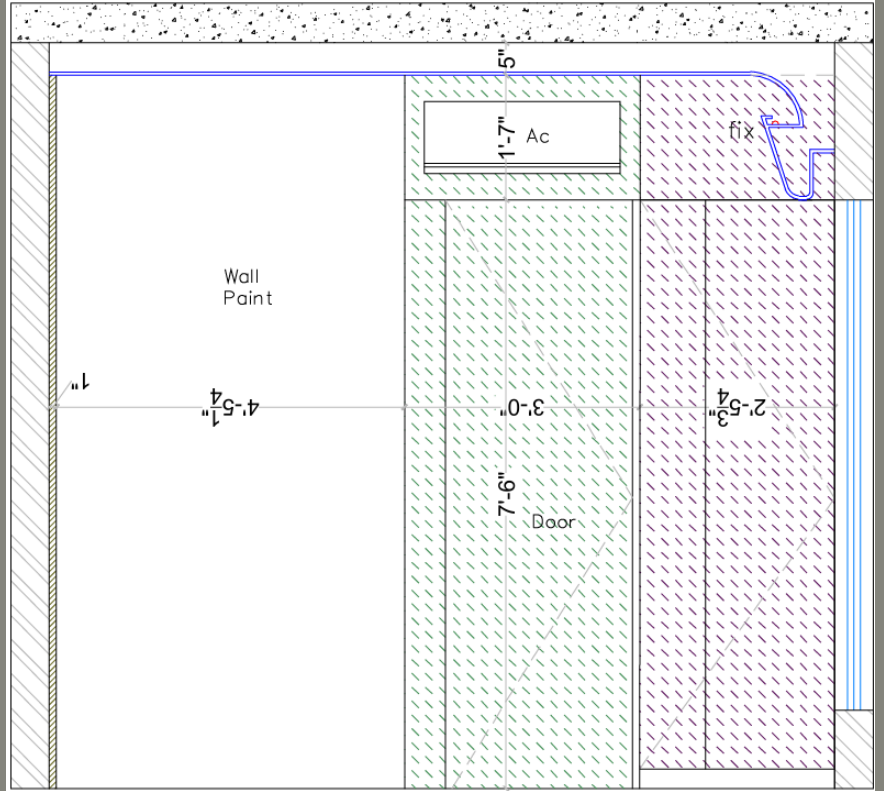
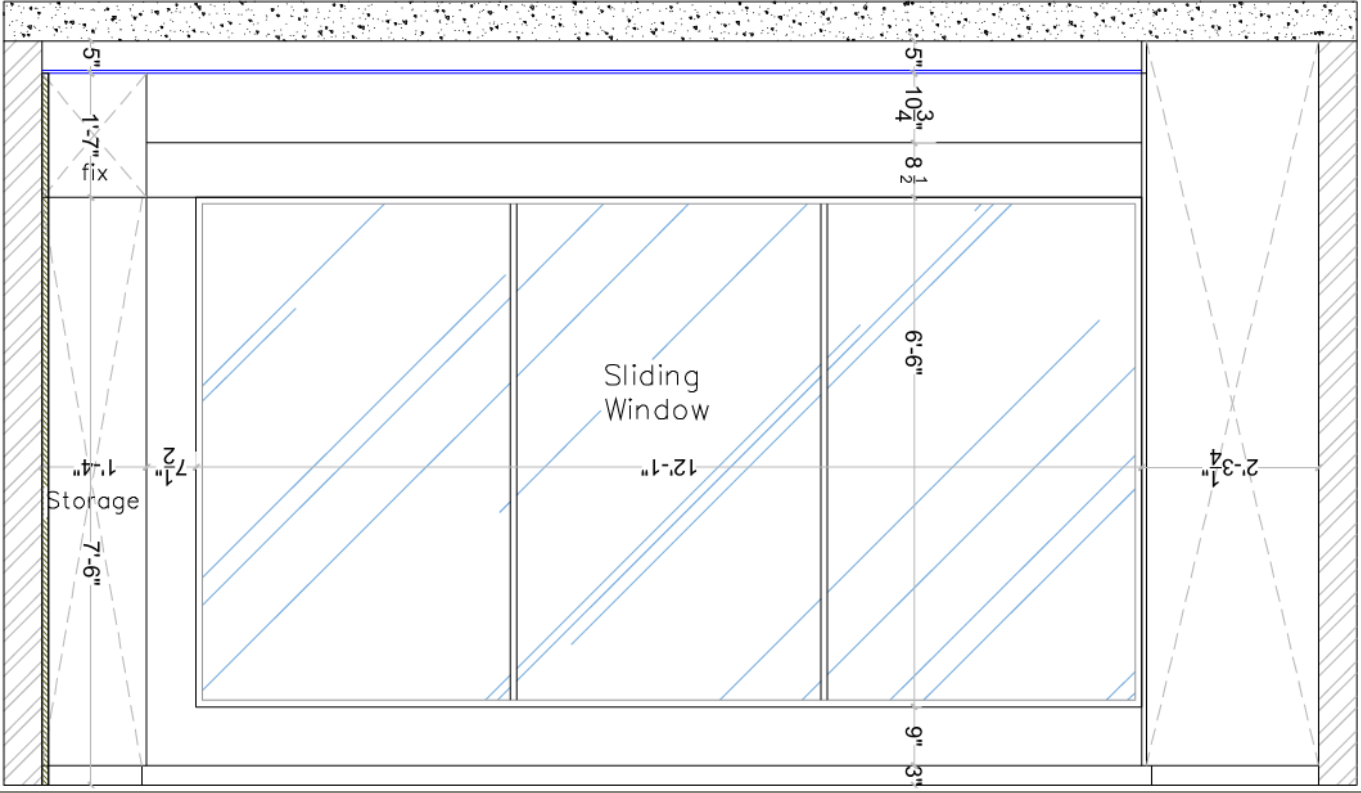

SON'S BEDROOM



PARENTS BEDROOM

PARENTS BEDROOM

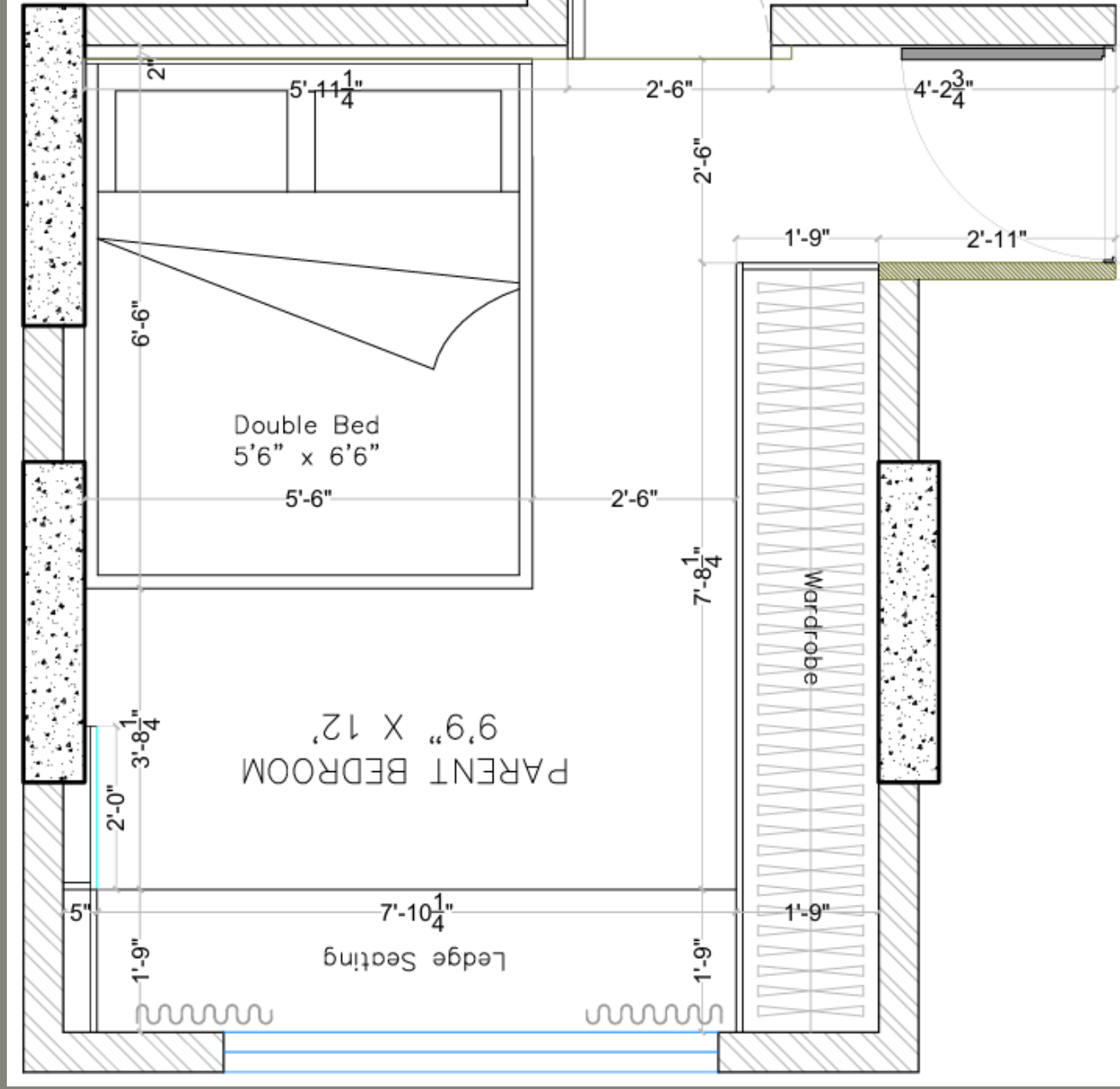

PARENTS BEDROOM

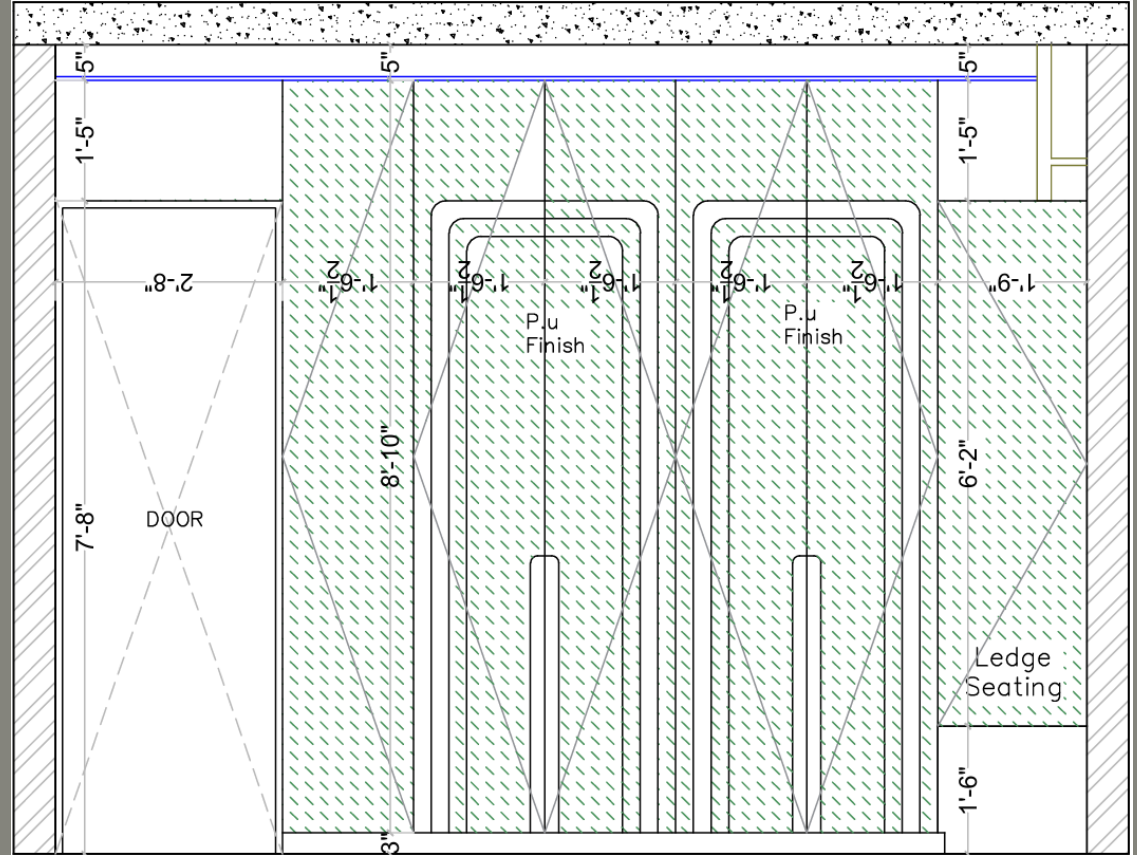
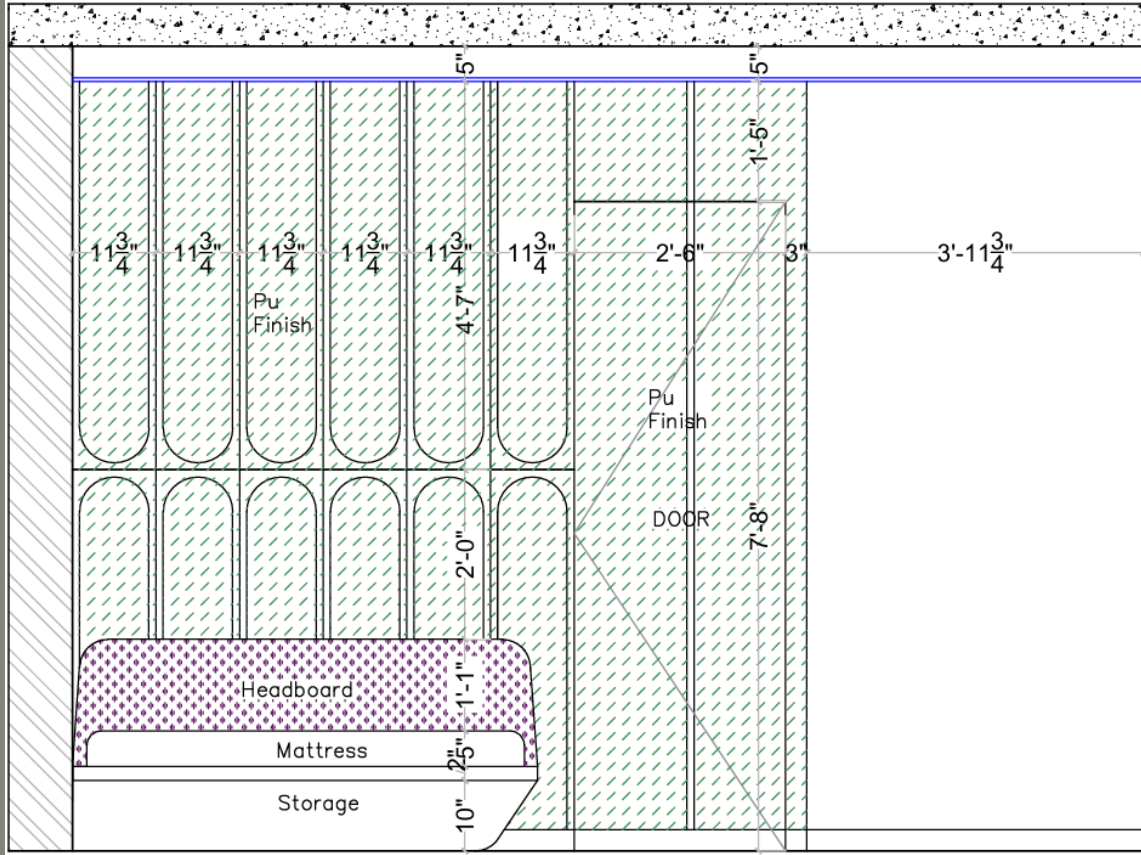

PARENTS BEDROOM



PARENTS BEDROOM



PARENTS BEDROOM

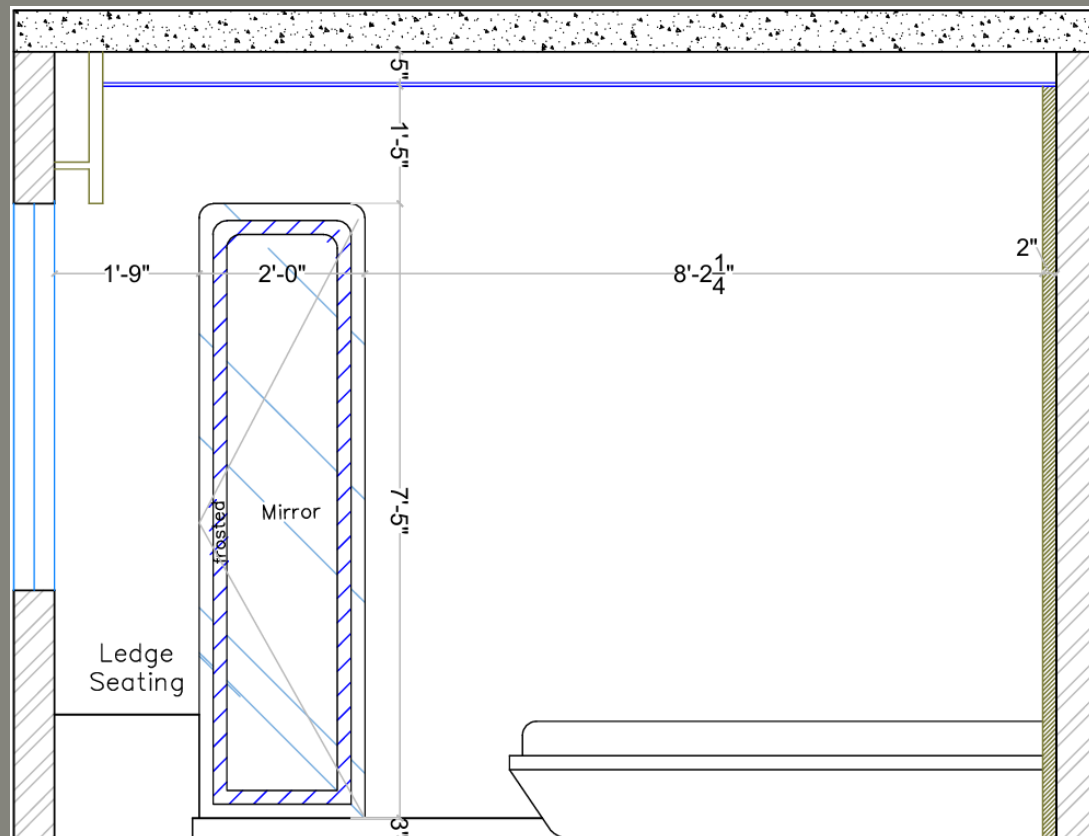
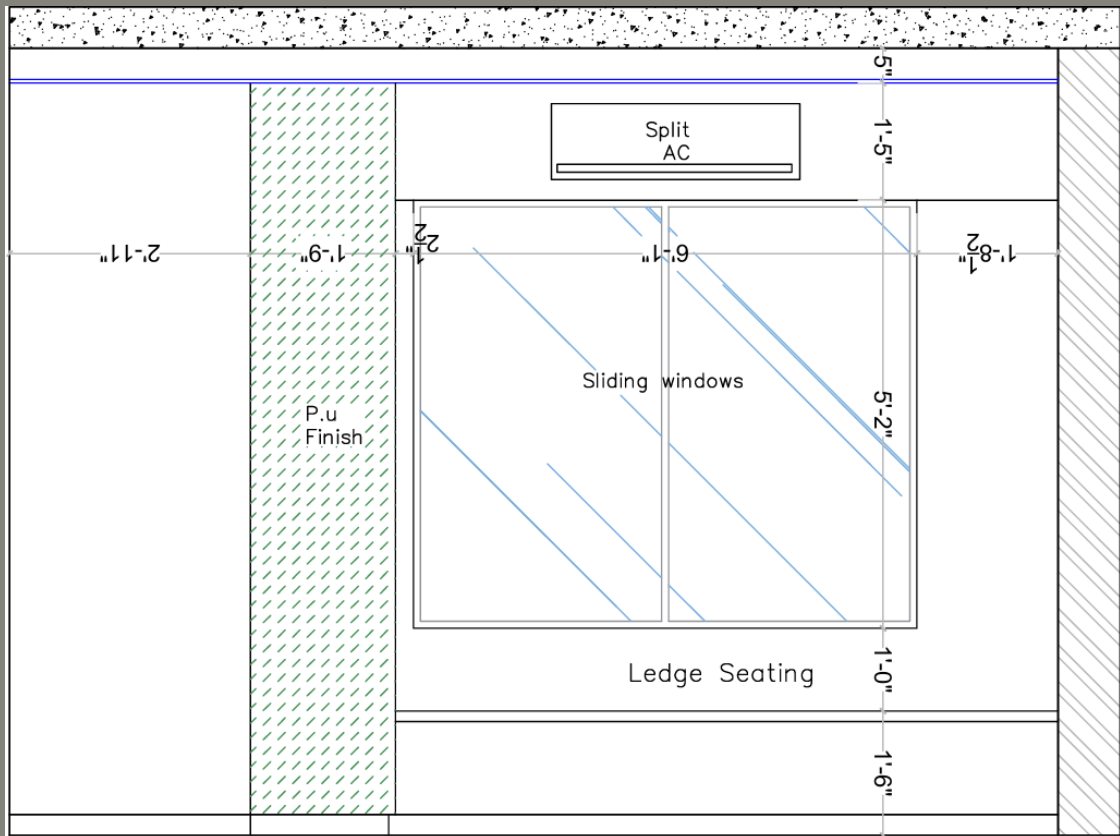

PARENTS BEDROOM



PARENTS BEDROOM



THANK YOU