

Government Publications
Registration Number (GPRN)

11-1431000-100073-01



From Creation to Protection

A Practical Guide to
Korean Design Rights & Examination

2026

Published by

Ministry of Intellectual Property (MOIP)

Government Complex Daejeon Building 4, 189, Cheongsu-ro, Seo-gu, Daejeon, 35208, Republic of Korea
<https://www.kipogo.kr/en> | moiphague@korea.kr

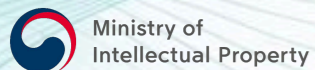

ISBN : 979-11-6884-354-7 13500
DOI : 10.8080/P9791168843547

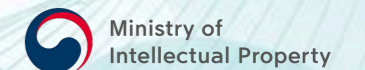

Introduction	3
Overview of the Design System in Korea	4
<ul style="list-style-type: none"> • Features of the Korean Design Protection System • Design Applications by Foreign Applicants in Korea • Recent Updates 	
2 Ways to Obtain Design Rights in Korea	6
Procedural Timeline Limits and Durations	7
Designs Which Can / Cannot be Registered in Korea	8
Partial-Substantive Examination System	9
Avoiding Lack of Clarity	10
<ul style="list-style-type: none"> • How to Write Descriptions of the Design [Example 1] • How to Write Descriptions of the Design [Example 2] • How to Prepare Drawings [1] • How to Prepare Drawings [2] 	
Partial Design	14
<ul style="list-style-type: none"> • How to Prepare Drawings of the Partial Design • Determining a Single Design with Physically Separated Parts 	
Related Designs	16
Product Indications	17
One Design Per Application	18
<ul style="list-style-type: none"> • Example of Dynamic Design & Set of Article Drawings 	
Priority Claim	20
<ul style="list-style-type: none"> • Reasons Why a Priority Claim is Not Accepted 	
Exceptions to Loss of Novelty	21
Designs Related to Images (GUIs)	22
<ul style="list-style-type: none"> • 2 Ways to Register Designs Related to Images (GUIs) 	
Miscellaneous	23

For companies and creators entering the Korean market, securing design rights is a critical step in protecting their designs.

The Republic of Korea operates a highly reliable examination system. Once a design is registered, the right remains in force for **20 years** from the filing date.

This stable and predictable protection enables right holders to operate with legal certainty and protect their design assets.

This booklet provides overseas applicants with a clear and practical [guide to obtaining design rights in Korea](#).

It outlines the key steps from filing to registration under the Korean Design Protection Act and highlights essential requirements that every applicant should be aware of.

In particular, this guide focuses on avoiding common mistakes frequently encountered by overseas applicants, such as unclear drawings, applications containing multiple designs, or misunderstandings of the “Related Design” system.

By following this guide, applicants can navigate the Korean design system more efficiently, secure stronger legal protection, and minimize unnecessary risks throughout the application process.

DISCLAIMER

This publication is for informational purposes only and does not constitute legal advice. The scope of design protection is determined by applicable laws and the official records of the Ministry of Intellectual Property (MOIP), which shall prevail in case of any inconsistency. The information reflects the status as of the date of publication and may change due to amendments to laws or examination guidelines. For the most accurate and up-to-date filing information, please refer to current laws and examination guidelines or consult a qualified patent attorney.

Date of Publication: May 2026

OVERVIEW OF THE DESIGN SYSTEM IN KOREA

Features of the Korean Design Protection System



20 Years from the Filing Date



Typefaces & GUI are Protectable

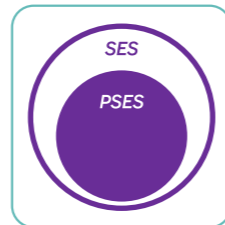

Substantive & Partial Substantive Examination

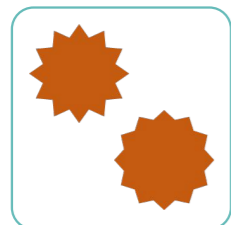

Principal & Related Designs



Accelerated Examination System



Exception to Lack of Novelty

Design Applications by Foreign Applicants in Korea

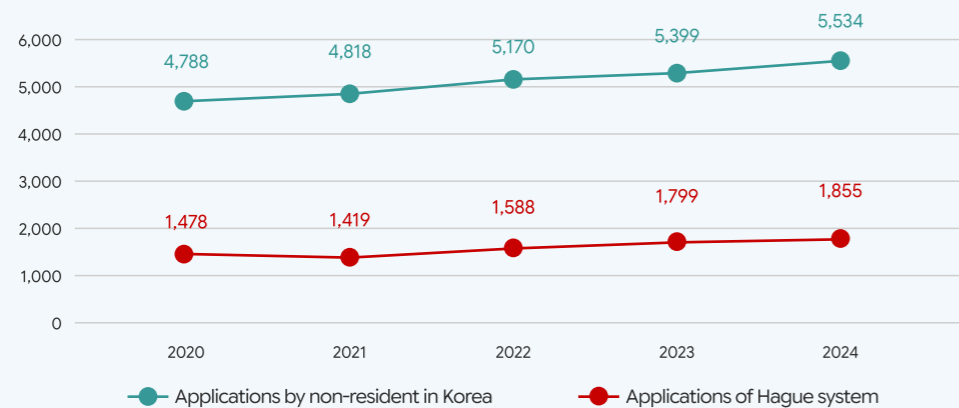

Design applications filed by foreign applicants in Korea are **consistently growing**. Likewise, the number of international design applications designating Korea under the Hague System has continued to increase, reinforcing Korea's position as a major destination for international design protection.

Recent Updates

1 Rationalization of Similarity Criteria between Whole and Partial Designs

2025.06

If the scope of protection of a whole design and a partial design are **substantially similar**, the first-to-file rule under Article 46 of the Design Protection Act may apply to both designs.

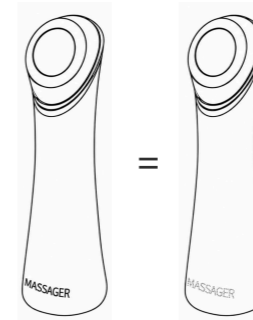

2 Establishment of Examination Standards for Combination of Vehicle Interior Design

2025.06

For vehicle interior designs composed of components such as dashboards, steering wheels, control panels, center consoles, and seats, **the combination is regarded as a single integrated design** and may be filed as one design in a single application.

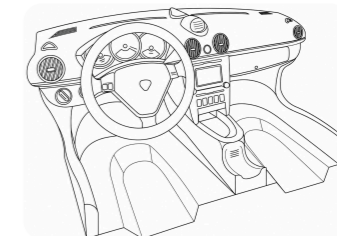

3 Rationalization of the Product Indication Requirement for Partial Designs

2025.11

Regulations for partial design applications have been relaxed by **allowing the use of the name of the whole product or a partial name including the whole product name**.

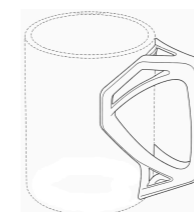

Cup

Handle of a Cup

Both indications are **acceptable**

4 Extension of the Filing Period for Related Designs

2023.06

The filing period for related designs has been extended from 1 year to **3 years** from the filing date of the principal design, allowing companies to expand the scope of their design rights, protect subsequent variations of their designs, and prevent imitation or infringement.



2 WAYS TO OBTAIN DESIGN RIGHTS IN KOREA

PROCEDURAL TIME LIMITS AND DURATIONS

Paris Route Filing (MOIP)

Designation of the Republic of Korea through the Hague System (WIPO)

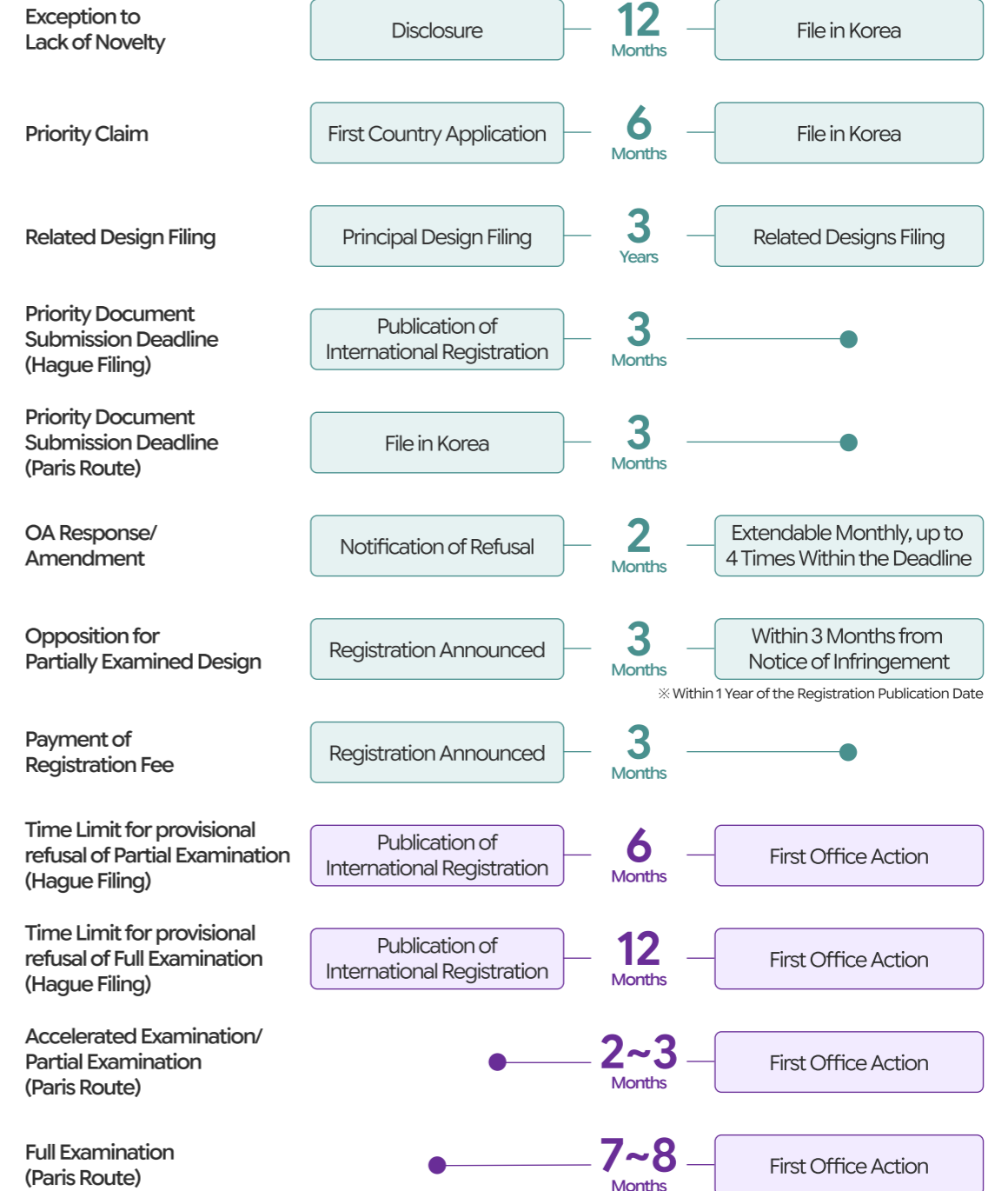
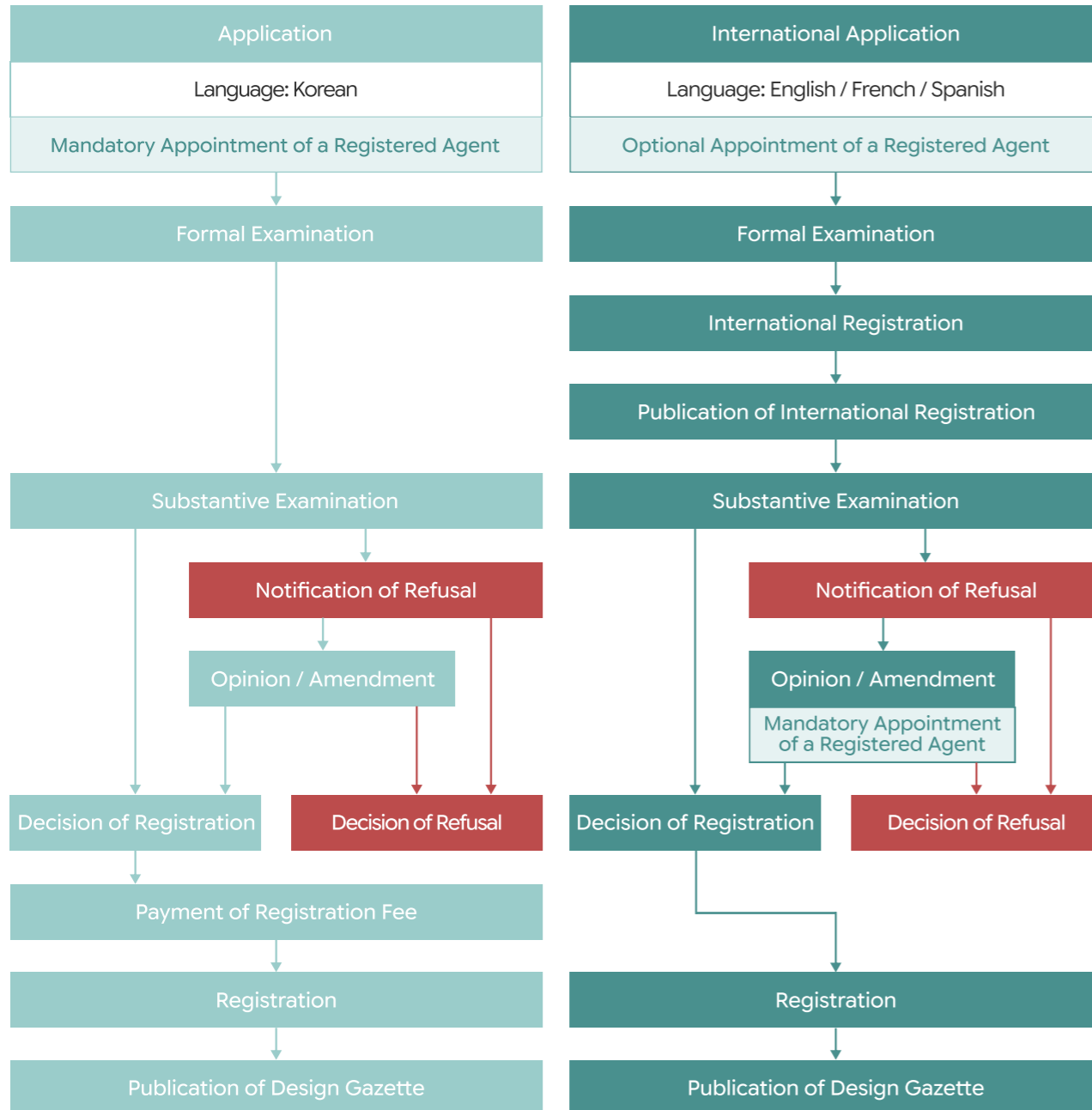

※ Examination Processing Time May Vary Depending on the Number of Applications

DESIGNS WHICH CAN BE REGISTERED IN KOREA

Food (Loc. Class 01)



30-1258402

However, products that do not have a fixed form, (powder or cooked food that cannot be made in an identical shape), cannot be registered.

Fabric (Loc. Class 05)



30-1339101

A pattern that can be applied to various articles, is not regarded as an article itself. Therefore it must be filed as "Package", "Fabric", or "Label" etc.

Display Panel in which GUI is Indicated (Loc. Class 14)



30-1252222

Poster/ Sticker/Label (Loc. Class 19)



30-1217226

Partial Design



30-1215471

Clothes (Loc. Class 02)



30-1180020

Even if handicrafts cannot be reproduced in exactly the same form, they can be registered as long as they maintain a certain degree of consistency in appearance.

Environmental Design (Loc. Class 25)

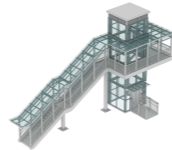

30-1300503

Street facilities that are manufactured in factories, transported, and installed are eligible for registration.

Icon (Loc. Class 14)



30-1293616

Typefaces (Loc. Class 18)



30-0731933

Vehicle Interior Compartment (Loc. Class 12)

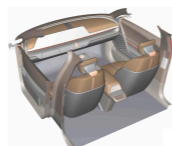

30-1227756

DESIGNS WHICH CANNOT BE REGISTERED IN KOREA

Natural Objects



Light



Pattern (without applied object)



Design against Public Morals



Interior



Buildings requiring Construction



PARTIAL SUBSTANTIVE EXAMINATION SYSTEM

In Korea, certain articles are examined under the Partial-Substantive Examination System (PSES), which provides faster registration for designs with short product cycles. Articles eligible for PSES are limited to the following Locarno classes:

Class 01	Class 02	Class 03	Class 05	Class 09	Class 11	Class 19
Foodstuffs	Articles of clothing & haberdashery	Travel goods, cases, parasols, & personal belongings not elsewhere specified	Textile piece goods, artificial & natural sheet material	Packages & containers for the transport or handling of goods	Articles of adornment	Stationery & office equipment, artists' & teaching materials

CAUTION

When filing a design application in Korea via the Paris route, if an article subject to SES (Substantive Examination System) is filed under the PSES (Partial-Substantive Examination System), the applicant must amend the classification and switch the application to the SES. Otherwise, the application may be refused. The same applies where an article subject to PSES is filed under the SES.

AVOIDING LACK OF CLARITY

| How to Write Descriptions of the Design [Example 1]

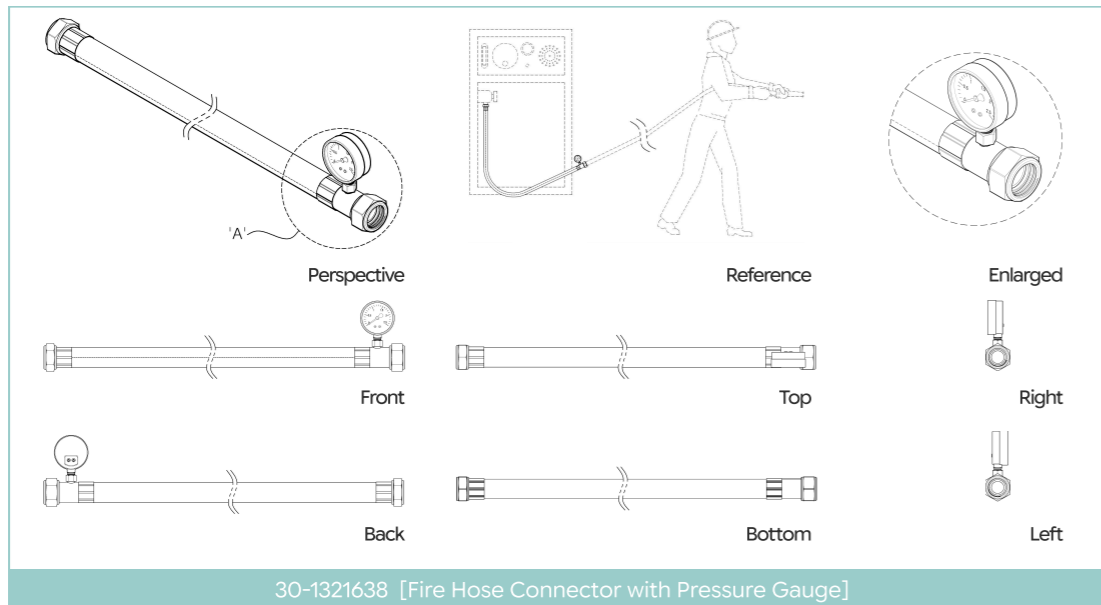

1. The material of the design is metal, rubber, and resin.
2. It is used by connecting it to a fire hose for extinguishing fires.
3. The present design features a transparent window on the front of the pressure gauge, allowing the inside to be visible.
4. The dotted lines in the drawings represent contour lines, while the dash-dot lines indicate an omitted portion, the omitted length being 70cm.
5. [Reproduction 1] is a perspective view, [Reproduction 2] is a front view, [Reproduction 3] is a back view, [Reproduction 4] is a top view, [Reproduction 5] is a bottom view, [Reproduction 6] is a left view, [Reproduction 7] is a right view, [Reproduction 8] is an enlarged view of part "A", [Reproduction 9] is a reference view showing the state of use.

6. ~~The pressure gauge operates by converting the force of the fluid pressure into mechanical movement. When water pressure enters the gauge, it acts on an elastic element, causing it to deform and move internal mechanical linkages.~~
(Deletion is recommended)

- ▶ Descriptions of material and use may be added if deemed necessary.
- ▶ A description of transparency is required unless it is apparent from the drawings. (e.g. spectacles)
- ▶ Broken lines and omitted lengths must be clearly indicated when deemed necessary.
- ▶ Explanations of the drawings must be added if deemed necessary.

▶ Descriptions of technical or functional elements that go beyond the scope of the design are unnecessary.

| How to Write Descriptions of the Design [Example 2]

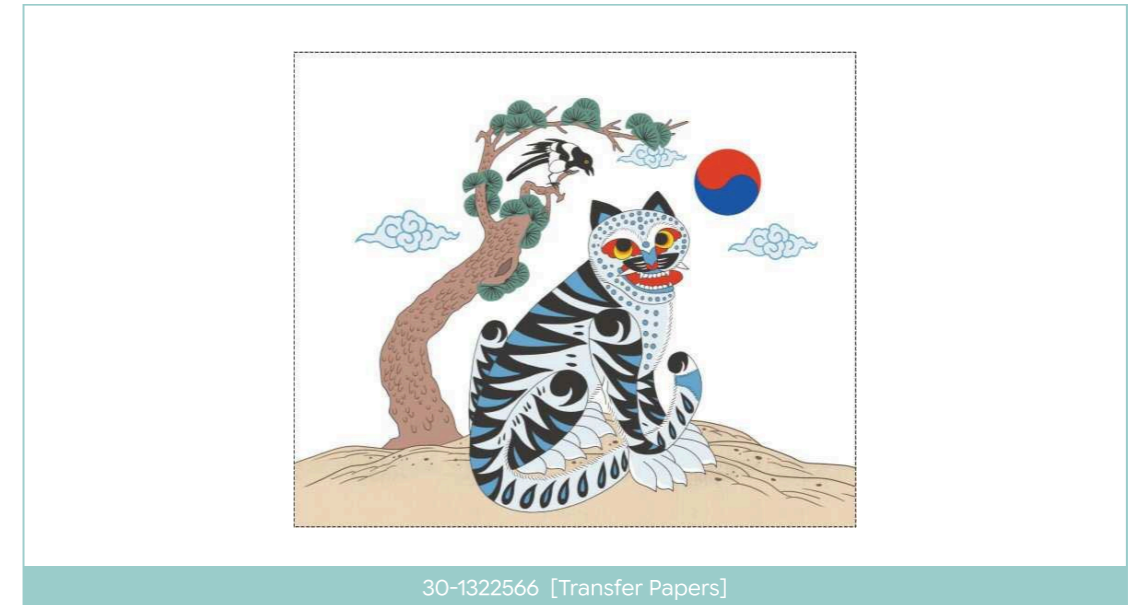

1. The material of the design is pigment, resin, or vinyl.
2. The design can be attached or adhered to packaging containers, documents, business cards, stationery.. etc or used through printing or heat transfer.
3. [Reproduction 1] shows the surface view of the design, and the rear view is omitted as it has no shape.
4. The portions shown in solid lines and the colored portions are the parts for which partial design registration is sought.
5. The uncolored areas in [Reproduction 1] are white.

▶ In the case of a flat design, the rear view may be omitted when identical, rarely visible in use, or it has no surface ornamentation provided that the reason for omission is stated.

▶ The method used to identify the claimed portion of the partial design in the representation is required to be stated if deemed necessary.

▶ If uncolored portions appear in a color drawing, they may be interpreted as transparent or hollow areas. It is recommended that an explanation is added.

If you encounter difficulties in preparing the application form, you are advised to search for a similar product on the KIPRIS* website and refer to recent design registrations.

▶ Since laws and examination guidelines are subject to change, it is recommended to refer to the most recent registration gazette for products similar to the design you intend to apply for.

* KIPRIS is a public IP information search service. (www.kipris.or.kr)

AVOIDING LACK OF CLARITY

I How to Prepare Drawings [1]

It is recommended to submit a perspective view along with the six orthographic views (front, rear, left, right, top, and bottom).

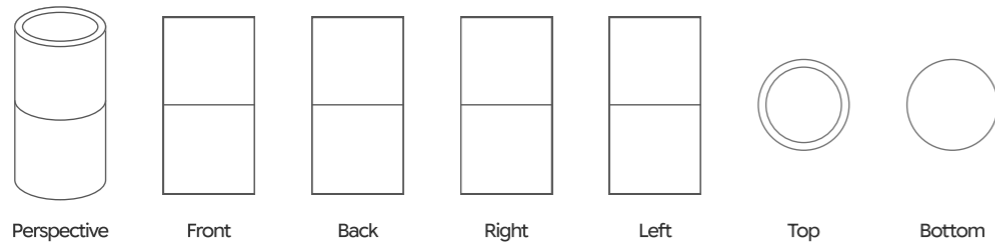

Ideal Basic Submission Format

In some cases, it is difficult to clearly identify the essential features of a design based on the submitted drawings alone.

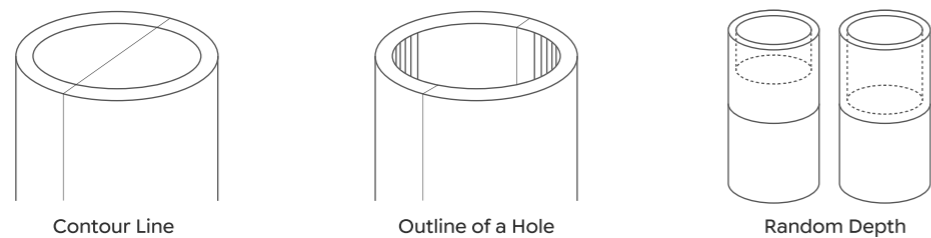

Case 1

Case 2

Case 3

In this case, additional drawings can be used to illustrate the scope of the rights more clearly.

Cross-sectional views, exploded views, and enlarged views that form part of the claimed design can be submitted as general reproduction views. If it is difficult to determine the exact location of a section of the design that has been cropped or enlarged based on the drawing alone, additional explanations may be required. Drawings showing elements other than the claimed design, such as "state of use drawings", should be submitted as reference drawings.

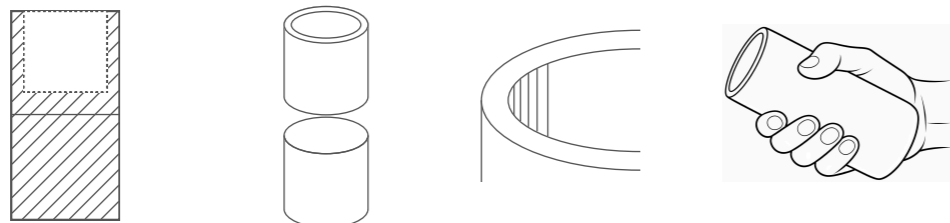

Cross Sectional View

Exploded View

Enlarged View

Reference View

I How to Prepare Drawings [2]

For designs that are large or heavy, the bottom view may be omitted if it is rarely visible during use, and does not affect the overall aesthetic impression. The reason for the omission is required to be indicated in the description if necessary. (e.g. Bottom view is omitted as this design involves a heavy article).

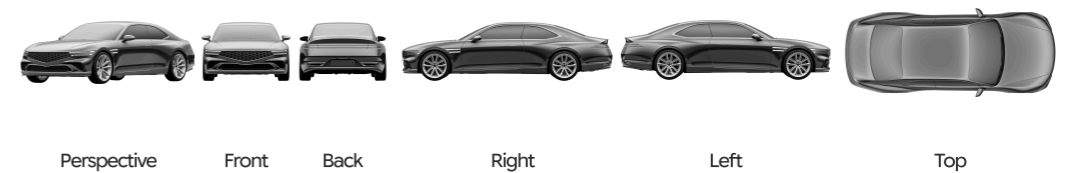

30-1331376 [Automobile]

Excessive shading that could be mistaken for a printed pattern on the surface may be grounds for rejection.



U.S. D688245S [Computer Mouse]

30-0955305 [Computer Mouse]

30-0597928 [Computer Mouse]

Objects other than the claimed design should not appear in the drawings. However, a body part or a mannequin may be included when necessary to show clothing or accessories, provided that it is clearly distinguishable from the claimed design. The reason for the inclusion should be indicated in the description.



30-2021-0025283 [Mask]

30-1060767 [Toe Corrector]

30-1198766 [Pet Carriers]

PARTIAL DESIGN

Only parts where the unit of creation is clearly defined can be recognized as falling within the scope of design rights. By clearly defining the scope of rights, stronger design protection becomes possible.

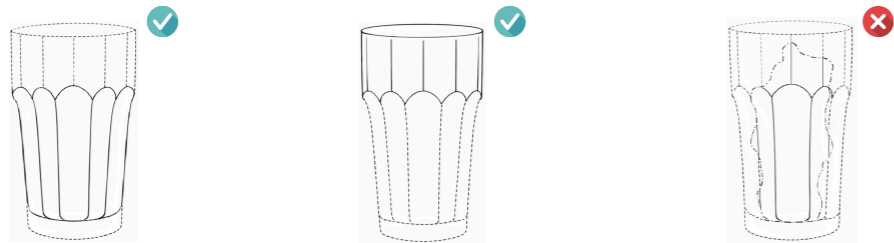

Example of Recognizable Independent Unit of Creation

How to Prepare Drawings of the Partial Design

The unclaimed portion must be shown in color in photographs, or indicated by broken lines in line drawings. The method used to specify the partial design must be explained in the description. (e.g. The broken lines shown in the drawings form no part of the claimed design)

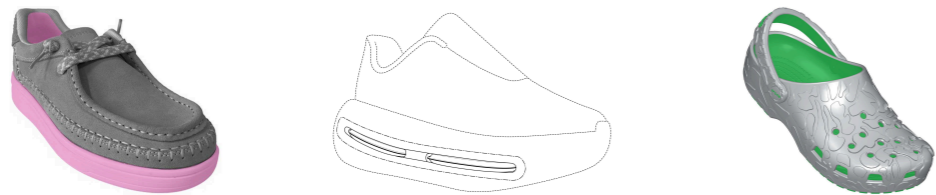

30-1329668 [Footwear]

30-1333923 [Footwear]

30-1279362 [Footwear]

Where the boundary of the claimed portion is unclear, it must be indicated by a dash-dot line or an equivalent method.

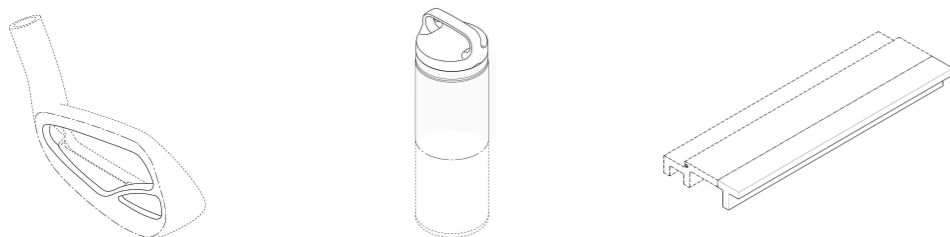

30-1073378 [Golf Club Head]

30-1340273 [Beverage Container]

30-1163485 [Door Frame Profile]

Determining a Single Design for Physically Separated Parts

Even if the claimed portion appears physically separated in the drawings, they can be considered a single design if they are recognized as integrated in one design creation.

(1) Cases where Formal Unity is Recognized

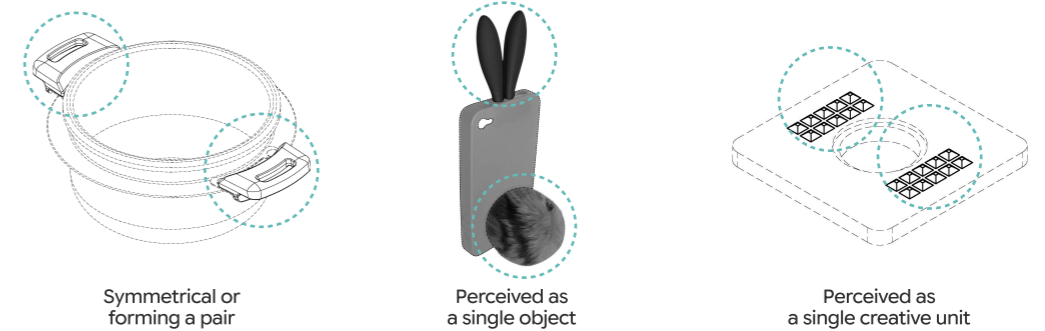

Symmetrical or forming a pair

Perceived as a single object

Perceived as a single creative unit

30-1322526 [Cauldrons]

30-0721123 [Phone Case]

30-1268511 [Fastening Bracket]

(2) Cases where Functional Unity is Recognized

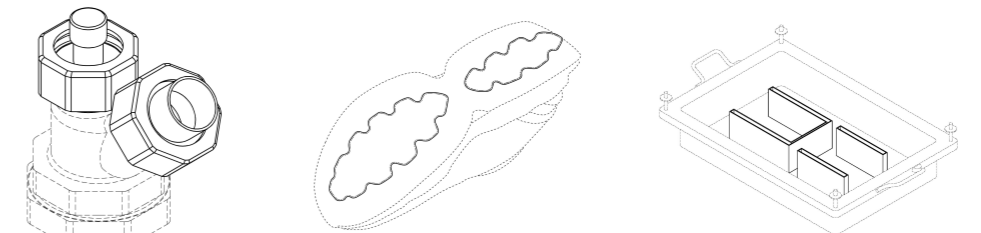

Each part functions to connect pipes

Each part functions to prevent slipping

Each part functions to inhale smoke

30-1298591 [Sink Drain connector]

30-1288205 [Footwear]

30-1266490 [Charcoal Braziers]

CAUTION

A typeface is only protected as a set of designs or a set of articles and is not eligible for protection as a partial design.

RELATED DESIGNS

A design application is generally refused if a similar design filed or registered earlier exists prior to the filing date of the application. However, a design right may still be granted by designating the earlier design as the "Principal design." This is known as the Related Design System. The requirements for Related Designs are as follows.

- ① The applicant must be identical.
- ② The designs must be similar.
- ③ The subsequent design must be filed within 3 years from the filing date of the Principal Design.

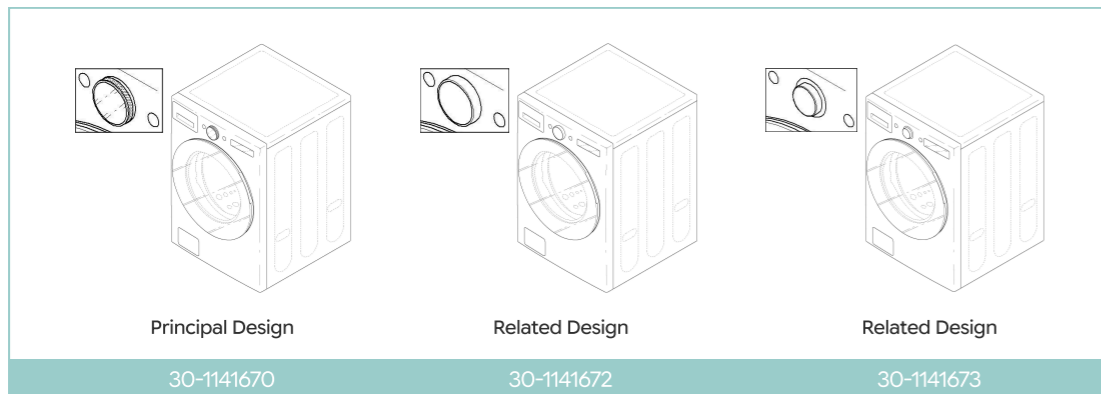

NOTE

- ✓ In principle, a whole design and a Partial design cannot be registered as a Principal and Related designs. However, where the unclaimed portion of the Partial Design is visually negligible and does not affect the overall aesthetic impression compared with the whole design, the two designs may be regarded as similar. In such cases, a later-filed application by the same applicant, or an application filed on the same date, may be registered as a Related Design.

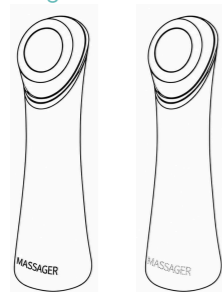



CAUTION

- ❗ A Principal design must originate from either an application filed or registered directly with the MOIP, or from a Hague System application designating Korea. **Designs filed in jurisdictions other than Korea are not eligible to serve as the Principal Design.**
- ❗ Depending on which designs are designated as the Principal Design and Related Designs, grounds for refusal may arise, and the acquisition of rights may be delayed due to amendment procedures. Therefore, particular care should be taken when making the designation.
- ❗ A design cannot designate itself as the Principal Design. A design may be designated only in relation to another design filed by the same applicant within 3 years or filed on the same date.

PRODUCT INDICATIONS

✓ Guideline

- ✓ When filing directly with MOIP, please refer to the [\[Notification on the List of Articles by Design Class\]](#) (Korean and English are provided in parallel for reference.) 
- ✓ When filing through the Hague System using English product names, please refer to WIPO's online product designation resources. 
- ✓ If the product name is not listed, an **appropriate name commonly used in the market** may be designated, provided that its use and function can be clearly understood.
- ✓ If a commonly used generic product name has not yet been established in actual trade, a designation that minimally specifies the intended use of the product such as "component for ○○○ use" may be accepted. However, broadly phrased names that do not specify the intended use cannot be registered.
e.g) "Component for construction" (X) → "Component for window frame" (O)
- ✓ Generic technical expressions like "foldable", "modular", or "portable" may be accepted when they are commonly used.

✗ Unclear Product Indications

- ❗ Lack of clarity regarding use
e.g) "Hinge" (X) → "Hinge for spectacles" (O)
- ❗ Use of trademarks, or personal names
e.g) "iphone case" (X), "Da Vinci chair"(X) → "Smartphone case" (O), "Chair" (O)
- ❗ Use of terms describing effects, or performance
e.g) "High-end telephone" (X), "Health massager"(X) → "Telephone" (O), "Massager" (O)
- ❗ Inclusion of shape, pattern, or color in the name
e.g) "Postbox-shaped microwave" (X), → "Microwave" (O)
- ❗ Inclusion of material names
e.g) "Wooden desk" (X), "Plastic cup" (X) → "Desk" (O), "Cup" (O)

ONE DESIGN PER APPLICATION

Each design unit should be filed in a separate design application except for the following:

(1) Traded as a single unit



(2) Form a single configuration

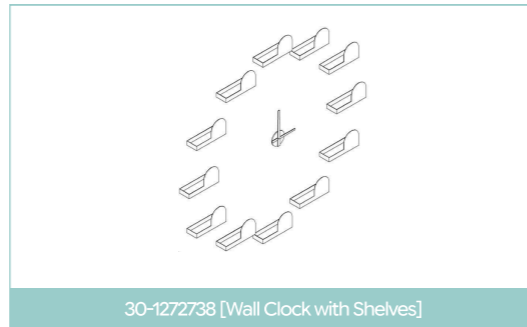

(3) Multiple components defined by an outline



(4) Dynamic design depicting changes

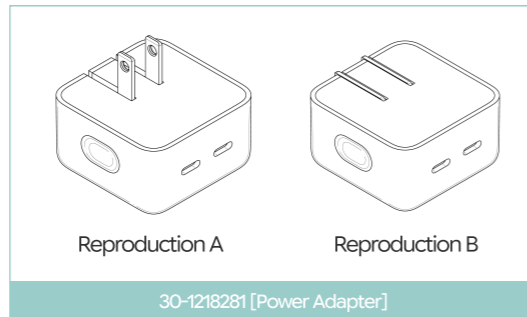

NOTE

- The appearances before and after the change must be submitted in the form of [Reproduction A] and [Reproduction B], respectively.
- If there is no transitional process, or if the transitional process lacks consistency and uniformity, the application may be refused.

(5) Set of Articles



REQUIREMENTS

- 1) Two or more articles should be used **simultaneously** in practice or concept.
- 2) The set must possess overall **unity**, with a consistent expression of shape, pattern, or color across the individual articles.
- 3) A set of drawings showing the overall appearance should be submitted, along with a separate set of drawings for each component article.
e.g) fork, spoon, and knife.

Example of Dynamic Design & Set of Article Reproductions

(1) Image Design

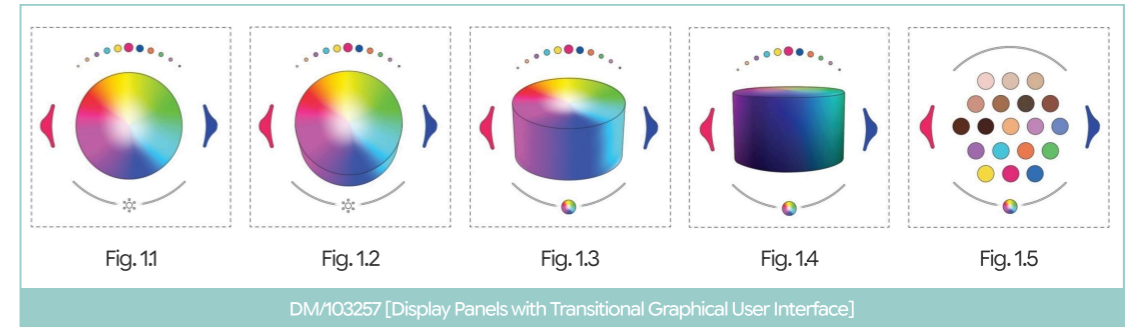

(2) Dynamic Design



(3) Set of Articles

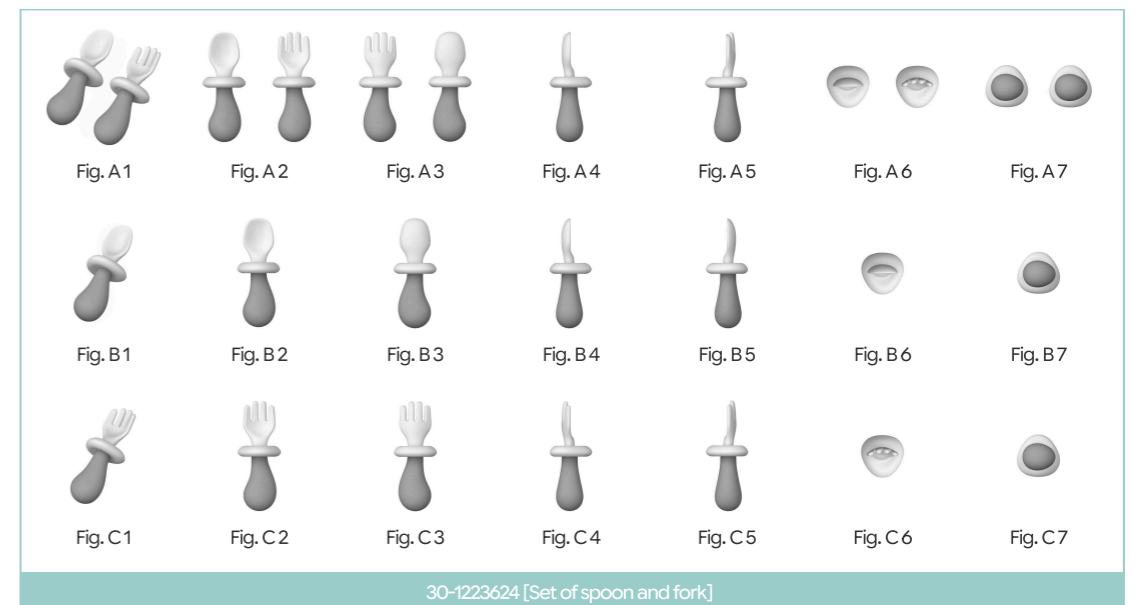

PRIORITY CLAIM

If a priority claim is properly made, designs disclosed during the period between the initial filing and the Korean filing will not adversely affect the applicant. However, the priority claim is subject to specific procedural requirements; the **representations*** (including scope) and the **applicant**** filed in Korea must be identical to that of the first-filed application.

TIME LIMITS AND PROCEDURES

Direct Filing	Hague System Filing
<ol style="list-style-type: none"> 1) Applicant must declare priority claim at the time the application is filed, and may amend related documents within 3 months from the filing date. For applications filed through the Hague System, such changes may be made within 3 months from the date of international publication. 2) Application must be submitted to the MOIP within 6 months from the filing date of the first application filed in another country. 3) Priority document must be submitted within 3 months from the Korean filing date. 4) Instead of submitting a copy of the priority document, the applicant may provide a DAS code. 	<ol style="list-style-type: none"> 3) Priority document must be submitted either to WIPO at the time of filing the international application when Annex V is used, or directly to the MOIP within 3 months from the date of international publication.

REASONS WHY PRIORITY CLAIM IS NOT ACCEPTED

* Representations are not identical

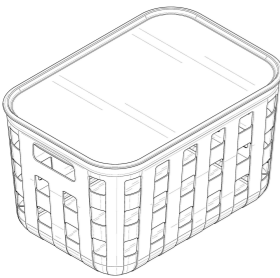
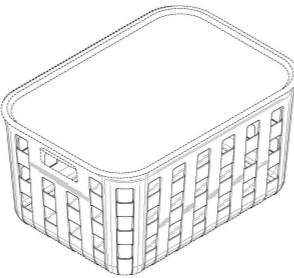
Priority claim	International Application
	
AU202410350	DM/240051 [Laundry Basket]

**Applicants are not identical

Priority claim	International Application
纳恩博(常州)科技有限公司 (常州) = (Changzhou)	Ninebot(Beijing) Tech Co., Ltd. (Beijing) = (北京)
CN202030675427.8	DM/216600 [Electric Bicycle]

EXCEPTIONS TO LOSS OF NOVELTY

Designs disclosed or made publicly available before filing are not eligible for registration. However, applying this rule too strictly may disadvantage genuine creators who could not file immediately due to certain circumstances. Therefore, the Act provides an exception to lack of novelty, allowing a disclosed design to be treated as undisclosed provided that the prescribed requirements and procedures are satisfied.

TIME LIMITS AND PROCEDURES

Direct Filing	Hague System Filing
<ol style="list-style-type: none"> 1) Application must be filed within 12 months from the date on which the design was disclosed. 2) The exception to lack of novelty may be claimed at the time of filing, during examination, and in subsequent opposition, trial, and litigation proceedings. 	

INFORMATIVE REQUIREMENTS IN SUPPORTING DOCUMENTS



NOTE

- Whether the filed design is identical or similar to the disclosed design indicated in the supporting documents is not considered.
- If the same design has been disclosed multiple times, it is sufficient to invoke the exception with respect to the earliest disclosure.

CASE EXAMPLE

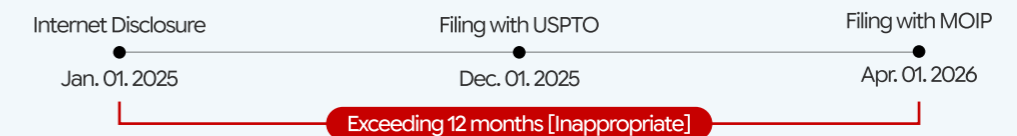

In a design application claiming Paris Convention priority, the 12-month period for invoking the exception to lack of novelty is calculated based on the Korean filing date and does not retroactively apply to the filing date of the first application filed abroad.

CAUTION





- A design may lose novelty if it has been disclosed through various media or commercial channels (e.g. exhibitions, SNS, online sales platforms). Applicants should carefully review whether any such disclosures have occurred.
- The exception to lack of novelty does not extend to disclosures made in official IP publications (Design Protection Act, article 36). Applicants should therefore confirm whether any relevant gazettes have already been issued in foreign jurisdictions other than the Republic of Korea.

DESIGNS RELATED TO IMAGES (GUIs)

MISCELLANEOUS

2 Ways to Register Designs Related to Images (GUIs)

(1) Images (GUIs)





Images utilized for device control Used for the operation (input commands, control) of devices		Images for device operation Express the functions performed by devices (graphs, status indicators, warning lights)	
			
GUI Icons	GUI for Operating Application	GUI for Information and Communication	GUI for Displaying Information
30-1279589	30-1333895	30-1306556	30-1311791

CAUTION

- Since images are protected based on their intended use, it is **mandatory to state the intended use in the product indication or the description of the design.**

(2) Screen Designs displayed as the Parts of Articles

These designs are depicted through display parts of products such as display panels, and may only be expressed as a partial design. Therefore, the outer contour of the article must be shown in dotted lines.

			
Display Panel with Screen Design	Vehicle Display Panel With Screen Design	Watch with Screen Design	Display Panel with Screen Design
30-1326831	30-1333675	30-1254694	30-1331377



CAUTION

- The **designation of the product** must be clearly indicated in the name of product.
e.g) **Display panel** with screen design, **Watch** with screen design

NOTE

- For an **animated GUI design**, the **sequence and manner of changes** should be sufficiently **consistent** to be recognized as a single design.
- To clarify the scope of rights, the drawings should be accurately depicted and the description should provide sufficient detail.

Designs classified in Class 32 of the international classification of Locarno are not eligible for protection under the Design Protection Act of the Republic of Korea. Also, the indication of product ("Ornamentations") is inappropriate, since ornamentation itself is not regarded as an article under Article 2(1) of the Design Protection Act. However, protection may be granted if the product name and drawings are amended to products such as stickers or labels, as illustrated below.

	
"Ornamentations" Class 32-00	"Sticker" or "Label" Class 19-08
DM/088191	Example of Amendment

Information

Q: Where can I find official information about Korean design rights and examination procedures?

A: [MOIP \(Ministry of Intellectual Property\)](#)

MOIP



Q: Where can foreign applicants study Korean IP practices more deeply?

A: [IIPTI \(International Intellectual Property Training Institute\)](#)

IIPTI



Q: Is there an online database for checking Korean IP rights including designs, trademarks, and patents?

A: [KIPRIS \(Korea Intellectual Property Rights Information Service\)](#)

KIPRIS



Q: Are you interested in how the five largest design offices cooperate on design systems?

A: [ID5 \(Industrial Design 5 Offices\)](#)

ID5

